

NSS 1740.16 was Cancelled on July 25 2005.

NSS 1740.16

NOTE: Cancelled or superseded standards may remain valid on contracts after the date of the standard's cancellation or supersession – always check the contract to determine the applicability of a specific standard.

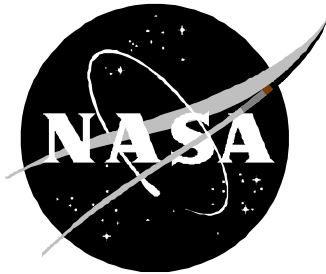

National Aeronautics and Space Administration

SAFETY STANDARD FOR HYDROGEN AND HYDROGEN SYSTEMS

**Guidelines for Hydrogen System Design, Materials
Selection, Operations, Storage, and Transportation**

Office of Safety and Mission Assurance
Washington, DC 20546

PREFACE

This safety standard establishes a uniform Agency process for hydrogen system design, materials selection, operation, storage, and transportation. This standard contains minimum guidelines applicable to NASA Headquarters and all NASA Field Centers. Centers are encouraged to assess their individual programs and develop additional requirements as needed. "Shalls" and "musts" denote requirements mandated in other documents and in widespread use in the aerospace industry.

This standard is issued in loose-leaf form and will be revised by change pages.

Comments and questions concerning the contents of this publication should be referred to the National Aeronautics and Space Administration Headquarters, Director, Safety and Risk Management Division, Office of the Associate for Safety and Mission Assurance, Washington, DC 20546.

A handwritten signature in black ink, appearing to read "Frederick D. Gregory". The signature is written in a cursive style with a long, vertical tail on the final letter.

Frederick D. Gregory
Associate Administrator for
Safety and Mission Assurance

Effective Date: Feb.12, 1997

ACKNOWLEDGMENTS

The NASA Hydrogen Safety Handbook originally was prepared by Paul M. Ordin, Consulting Engineer, with the support of the Planning Research Corporation. The support of the NASA Hydrogen-Oxygen Safety Standards Review Committee in providing technical monitoring of the standard is acknowledged. The committee included the following members:

William J. Brown (Chairman)	NASA Lewis Research Center Cleveland, OH
Harold Beeson	NASA Johnson Space Center White Sands Test Facility Las Cruces, NM
Mike Pedley	NASA Johnson Space Center Houston, TX
Dennis Griffin	NASA Marshall Space Flight Center Alabama
Coleman J. Bryan	NASA Kennedy Space Center Florida
Wayne A. Thomas	NASA Lewis Research Center Cleveland, OH
Wayne R. Frazier	NASA Headquarters Washington, DC

The special contributions provided by Grace Ordin are noted. Also acknowledged are the contributions provided by Carol A. Vidoli and, particularly, William J. Brown of NASA Lewis Research Center for their aid in reviewing, organizing, and editing this handbook; Fred Edeskuty of Los Alamos National Laboratory for information on slush hydrogen, and William Price of Vitro Corporation for his revision. This revision was prepared and edited by personnel at the NASA Johnson Space Center White Sands Test Facility. This document was extensively reviewed by experts at the various NASA centers, and their comments and suggestions were instrumental in making the manual as complete and accurate as possible. The expertise of these professionals in the area of hydrogen system hazards, materials, selection, design, and operation is gratefully acknowledged.

ABOUT THIS DOCUMENT

This document and its companion document, Safety Standard for Oxygen and Oxygen Systems (NSS 1740.15 1996), are identified as Tier 2 Standards and Technical Requirements in the NASA Safety and Documentation Tree (NHB 1700.1 1993). The information presented is intended as a reference to hydrogen design and practice and not as an authorizing document. The words “shall” and “must” are used in this document to indicate a mandatory requirement, and the authority for the requirement is given. The words “should” and “will” are used to indicate a recommendation or that which is advised but not mandatory.

The information is arranged in an easy-to-use format. The reader will find the following useful to note:

- A numbered outline format is used so information can be readily found and easily cited.
- An index is provided in Appendix H to assist the reader in locating information on a particular topic.
- Acronyms are defined when introduced, and a tabulation of acronyms used in the document is provided in Appendix F.
- The figures and tables referenced in the text are located in the appendices.
- All sources are referenced so the user can verify original sources as deemed necessary. References cited in the main body of the text can be found in Chapter 10, and references introduced in an appendix is cited in that appendix. The latest revisions of codes, standards, and NASA directives should be used when those referenced are superseded.
- The International System of Units (SI) is used for primary units, and US Customary units are given in parentheses following the SI units. Some of the tables and figures contain only one set of units.

TABLE OF CONTENTS

Paragraph		Page
CHAPTER 1: BASIC HYDROGEN SAFETY GUIDELINES		
100	SCOPE	1-1
101	INTRODUCTION	1-1
102	APPLICABLE DOCUMENTS	1-5
103	PERSONNEL TRAINING	1-5
104	USE OF INHERENT SAFETY FEATURES	1-7
105	CONTROLS	1-9
106	FAIL-SAFE DESIGN	1-10
107	SAFETY	1-10
108	WAIVER PROVISIONS	1-11
CHAPTER 2: PROPERTIES AND HAZARDS OF HYDROGEN		
200	TYPICAL PROPERTIES	2-1
201	TYPES OF HAZARDS	2-3
202	FLAMMABILITY AND IGNITION OF HYDROGEN	2-14
203	DETONATION	2-24
204	CHARACTERISTIC PROPERTIES OF GH ₂	2-29
205	CHARACTERISTIC PROPERTIES OF LH ₂	2-35
206	CHARACTERISTIC PROPERTIES OF SLH ₂	2-36
CHAPTER 3: MATERIALS FOR HYDROGEN SERVICE		
300	CONSIDERATIONS FOR MATERIALS SELECTION	3-1
301	HYDROGEN EMBRITTLEMENT	3-7
302	THERMAL CONSIDERATIONS IN MATERIALS SELECTION	3-11
CHAPTER 4: HYDROGEN FACILITIES		
400	SAFETY POLICY	4-1
401	SAFETY REVIEWS	4-2
402	GENERAL FACILITY GUIDELINES	4-6

TABLE OF CONTENTS (continued)

Paragraph		Page
403	BUILDINGS AND TEST CHAMBERS	4-12
404	CONTROL ROOMS	4-18
405	LOCATION AND QUANTITY-DISTANCE GUIDELINES	4-19
406	EXCLUSION AREAS	4-29
407	PROTECTION OF HYDROGEN SYSTEMS AND SURROUNDINGS	4-32
408	FIRE PROTECTION	4-36
409	DOCUMENTATION, TAGGING, AND LABELING OF STORAGE VESSELS, PIPING, AND COMPONENTS	4-39
410	INSTRUMENTATION AND MONITORING	4-42
411	EXAMINATION, INSPECTION, AND RECERTIFICATION	4-46
CHAPTER 5: HYDROGEN STORAGE VESSELS, PIPING, AND COMPONENTS		
500	GENERAL REQUIREMENTS	5-1
501	STORAGE VESSELS	5-3
502	PIPING SYSTEMS	5-15
503	COMPONENTS	5-25
504	OVERPRESSURE PROTECTION OF STORAGE VESSELS AND PIPING SYSTEMS	5-43
505	HYDROGEN VENT AND FLARE SYSTEMS	5-49
506	CONTAMINATION	5-55
507	VACUUM SYSTEM	5-60
CHAPTER 6: HYDROGEN AND HYDROGEN FIRE DETECTION		
600	HYDROGEN DETECTION	6-1
601	HYDROGEN FIRE DETECTION SYSTEMS	6-9
CHAPTER 7: OPERATING PROCEDURES		
700	GENERAL POLICY	7-1

TABLE OF CONTENTS (continued)

<u>Paragraph</u>		<u>Page</u>
701	STORAGE AND TRANSFER PROCEDURES	7-10
CHAPTER 8: TRANSPORTATION		
800	GENERAL	8-1
801	TRANSPORT ON PUBLIC THOROUGHFARES	8-3
802	TRANSPORT ON SITE CONTROLLED THOROUGHFARE	8-6
803	TRANSPORTATION EMERGENCIES	8-10
CHAPTER 9: EMERGENCY PROCEDURES		
900	GENERAL	9-1
902	TYPES OF EMERGENCIES	9-4
902	ASSISTANCE IN EMERGENCIES	9-10
903	FIRE SUPPRESSION	9-11
904	FIRST-AID PROCEDURES FOR CRYOGENIC-INDUCED INJURIES	9-15
905	SAFEGUARDS FOR ENTERING PERMIT-REQUIRED CONFINED SPACES	9-16
CHAPTER 10: REFERENCES		
APPENDIX A: TABLES AND FIGURES		A-1
APPENDIX B: ASSESSMENT EXAMPLES		B-1
APPENDIX C: SCALING LAWS, EXPLOSIONS, BLAST EFFECTS, AND FRAGMENTATION		C-1
APPENDIX D: CODES, STANDARDS, AND NASA DIRECTIVES		D-1
APPENDIX E: RELIEF DEVICES		E-1
APPENDIX F: ABBREVIATIONS AND ACRONYMS		F-1
APPENDIX G: GLOSSARY		G-1
APPENDIX H: INDEX		H-1

LIST OF FIGURES

Figures	Page	
A1.1	Equilibrium Percentage of Para-hydrogen vs. Temperature	A-3
A1.2	Enthalpy of Normal Hydrogen Conversion	A-4
A1.3	Vapor Pressure of Liquefied Para-hydrogen (TP to NBP)	A-5
A1.4	Vapor Pressure of LH ₂ (NBP to CP)	A-6
A1.5	Vapor of Normal and Para-hydrogen Below the Triple Point	A-7
A1.6	Comparison of densities and bulk Fluid Heat Capacities for Slush, Triple-Point liquid, and NBP Liquid Para-hydrogen	A-8
A1.7	Proposed Phase Diagram (P-T) for Solid Hydrogen at Various Otho-hydrogen Mole Fractions	A-9
A1.8	Proposed Phase Diagram (V-T Plane) for Solid Normal Hydrogen	A-10
A1.9	Specific Heat (Heat Capacity) of Saturated Solid Hydrogen	A-11
A1.10	Melting Line from Triple Point to Critical Point Pressure for Para-hydrogen	A-12
A2.1	Flammability Limits at a Pressure of 101.3 kPa (14.7 psia) and a Temperature of 298 K (77 °F)	A-37
A2.2	Effects of N ₂ , He, CO ₂ , and H ₂ O Diluents on Flammability Limits of Hydrogen in Air at 101.3 kPa (14.7 psia)	A-38
A2.3	Effects of Halocarbon Inhibitors on Flammability Limits of Hydrogen-Oxygen Mixtures at a Pressures of 101.3 kPa (14.7 psia) and a Temperature of 298 K (77 °F)	A-39
A2.4	Distance for Fireball Radiation Flux Induced Third Degree Burns per Amount of Fuel Burned at a Thermal Radiation Intensity of 134 kJ/m ² (11.8 Btu/ft ²)	A-40
A2.5	Radiation Intensity as a Function of Exposure Time or Escape Time	A-41

LIST OF FIGURES (continued)

Figures	Page	
A2.6	Variation in Distance from a Hydrogen Fire for a Thermal Radiation Exposure of 2 cal/cm ² for an Exposure Duration of 10 s	A-42
A2.7	Minimum Dimensions of GH ₂ -Air Mixtures for Detonation at 101.3 kPa (14.7 psia) and 298 K (77 °F)	A-43
A2.8	Detonation Cell Widths for Hydrogen-Air Mixtures at 101.3 kPa (14.7 psia)	A-44
A2.9	Minimum Initiation Energies for Direct Detonation of Hydrogen-Air Mixtures	A-45
A4.1	Flame Dip as a Function of Stack Diameter an Hydrogen Flow	A-65
A4.2	Blowout and Stable Flame Region	A-66
A4.3	Flame Shape in Crosswinds	A-67
A4.4	Minimum Flow Rate for Non-Stratified, Two Phase Hydrogen and Nitrogen Flow for Pipeline Fluid Qualities Below 95% and 98%	A-68
A4.5	Liquid Hydrogen Flow Rate Limits to Avoid Excessive Cooldown Stresses in Thick-wall Piping Sections Such as Flanges for 304 SS and 6061 Al	A-69
A4.6	Liquid Nitrogen Flow Rate Limits to Avoid Excessive Cooldown Stresses in Thick-wall Piping Sections Such as Flanges for 304 SS and 6061 Al	A-70
A5.1	Charpy Impact Strength as a Function of Temperature for Various Materials	A-75
A5.2	Yield and Tensile Stress of 5086 Aluminum as a Function of Temperature	A-76
A5.3	Yield and Tensile Stress of AISI 430 Stainless Steel as a Function of Temperature	A-77
A5.4	Thermal Expansion Coefficient of Copper as a Function of Temperature	A-78

LIST OF FIGURES (continued)

Figures		Page
A5.5	Total Linear Thermal Contraction as a Function of Temperature for Several Materials	A-79
A6.1	Irradiance of Common IR Sources	A-93
A6.2	Atmospheric IR Transmission and H ₂ -Air-Flame Emission	A-94
A6.3	UV/VIS/Near-IR Emissions	A-95
A6.4	Flame Components	A-95

LIST OF TABLES

Tables		Page
A1.1	Selected Thermophysical, Chemical, and Combustion Properties of Gaseous, Liquefied, Slush and Solid Para-hydrogen	A-13
A1.2	Fixed Point Properties of Normal Hydrogen	A-17
A1.3	Thermodynamic Properties of the Hydrogen Solid-Vapor Two Phase Region	A-19
A1.4	Thermodynamic Properties of the Hydrogen Solid-Liquid Two Phase Region	A-20
A1.5	Molar Volume of Compressed Solid Para-hydrogen	A-21
A1.6	Thermal Expansion of Solid Para-hydrogen	A-22
A2.1	Potential Ignition Sources	A-46
A2.2	Flammability Limits	A-47
A2.3	Effects of Diluents on Flammable Range for Hydrogen in Air	A-48
A2.4	Inhibitor for Extinction of Hydrogen Diffusion Flames	A-49
A2.5	Critical Radiant Flux Levels	A-50
A3.1	Order of Preference for Location of GH ₂ Storage Systems	A-53
A3.2	Quantity-Distance Requirements for Nonpropellant GH ₂ Systems for Outdoor Locations	A-54
A3.3	Order of Preference for Locations of LH ₂ Storage Systems	A-55
A3.4	Quantity-Distance Requirements for Nonpropellant LH ₂ Systems for Outdoor Locations	A-56
A3.5	Liquid Propellant Hazard and Compatibility Groups	A-57
A3.6	Explosive Equivalent Factors for Liquid Propellants	A-58
A3.7	Safe Quantity-Distance Relationships for LH ₂ Storage for Hazard	

LIST OF TABLES (continued)

Tables		Page
A3.8	Separation and Intraline Quantity-Distance Values for Mixed Propellants	A-61
A4.1	Summary of Liquefied Hydrogen Spill Data	A-71
A5.1	Summary of Material Compatibility for Hydrogen Service	A-80
A5.2	A Selection of Recommended Materials for Typical Applications	A-81
A5.3	Minimum Temperatures and Basic Allowable Stresses in Tension for Selected Metals	A-82
A5.4	Elastic Properties of Selected Materials at Room Temperature and Liquid Hydrogen Temperature	A-84
A5.5	Mechanical Properties of Selected Materials at Room Temperature and Liquid Hydrogen Temperature	A-85
A5.6	Thermal Properties of Selected Materials at Room Temperature and Liquid Hydrogen Temperature	A-86
A5.7	Typical Characteristics of Hydrogen Embrittlement Types	A-87
A5.8	Susceptibility of Materials to Embrittlement in Hydrogen at 10,000 psi and 72 °F	A-88
A5.9	Comparison Effects of Air, Helium, and Hydrogen Exposure on Selected Aluminum, Nickel, and Copper Alloys	A-89
A6.1	Typical Hydrogen Gas Detectors	A-96
A6.2	A Survey and Analysis of Commercially Available Hydrogen Sensors	A-97
A6.3	Sensitivity Limits of Hydrogen Detectors	A-98
A6.4	Typical Hydrogen Fire Detectors	A-99
A7.1	Hydrogen Accidents - Industrial	A-103
A7.2	Hydrogen Accidents - Ammonia Plants	A-104

LIST OF TABLES (continued)

<u>Tables</u>	<u>Page</u>
A7.3 Hydrogen Accidents - Aerospace	A-105
B1 Detonation Pressures and Temperatures	B-2
B2 Deflagration Pressures	B-4
B3 Liquid-Lockup Pressure Change	B-6
B4 Minimum Separation Distances for Siting the LH ₂ Dewar in Example 6	B-20
D1 Selection of Federal Regulations for Hydrogen Transportation	D-17
E1 Considerations for Relief Devices in LH ₂ Pipelines	E-6

CHAPTER 1: BASIC HYDROGEN SAFETY GUIDELINES

Note: Hydrogen shall be stored, handled, and used so life and health are not jeopardized and the risk of property damage is minimized.

100 SCOPE

This handbook is a central agency document containing guidelines for safely storing, handling, and using hydrogen in gaseous, liquid, or slush form, whether used as a nonpropellant or propellant. Each designer, user, operator, maintainer, assurance person, and designated project manager is responsible for incorporating the appropriate requirements of this guideline document into their projects or facilities. However, use of this guideline document does not relieve the designer, user, operator, maintainer, and assurance person and designated managers of professional responsibility or allow them to preclude the exercise of sound engineering judgment.

101 INTRODUCTION

a. General.

- (1) The purpose of the Hydrogen Safety Handbook is to provide a practical set of guidelines for safe hydrogen use. For the purposes of this handbook, hydrogen may refer to the gaseous (GH_2), to the liquefied (LH_2), and/or slush (SLH_2) form. Specific or special considerations for each form will be delineated. This handbook contains chapters on properties and hazards, facility design, design of components, materials compatibility, detection, and transportation. It also covers various operational issues and emergency procedures. The intent of this handbook is to provide enough information that it can be used alone, but at the same time, reference data sources that can provide much more detail if required. Any information contained herein on hazards and use of hydrogen is based on current knowledge and is subject to change as more testing is completed and evaluated.
- (2) Federal and state mandatory regulation shall take precedence over NASA directives in the event of conflicting requirements. A primary policy of NASA is that when requirements conflict, the most stringent shall apply (NSS 1740.11 1993).

101a

101b

b. Nonpropellant Use.

The following standards apply and shall be followed for hydrogen used as a nonpropellant:

- (1) 29 CFR 1910.119 (1996) sets requirements for hazard analysis for systems involving 4535 kg (10,000 lb) or more of hydrogen in any form.
- (2) 29 CFR 1910.103 (1996) sets requirements for GH₂ systems. This regulation does not apply to single GH₂ systems using containers having a total hydrogen content of less than 11 CM (400 CF), measured at 101.3 kPa (14.7 psia) and 294.1 K (70 °F). The regulation shall apply where individual systems, each having a total hydrogen content of less than 11 CM (400 CF), are located less than 1.5 m (5 ft) from each other.
- (3) 29 CFR 1910.103 (1996) sets requirements for LH₂ systems. This regulation does not apply to portable containers having a total LH₂ content of less than 150 L (39.63 gal), nor to a LH₂ system with a content greater than 283,910 L (75,000 gal).
- (4) All pressure vessels for hydrogen service shall be designed, constructed, and tested in accordance with ASME Boiler and Pressure Vessel Code (BPVC) (1995) and NMI 1710.3 (1994), NSS/HP 1740.1 (1974), and NSS 1740.4 (1976). The appropriate standards from these codes shall be used for aerospace pressure vessels. All piping systems for hydrogen service shall be designed, constructed, and tested in accordance with ANSI/ASME B31.1 (1995) and ANSI/ASME B31.3 (1996) as appropriate.

c. Propellant Use.

The following standards and guidelines apply and shall be followed for LH₂ used as a propellant:

- (1) 29 CFR 1910.119 (1996) sets requirements for hazard analysis for systems involving 4535 kg (10,000 lb) or more of hydrogen in any form.

- (2) 29 CFR 1910.103 (1996) sets requirements for LH₂ systems except for the requirements for quantity and distance siting and for personnel monitoring.
- (3) NSS 1740.12 (1993)(DoD 6055.9 1992) sets requirements for siting LH₂ storage in relation to facilities and other propellants and chemical storage and for personnel monitoring.
- (4) All pressure vessels for hydrogen service shall be designed, constructed, and tested in accordance with ASME BPVC (1995) and NMI 1710.3 (1994), NSS/HP 1740.1 (1974), and NSS 1740.4 (1976). The appropriate standards from these codes shall be used for aerospace pressure vessels. All piping systems for hydrogen service shall be designed, constructed, and tested in accordance with ANSI/ASME B31.3 (1996).

d. SLH₂ and Solid Hydrogen.

No standards specifically apply to SLH₂ and solid hydrogen at present. It is suggested that when the total mass of these materials in the system being considered is equivalent to the amounts cited in 101.b(1) and 101.b(3) that these reference standards be applied. Except for supplying limited property data in Appendix A1, solid hydrogen is not discussed further.

e. Minimum Quantities.

The authority having jurisdiction (AHJ) at the controlling NASA center is responsible and shall establish requirements for safe storage and use that shall protect all personnel and facilities, for hydrogen systems in quantities below the minimum quantity specified in the above standards and guidelines.

f. Other Facilities.

Those facilities, equipment, and test articles that do not meet the definitions of GH₂ or LH₂ systems as stated in the standards and guidelines above but are in hydrogen service shall have applied for their design, construction, testing, and use 29 CFR 1910.103 (1996), 29 CFR 1910.119 (1996), NSS 1740.12 (1993), and other standards as directed by the AHJ at the controlling NASA center.

101g

g. Retroactivity.

- (1) An existing system for hydrogen used as a nonpropellant not in strict compliance with the provisions of these standards and guidelines shall be permitted to be continued in use where such use does not constitute a distinct hazard to life or adjoining facilities (NFPA 50A 1994 and NFPA 50B 1994).
- (2) Existing facilities for LH₂ used as a propellant not in compliance with current standards may continue to be used for the balance of their functional lives, as long as current operations present no significantly greater risk than that assumed when the facility was originally designed, and it can be demonstrated clearly that a modification to bring the facility into compliance is not feasible. However, the facility must be brought into compliance with current standards (NSS 1740.12 1993) in the case of a major renovation.

102 APPLICABLE DOCUMENTS

Information on safe use of hydrogen systems is cited in each section. Unless otherwise specified, the latest revision of documentation shall be used. The latest revision applies in the event of conflict. Unit conversions are consistent with ANSI/IEEE Std 268 (1992).

103 PERSONNEL TRAINING

a. Hydrogen Handling Training.

Personnel handling hydrogen or designing equipment for hydrogen systems must become familiar with the physical, chemical, and specific hazardous properties of GH₂, LH₂, and SLH₂. Training should include detailed safety programs that recognize human capabilities and limitations. The goal of the safety program is to eliminate accidents and to minimize the severity of accidents that occur (NHB 1700.1 1993). Appendix B, Example 12 provides a summary of typical information that may be presented in training/certification of liquid hydrogen handlers.

b. Designer Training.

Personnel involved in equipment design and operations planning must be trained to carefully adhere to accepted standards and guidelines and comply with the regulatory codes (NHB 1700.1 1993).

c. Operator Certification.

Operators must be certified for handling GH₂, LH₂, and SLH₂, as appropriate, and in the emergency procedures for spills and leaks. Operators must be kept informed of any changes in safety procedures and facility operations (NHB 1700.1 1993 and 29 CFR 1910.103 1996).

d. Hazard Communication Program.

The AHJ at the controlling NASA center shall develop, implement, and maintain at the workplace a written hazard communications program for their workplaces (29 CFR 1910.1200 1996).

e. Annual Review.

Each NASA installation will annually review all operations being performed at the installation to ensure that the safety training program is working effectively and to identify and enter into the program all potentially hazardous jobs in addition to jobs designated mandatory. Employee safety committees, employee representatives, and other interested groups should be provided an opportunity to assist in the identification process (NHB 1700.1 1993).

104 USE OF INHERENT SAFETY FEATURES

a. Hazards Elimination.

Regardless of quantity, all hydrogen systems and operations must be devoid of hazards by providing adequate ventilation, designing and operating to prevent leakage, and eliminating potential ignition sources.

b. Barriers.

Barriers or safeguards should be provided to minimize risks and control failures.

104b

104c

c. Safety Systems.

Safety systems should be installed to detect and counteract or control the possible effects of such hazards as vessel failures, leaks and spills, embrittlement, collisions during transportation, vaporization system failures, ignitions, fires and explosions, cloud dispersions, and the exposure of personnel to cryogenic or flame temperatures.

d. Safe Interface.

A safe interface must be maintained under normal and emergency conditions so at least two failures occur before hazardous events could lead to personal injury, loss of life, or major equipment or property damage.

105 CONTROLS

a. Warning Systems.

Warning systems should be installed to detect abnormal conditions, measure malfunctions, and indicate incipient failures. Warning system data transmissions with visible and audible signals should have sufficient redundancy to prevent any single-point failure from disabling the system.

b. Flow Controls.

Safety valving and flow regulation should be installed to adequately respond for protection of personnel and equipment during hydrogen storage, handling, and use.

c. Safety Features.

System and equipment safety features should be installed to automatically control the equipment required to reduce the hazards suggested by the triggering of the caution and warning systems. Manual controls within the systems should be constrained by automatic limiting devices to prevent over-ranging.

106 FAIL-SAFE DESIGN

a. Certification.

The equipment, power, and other system services shall be verified for safe performance in the design and normal operational regimes through certification.

b. Fail-Safe Design.

Any failure from which potentially hazardous conditions are a risk shall cause the system to revert to conditions that will be safest for personnel and with the lowest property damage potential.

c. Redundant Safety.

Redundant safety features shall be designed to prevent a hazardous condition when a component fails.

107 SAFETY

a. Safety Review.

All plans, designs, and operations associated with hydrogen use must be subject to an independent, safety review in accordance with NHB 1700.1 (1993). Safety reviews should be conducted on effects of fluid properties, training, escape and rescue, fire detection, and fire fighting.

b. Operating Procedures.

Operating procedures for normal and emergency conditions shall be established and reviewed as appropriate (NHB 1700.1 1993).

c. Hazards Analysis.

Hazards analyses must be performed to identify conditions that may cause injury, death, or property damage.

107c

107d

d. Mishap Reporting.

Reporting, investigating, and documenting the occurrences, causes, and corrective action required for mishaps, incidents, test failures, and mission failures shall follow established basic policy procedures and guidelines (NMI 8621.1 1983 and NHB 1700.1 1993).

108 WAIVER PROVISIONS

Although this is a guideline handbook, it contains required safety provisions noted by shall and must. The actions indicated are required by standards and regulations and are to be followed to prevent loss of life, injury, or property damage. Waivers to required safety provisions shall be handled and reviewed in accordance with local procedures consistent with NHB 1700.1 (1993). NASA variances, deviations, or waivers do not apply to Federal and applicable state and local regulations (NHB 1700.1 1993).

Actions specified by should are recommended guidelines and also denote additional safety considerations.

CHAPTER 2: PROPERTIES AND HAZARDS OF HYDROGEN

Note: Hydrogen is an equilibrium mixture of ortho-hydrogen and para-hydrogen. These molecules have slightly different physical properties but are chemically equivalent; therefore, the hazards associated with the use of hydrogen are the same irrespective of the molecular form.

TYPICAL PROPERTIES

a. Ortho- and Para-Hydrogen.

The hydrogen molecule exists in two forms, distinguished by the relative rotation of the nuclear spin of the individual atoms in the molecule. Molecules with spins in the same direction (parallel) are called ortho-hydrogen; and those with spins in the opposite direction (antiparallel), para-hydrogen. Figure A1.1 shows that the ortho-hydrogen will convert to para-hydrogen as the temperature of hydrogen is lowered. The equilibrium mixture of ortho- and para-hydrogen at any temperature is referred to as equilibrium hydrogen. The equilibrium ortho-para-hydrogen mixture with a content of 75 percent ortho-hydrogen and 25 percent para-hydrogen at room temperature is called normal hydrogen. The ortho-para-hydrogen conversion is accompanied by a release of heat, 703 J/g (302.4 Btu/lb) at 20 K (-423 °F) for ortho- to para-hydrogen conversion, or 527 J/g (226.7 Btu/lb) for normal to para-hydrogen conversion (Figure A1.2). Unless catalyzed, this conversion is slow but occurs at a finite rate (taking several days to complete) and continues even in the solid state. Catalysts are used to accelerate this conversion in LH₂ production facilities, which produce almost pure para-hydrogen liquid (≥95 percent). Be aware of some property differences in these different forms of hydrogen and observe for which form the data are given.

b. Slush Hydrogen.

SLH₂ is a mixture of solid and LH₂ at the triple point temperature. Properties of a 50 percent by mass solid or 50 percent by volume solid mixture usually are given; although, other mass (or volume) fraction mixtures of solid and liquid are possible.

200b

c. Hydrogen Properties.

Selected thermophysical properties of various states of hydrogen, primarily para-hydrogen, are given in the figures and tables in Appendix A1. McCarty, Hord, and Roder (1981) provide an extensive tabulation of the thermophysical properties of hydrogen. Figure A1.3 shows the vapor pressure of liquefied para-hydrogen as a function of temperature from the triple point to the normal boiling point (NBP), and Figure A1.4 shows it from the NBP to the critical point. Figure A1.5 gives the vapor pressure of para-hydrogen and normal hydrogen below the triple point. Figure A1.6 gives the dielectric constant of various states of para-hydrogen. Figure A1.7 gives a comparison of the densities and bulk fluid heat capacities for slush, triple-point liquid, and normal boiling liquid para-hydrogen. Figure A1.8 shows a proposed phase diagram (P-T plane) for solid hydrogen at various ortho mole fractions. Figure A1.9 gives a proposed phase diagram (V-T plane) for solid normal hydrogen. Figure A1.10 shows the specific heat (heat capacity) of saturated solid hydrogen. Figure A1.11 gives the melting line from the triple point to the critical point pressure for para-hydrogen. Table A1.1 gives selected thermophysical, chemical, and combustion properties of para-hydrogen. This table presents property data for gaseous, liquid, slush, and solid phases. Table A1.2 gives some fixed point properties of normal hydrogen. Table A1.3 gives a tabulation of thermodynamic properties of the hydrogen solid-vapor two-phase region, and Table A1.4 gives a tabulation of the thermodynamic properties of the hydrogen solid-liquid two-phase region. Table A1.5 gives some data on the molar volume of compressed solid para-hydrogen. Table A1.6 gives the thermal expansion coefficient of solid para-hydrogen from 1 to 13.8 K (-458 to -435 °F).

d. Health Hazard Properties.

Hydrogen is nontoxic, classified as a simple asphyxiant, and has no threshold limit value (TLV). Hydrogen is not listed as a carcinogen by the National Toxicology Program, International Agency Research on Cancer, or Occupational Safety and Health Administration. Health hazard data are given in a hydrogen Material Safety Data Sheet (MSDS) in Appendix A1, Addendum.

201 TYPES OF HAZARDS

a. General.

The hazards associated with the use of hydrogen can be characterized as physiological (frostbite, respiratory ailment, and asphyxiation), physical (phase changes, component failures, and embrittlement), and chemical (ignition and burning). A combination of hazards occur in most instances. The primary hazard associated with any form of hydrogen is inadvertently producing a flammable or detonable mixture, leading to a fire or detonation. Safety will be improved when the designers and operational personnel are aware of the specific hazards associated with the handling and use of hydrogen. Hazards of hydrogen use are discussed below.

b. Industrial and Aerospace Accidents.

- (1) Industrial and aerospace accidents from the use of hydrogen have occurred. Tables A7.1 through A7.3 list types of accidents. Analyses of these accidents indicate the following factors are of primary importance in causing system failures:
 - (a) Mechanical failure of the containment vessel, piping, or auxiliary components (brittle failure, hydrogen embrittlement, or freeze-up)
 - (b) Reaction of the fluid with a contaminant (such as air in a hydrogen system)
 - (c) Failure of a safety device to operate properly
 - (d) Operational error
- (2) Analyses of accidents have shown that the response, through design or operating procedures, to a failure should be such that a single failure does not lead to a series of failures or a chain reaction of failures; such as, any failure must be restricted to a local event; otherwise, the hazard and potential for damage is greatly enhanced.

201b

201c

c. Ignition.

Fires and explosions have occurred in various components of hydrogen systems as a result of a variety of ignition sources. Ignition sources have included mechanical sparks from rapidly closing valves, electrostatic discharges in ungrounded particulate filters, sparks from electrical equipment, welding and cutting operations, catalyst particles, and lightning strikes near the vent stack. Table A2.1 lists additional ignition sources.

d. Fire and Explosions.

A potential fire hazard always exists when hydrogen is present.

- (1) GH₂ diffuses rapidly with air turbulence increasing the rate of GH₂ dispersion. Evaporation can rapidly occur in an LH₂ spill; resulting in a flammable mixture forming over a considerable distance. Although ignition sources may not be present at the leak or spill location, fire could occur if the movement of the flammable mixture causes it to reach an ignition source.

Example: Observation alone is not a reliable technique for detecting pure hydrogen-air fires or assessing their severity. A fire resulted from an accident in which a small leak developed. The equipment was shutdown and the flame appeared to diminish; however, molten metal drippings from the equipment indicated a more severe fire was in progress.

- (2) A deflagration could result if a mixture within flammability limits is ignited at a single point.
- (3) A detonation could occur if the GH₂-air mixture is within detonability limits and an appropriate energy source is available. A deflagration could transform into a detonation if there is confinement or a mechanism for flame acceleration.
- (4) Flash fires or boiling liquid expanding vapor explosions (BLEVE) could occur when an external source of thermal energy is heating LH₂ or SLH₂ and there is a path to the surroundings.

e. Leaks.

Leaks can occur within a system or to the surroundings. Hazards can arise by air or contaminants leaking into a cold hydrogen system (LH₂ or SLH₂), such as by cryo-pumping. Leaks are usually caused by deformed seals or gaskets, valve misalignment, or failures of flanges or equipment. A leak may cause further failures of construction materials. For leaks involving LH₂, vaporization of cold vapor hydrogen to the atmosphere may provide a warning because moisture condenses and forms a fog. Undetected hydrogen leaks can lead to fires and explosions.

Example: Hydrogen leaks generally originate from valves, flanges, diaphragms, gaskets, and various types of seals and fittings. The leaks usually are undetected because of the absence of a continuous hydrogen monitor in the area. An example of this condition was a large sphere partitioned by a neoprene diaphragm with hydrogen stored under the diaphragm and air above it. An explosion-proof fan was placed on top of the sphere to provide a slight positive pressure on the diaphragm. A violent explosion occurred in the sphere after the plant was shutdown. Hydrogen leaked past the diaphragm when the fan was turned off. Ignition was attributed to an electrostatic discharge cause by motion of the diaphragm or a source associated with the explosion-proof fan. The explosion could have been avoided by using an inert gas instead of air across the diaphragm or monitoring the hydrogen concentration in the upper hemisphere.

f. Hydrogen Dispersion.

A property of hydrogen that tends to limit the horizontal spread of combustible mixtures from a hydrogen spill is its buoyancy. Although saturated hydrogen is heavier than air at the temperatures existing after evaporation from a spill, it quickly becomes lighter than air, making the cloud positively buoyant. The dispersion of the cloud is affected by wind speed and wind direction and can be influenced by atmospheric turbulence and nearby structures. Although condensing moisture is an indication of cold hydrogen, the fog shape does not give an accurate description of the hydrogen cloud location (Witcofsky and Chirivella 1982). The use of dikes or barricades

201f

around hydrogen storage facilities should be carefully examined because it is preferred to disperse any leaked or spilled LH₂ or SLH₂ as rapidly as possible. Dikes or berms generally should not be used unless their purpose is to limit or contain the spread of a liquid spill because of nearby buildings, ignition sources, etc. However, such confinement may delay the dispersion of any spilled liquid by limiting the evaporation rate, and could effect a combustion event that might occur.

g. Storage Vessel Failure.

The release of GH₂ or LH₂ may result in ignition and combustion, causing fires and explosions. Damage may extend over considerably wider areas than the storage locations because of hydrogen cloud movement. Vessel failure may be started by material failure, excessive pressure caused by heat leak, or failure of the pressure-relief system.

h. Vent and Exhaust System.

Vent and exhaust system accidents are attributed to inadequate ventilation and the inadvertent entry of air into the vent. Backflow of air can be prevented with suitable vent stack designs, provision of makeup air (or adequate supply of inert gas as the situation demands), check valves, or molecular seals.

i. Purging.

Pipes and vessels should be purged with an inert gas before and after using hydrogen in the equipment. Nitrogen may be used if the temperature of the system is above 80 K (-316 °F), whereas, helium should be used if the temperature is below 80 K (-316 °F). Alternatively, a GH₂ purge may be used to warm the system to 80 K (-316 °F) and then switch to a nitrogen purge if the system is below 80 K (-316 °F); however, some condensation of the GH₂ may occur if the system contains LH₂. Residual pockets of hydrogen or the purge gas will remain in the enclosure if the purging rate, duration, or extent of mixing is too low. Tables A7.1 through A7.3 list 12 fire or explosion incidents that resulted from such situations, demonstrating the difficulties in purging hydrogen from large systems. Uniform mixing and dilution is unlikely in partially enclosed spaces. Reliable gas concentration measurements should be obtained at a number of different locations within the system for suitable purges.

Example: A dangerous purging practice that led to an explosion occurred when only a portion of a hydrogen system was isolated to reduce the purge time and volume. Complete isolation usually cannot be ensured because of the propensity of hydrogen to leak.

j Vaporization System Failure.

Pipe valving in vaporization systems may fail, causing injury from low-temperature exposures. Ignition of the hydrogen may occur, resulting in damage from fires and explosions.

k. Condensation of Air.

An uninsulated line containing LH₂ or cold hydrogen gas, such as a vent line, can be sufficiently cold (less than 90 K (-298 °F) at 101.3 kPa (14.7 psia)) to condense air on the outside of the pipe. The condensed air, which can be enriched in oxygen to about 50 percent, must not be allowed to contact sensitive material or equipment. Materials not suitable for low temperatures, such as carbon steel, can become embrittled and fail. Moving parts and electronic equipment can be adversely affected. Condensed air must not be permitted to drip onto combustible materials such as tar and asphalt (an explosive mixture can be created).

l. Hydrogen Embrittlement.

Containment systems may fail and the subsequent spills and leaks will create hazards when the mechanical properties of metallic and nonmetallic materials degrade from hydrogen embrittlement. Hydrogen embrittlement is a long term effect and occurs from continued use of a hydrogen system.

Example: Tables A7.1 through A7.3 list piping and vessel ruptures caused by materials problems including hydrogen embrittlement, stress corrosion, and weld failures. Most of the damage was incurred by ignition of the hydrogen following the rupture. All repairs and modifications to piping and equipment that handles hydrogen must be carefully engineered and tested.

201m

m. Physiological Hazards.

Personnel present during leaks, fires, or explosions of hydrogen systems can incur several types of injury.

- (1) Asphyxiation is a hazard when someone enters a region where hydrogen or a purge gas has displaced the air, diluting the oxygen below 19.5 percent by volume. Stages of asphyxiation (at ground level) have been noted based on the oxygen concentration:

15-19 percent by volume	Decreased ability to perform tasks; may induce early symptoms in persons with heart, lung, or circulatory problems
12-15 percent by volume	Deeper respiration, faster pulse, poor coordination
10-12 percent by volume	Giddiness, poor judgment, slightly blue lips
8-10 percent by volume	Nausea, vomiting, unconsciousness, ashen face, fainting, mental failure
6-8 percent by volume	Death in 8 min; 50 percent death and 50 percent recovery with treatment in 6 min, 100 percent recovery with treatment in 4 to 5 min
4 percent by volume	Coma in 40 s, convulsions, respiration ceases, death

- (2) Blast waves from explosions will cause injury as a result of overpressure at a given location or a combination of overpressure and duration at a given location as follows (DoD 6055.9 1992):

3 psi overpressure	1 percent eardrum rupture
--------------------	---------------------------

16 psi overpressure	50 percent eardrum rupture
10 psi overpressure for 50 ms or 20-30 psi overpressure for 3 ms	Threshold of lung rupture
27 psi overpressure for 50 ms or 60-70 psi overpressure for 3 ms	1 percent mortality

- (3) The radiant heat that reaches and is absorbed by a person from a GH₂-air flame is directly proportional to a variety of factors including exposure time, burning rate, heat of combustion, size of the burning surface, and atmospheric conditions (especially water vapor). Thermal radiation flux exposure levels show the following:

Flux of 0.47 W/cm ² (1490 Btu/min·ft ²)	Pain felt in 15-30 s Skin burns in 30 s
--	--

Flux of 0.95 W/cm ² (2722 Btu/min·ft ²)	Immediate skin reactions
--	--------------------------

Figure A2.4 shows the distance-fuel weight relationship for third degree burns for thermal radiation of 134 J/m² (11.8 Btu/ft²). Figure A2.5 shows heat radiant intensity versus exposure time for threshold pain values. Figure A2.6 shows the effect of water vapor on radiant energy from a hydrogen fire.

- (4) Cryogenic burns result from contact with cold fluids or cold vessel surfaces.
- (5) Exposure to large LH₂ spills could result in hypothermia if proper precautions are not taken.

n. Collisions During Transportation.

Damage to hydrogen transportation systems (road, rail, air, and water) can cause spills and leaks that may result in fires and explosions.

201n

Example: Most of the incidents during transportation occurred outside of industrial facilities. Seventy-one percent of the hydrogen releases did not lead to an ignition. The relatively few ignitions may be due to a lack of ignition sources or the rapid dispersal of hydrogen into the atmosphere. In any event, the accident data provide further incentive to transport, transfer, and store hydrogen outdoors, away from occupied areas.

202 FLAMMABILITY AND IGNITION OF HYDROGEN

Note: Major emphasis should be on containment, detection, and ventilation because the minimum energy of GH_2 ignition in air at atmospheric pressure is about 0.02 mJ (1.9×10^{-8} Btu) and experience shows that escaped hydrogen is very easily ignited.

It is necessary for hydrogen to be mixed with an oxidant, the mixture be within flammability limits, and an appropriate ignition source be present for hydrogen to burn. Leaks and accumulations occur even with the best efforts to contain hydrogen. The safe procedure is to eliminate all likely sources of ignition or place them away from areas of possible hydrogen leakage. Fifty-three percent of the industrial accidents listed in Table A7.1 occurred because of leaks, off-gassing, and equipment ruptures. Fifteen percent were purging or vent-exhaust incidents, and the remaining 32 percent were other types of incidents. The vast majority of the accidents in ammonia plants listed in Table A7.2 occurred because of gaskets and valve packing leaking. Eighty-seven out of 107 aerospace hydrogen incidents listed in Table A7.3 involved release of GH_2 or LH_2 . When accidents were not caused by equipment failure, they primarily occurred when procedures were not prescribed or when prescribed procedures were not followed (Ordin 1974). Accident reports showed that electrical short circuits and sparks were considered to be responsible for 25 percent of the ignitions, and static charges were responsible for about 18 percent of the ignitions. Welding or cutting torches, metal fracture, gas impingement, and the rupture of safety disks were each considered responsible for 3 to 6 percent of the ignitions.

a. Flammability.

- (1) Mixtures of hydrogen with air, oxygen, or other oxidizers are highly flammable over a wide range of compositions. The flammability limits, in percent by volume of hydrogen, define the range over which fuel vapors will ignite when exposed to an ignition source of sufficient energy. Flammability limits

are dependent on the ignition energy, temperature, pressure, presence of diluents, and size and configuration of the equipment, facility, or apparatus.

- (2) A flammable mixture may be diluted with either of its constituents until the mixture concentration falls outside the flammability limits: below the lower flammability limit (LFL) or above the upper flammability limit (UFL). The flammability range for hydrogen-air and hydrogen-oxygen mixtures is broadest for upward flame propagation and narrows for downward flame propagation.
- (3) Neither LH₂ or SLH₂ as fuel, and liquid oxygen (LOX) or solid oxygen as oxidizer, are hypergolic. Mixtures of these materials have ignited during the mixing process because the energy required to ignite them is so small (Bunker, Dees, and Eck 1995). LH₂ and liquid-solid oxygen have been detonated by an externally generated shock wave. Comparable experimental examination of SLH₂ systems does not exist.
- (4) The flammability limits of hydrogen in dry air at 101.3 kPa (14.7 psia) and ambient temperature are 4.1 percent (LFL) to 74.8 percent (UFL). These limits apply for upward propagation in tubes. The flammability limits of hydrogen in oxygen at 101.3 kPa (14.7 psia) and ambient temperature are 4.1 percent (LFL) to 94 percent (UFL). These limits apply for upward propagation in tubes. Table A2.2 lists the effect of propagation direction. A reduction in pressure below 101.3 kPa (14.7 psia) tends to narrow the range of flammability by raising the lower limit and lowering the upper limit (Table A2.2).

(a) Hydrogen-Air Mixture.

- 1 The LFL for hydrogen-air mixtures rises to about 9 percent by volume hydrogen above 10.3 MPa (1500 psia), and the UFL rises to about 75 percent by volume above 8.3 MPa (1200 psia). Data indicate that the lowest pressure for which a low-energy ignition source produces ignition is approximately 6.9 kPa (1 psia), at a hydrogen concentration of between 20 and 30 percent by volume (Hertzberg and Litton 1981).

202a

- 2 Various hydrogen-air mixtures were subjected to a 45 mJ (4.27×10^{-5} Btu) spark ignition source in a 311 K (100 °F) temperature environment (Mills, Linley, and Pippen. 1977 and Benz and Boucher 1981). The tests indicate that the LFL was 4.5 percent by volume over the pressure range 34.5 to 101.3 kPa (5 to 14.7 psia). An increasingly richer hydrogen mixture was required to obtain combustion below 34.5 kPa (5 psia). The lowest pressure for which a low-energy ignition source produced ignition was 6.2 kPa (0.9 psia) at a GH_2 -air mixture of between 20 percent and 30 percent by volume GH_2 (Thompson and Enloe 1966).
- 3 Using a strong ignition source, the lowest pressure for which ignition occurs is 0.117 kPa (0.02 psia).
- 4 Raising the temperature from 290 to 673 K (62 to 752 °F) decreases the LFL of hydrogen-air (downward propagation) from 9.0 to 6.3 percent by volume hydrogen and increases the UFL from 75 percent to 81.5 percent by volume hydrogen. Data are for a pressure of 101.3 kPa (14.7 psia).

(b) Hydrogen-Oxygen Mixtures.

- 1 The flammability range for hydrogen-oxygen mixtures of 101.3 kPa (14.7 psia) is from 4 to 94 percent by volume hydrogen for upward propagation in tubes. Reduced pressures increase the LFL (Benz and Boucher 1981). The lowest pressure observed for ignition is 57 Pa (0.008 psia) at a hydrogen concentration of 50 percent by volume when a high-energy ignition source was used.
- 2 Results of tests at elevated pressures indicate the LFL does not change with pressure to 12.4 MPa (1793 psia). A UFL of 95.7 percent by volume hydrogen at 1.52 MPa (220.6 psia)

is reported (Benz, Bishop, and Pedley 1988). Raising the temperature from 288 to 573 K (59 to 572 °F) decreases the LFL from 9.6 to 9.1 percent by volume hydrogen and increases the UFL from 90 to 94 percent by volume hydrogen.

(c) Effects of Diluents.

1 Figure A2.1 shows the flammability limits for hydrogen-oxygen-nitrogen. Table A2.2 shows flammability limits for GH₂ and gaseous oxygen (GOX) with equal concentrations of added inert gases (helium (He), carbon dioxide (CO₂), and nitrogen (N₂)). Table A2.3 shows the qualitative effect of He, CO₂, N₂, and Argon diluents for various tube sizes. Argon was the least effective in reducing the flammable range for hydrogen in air.

2 Figure A2.2 shows the effects of He, CO₂, N₂, and water vapor on the flammability limits of hydrogen in air. Measurements were performed at 298 K (77 °F) and 101.3 kPa (14.7 psia) except for the water vapor studies, which were performed at 422 K (300 °F). Water was the most effective in reducing the flammability range, and helium was the least effective.

(d) Effects of Halocarbon Inhibitors.

1 Figure A2.3 shows the effects of halocarbon inhibitors on the flammability limits of hydrogen-oxygen mixtures.

2 Table A2.4 compares the effect of N₂, CH₃Br, and CBrF₃ required to extinguish hydrogen diffusion flames in air. The inhibitors were more effective when added to the air stream; nitrogen was more effective when added to the fuel stream.

- (5) Autoignition Temperature. Hydrogen is only slightly more difficult to ignite in air than in oxygen. Ignition temperatures are dependent on GH_2 concentration and pressure and the surface treatment of containers. The reported temperature is very dependent on the system and values selected should be applied only to similar systems. At 101.3 kPa (14.7 psia) the range of reported autoignition temperatures for stoichiometric hydrogen in air is 773 to 850 K (932 to 1070 °F); in stoichiometric oxygen it is 773 to 833 K (932 to 1039 °F). At pressures from 20 to 50 kPa (2.9 to 7.25 psia) GH_2 -air ignitions have occurred at 620 K (657 °F).
- (6) Minimum Spark Energy for Ignition. Minimum spark energy for ignition is defined as the minimum spark energy required to ignite the most easily ignitable concentration of fuel in air and oxygen. The minimum spark energies of hydrogen in air are 0.017 mJ (1.6×10^{-8} Btu) at 101.3 kPa (14.7 psia), 0.09 mJ (8.5×10^{-8} Btu) at 5.1 kPa (0.735 psia), and 0.56 mJ (5.31×10^{-7} Btu) at 2.03 kPa (0.294 psia). The minimum spark energy required for ignition of hydrogen in air is considerably less than that for methane (0.29 mJ) or gasoline (0.24 mJ); however, the ignition energy for all three fuels is sufficiently low that ignition is relatively certain in the presence of any weak ignition source; such as, sparks, matches, hot surfaces, or open flames. Even a weak spark caused by the discharge of static electricity from a human body may be sufficient to ignite any of these fuels in air.
- (7) Quenching Gap in Normal Temperature and Pressure Air.
 - (a) The quenching gap for hydrogen in normal temperature and pressure (NTP) air is 0.6 mm (0.024 in.). This value depends on the temperature, pressure, and composition of the combustible gas mixture and the electrode configuration.
 - (b) Faster burning gases generally have smaller quenching gaps, and flame arresters for faster burning gases require smaller apertures. The lowest reported quenching distance for hydrogen is 0.076 mm (0.003 in.) (Wionsky 1972). There are three major considerations in determining the quenching distance

for a gaseous fuel such as hydrogen: ignition energy, mixture ratio, and pressure.

- 1 Quenching gap is a function of ignition energy. Low ignition energy, 0.001 mJ (9.5×10^{-10} Btu), corresponds to a small gap, 0.01 cm (0.0039 in.). Likewise, high ignition energy, 10 mJ (9.5×10^{-6} Btu), requires a larger gap, 1 cm (0.39 in.). (Van Dolah, et al. 1963).
- 2 Pressure and composition affect the quenching distance. The quenching distance increases dramatically at very low pressures. At a distance of several inches, the pressure is barely sufficient to support combustion. The effect of mixture ratios is less well known; however, it appears to be constant for a given pressure between the UFL and LFL (Van Dolah, et al. 1963).
- 3 Specific values for hydrogen-air mixtures are not available; however, the effect of pressure as a function of tube diameter for deflagration and detonation of acetylene-air mixtures can be used as a guideline (Zebetakis and Burgess 1961).

b. Ignition Sources.

There shall be no sources of ignition, such as from open flames, electrical equipment, or heating equipment in buildings or special rooms containing hydrogen systems (29 CFR 1910.103 1996, NFPA 50A 1994 and NFPA 50B 1994).

Note: Ignition sources must be eliminated or safely isolated and operations should be conducted as if unforeseen ignition sources could occur.

202b

202b

- (1) The ignition of GH_2 -air mixtures usually results in ordinary deflagration. Table A2.1 gives potential ignition sources for hydrogen systems. The potential hazards are significantly less than if detonation results. It is possible that in a confined or partially confined enclosure a deflagration can evolve into a detonation. The geometry and flow conditions (turbulence) have a strong effect on the transition from deflagration to detonation.
- (2) Electrical sparks are caused by sudden electrical discharges between objects having different electrical potentials, such as breaking electrical circuits or discharges of static electricity. The sparks may dissipate tremendous amounts of energy in comparison with friction sparks.
- (3) Static electricity can generate sparks that will ignite hydrogen-air or hydrogen-oxygen mixtures. Static electricity is caused by many common articles, such as hair or fur when combed or stroked or a leather belt operating on a machine. People generate high-voltage charges of static electricity on themselves, especially when walking on synthetic carpet or dry ground, wearing nylon or other synthetic clothing, sliding on automobile seats, or combing their hair. Flowing GH_2 or LH_2 can generate charges of static electricity. This is true also for all nonconductive liquids or gases. Flow in SLH_2 has the potential for generating static electricity, although such an effect has not been confirmed. Turbulence in containers as well as laminar flow in systems has the same effect. Static charges may be induced during electrical storms (Beach 1964 and Beach 1965).
- (4) Friction sparks are caused by hard objects coming into shearing contact with each other, such as metal striking metal, metal striking stone, or stone striking stone. Friction sparks are particles of burning material that have been sheared off as a result of contact. The particle initially is heated by the mechanical energy of friction and impact. Sparks struck by hand tools are considered to have low total energy. Mechanical tools

such as drills and pneumatic chisels can generate high-energy sparks.

- (5) Impact sparks are also caused by hard objects coming into forcible contact with each other. Impact sparks are produced by impact on a quartzitic rock such as the sand in concrete. As with friction sparks, small particles of the impacted material are thrown off.
- (6) Hot Objects and Flames.
 - (a) Objects at temperatures from 773 to 854 K (932 to 1078 °F) can ignite hydrogen-air or hydrogen-oxygen mixtures at atmospheric pressure. Substantially cooler objects, about 590 K (602 °F), can cause ignition under prolonged contact at less than atmospheric pressure.
 - (b) Open flames easily ignite hydrogen-air mixtures.
- (7) Provisions should be made to acceptably contain any resulting deflagration or detonation if ignition sources are a required part of a hydrogen use. As an example, a combustor or engine should not be operated in hydrogen-rich atmospheres without well-dispersed water sprays in its exhaust. Experience indicates that multiple bank sprays will partially suppress the detonation pressures and reduce the number and temperature of ignition sources in an exhaust system. Water sprays should not be relied on as a means of avoiding detonations. Carbon dioxide may be used with the water spray to further reduce hazards.

203 DETONATION

The worst-case event resulting from release of all forms of hydrogen into the ambient environment is mixing of the hydrogen with an oxidizer (usually air), reaching detonable concentrations, and subsequent ignition producing a detonation of the mixture. The

positive buoyancy and rapid molecular diffusion of GH_2 means that any release will quickly mix with the surrounding gases. Rapid vaporization occurs and subsequent mixing with the surrounding gases can lead to a detonable mixture if LH_2 or SLH_2 leaks. Should a detonation occur, the resulting reaction zone is a shock wave and the accompanying blast wave has much greater potential for causing personnel injury or equipment damage.

a. Detonation Limits.

Lower and upper detonation limits vary considerably with the nature and dimensions of the confinement and cannot be specified for any fuel-oxidizer mixture unless the nature and dimensions of the confinement are also specified (Benz, Bishop, and Pedley 1988).

- (1) Figure A2.7 shows the minimum dimensions of hydrogen-air mixtures for detonation in three types of confinement at 101.3 kPa (14.7 psia). The figure shows a significant effect of confinement type on detonation limits. The ignition energy for detonation also becomes large for lean or rich mixtures; however, it is possible to produce overdriven detonations when large ignition energy is introduced. Therefore, detonation limits found in the literature should be used with caution. Stable detonations are fairly well characterized by the Chapman-Jouget calculation. Table B1 gives the type of information obtained from such calculations for hydrogen-air. This table was produced using the Gordon-McBride computer code (Gordon and McBride 1994).
- (2) While values of lower and upper detonation limits for GH_2 -GOX of 15 and 90 percent hydrogen (Lewis and von Elbe 1961), respectively, are cited, the values suffer from the same shortcomings noted for hydrogen-air and should be used with caution.
- (3) No specific detonation limits for LH_2 and air or GOX are available. The rapid volatilization of LH_2 to GH_2 and subsequent mixing with air or GOX would result in detonable mixtures as described above.

- (4) Mixtures of solid oxygen in excess (with respect to stoichiometry) and LH₂ is shock sensitive. A stimulus (shock) of 100 to 250 MPa (19,500 to 36,000 psia) will detonate such mixtures. For comparison, nitroglycerin is detonated by 250 to 500 MPa (36,000 to 73,000 psia) shocks (Perlee, Litchfield, and Zabetakis 1964).

b. Detonation Cell Size.

A detonation wave is not a single planar wave front but has a three-dimensional structure consisting of cells. The size of the cell, as measured through the pattern left by a detonation on a smoked plate, is of considerable value in predicting the onset of detonation and describing the conditions for stable detonation waves. The cell size has been shown to relate to several key parameters in assessing a potential hazard, including critical energies and dimensional characteristics of structural confinement of the detonation (Lee, et. al. 1982). The length (a) of a detonation cell is one to two times its width (b). The aspect ratio (a/b) increases with decreasing initial pressure. Detonation cell lengths for stoichiometric GH₂-air/GOX at 101.3 kPa (14.7 psia) are 15.9 mm (0.626 in.) and 0.6 mm (0.024 in.), respectively (Bull, Ellsworth, and Shiff 1982). The measurements are specific to the system configuration used. Figure A2.8 gives the variation of detonation cell widths for GH₂-air mixtures at 101.3 kPa (14.7 psia). Ignition energy requirements depend on the concentration of the detonable mixture. Figure A2.9 gives the grams of tetryl required to detonate the GH₂-air mixtures shown in Figure A2.8.

c. Effect of Temperature, Pressure, and Diluents.

The effect of temperature on detonation cell size for GH₂-air mixtures gives mixed results. The original source should be consulted when citing such effects. Bull, Ellsworth, and Shiff (1982) showed decreasing cell size with increasing pressure for GH₂-air. Increasing concentrations of diluents (percent by volume CO₂, H₂O) significantly increases cell widths of GH₂-air detonations (Shepard and Roller 1982).

d. Energy of Explosion.

The explosive yields for hydrogen-air follow:

NTP GH₂-air

approximately 24 g TNT/g GH₂ (24 lb TNT/lb GH₂)

2.02 kg TNT/m³ GH₂ (0.126 lb TNT/ft³ GH₂)

0.17 g TNT/kJ GH₂ (4x10⁻⁴ lb TNT/Btu GH₂)

NBP LH₂-air

1.71 g TNT/cm³ LH₂ (107.3 lb TNT/ft³ LH₂)

It should be emphasized that only a fraction of this theoretical explosive yield will be realized in an actual open air mishap. It is virtually impossible to spill or release a large quantity of fuel and have all of it mix in proper proportions with air before ignition. Appendix B, Example 1, gives an example of the calculation of the detonation characteristics of hydrogen-air-oxygen mixtures using the Gordon-McBride computer code (Gordon and McBride 1994). TNT produces a short duration, high impulse pressure wave, whereas, a hydrogen-air explosion would have a longer duration and lower impulse pressure wave; the external effects of the two can be quite different.

e. Deflagration-to-Detonation Transition.

A hydrogen-air combustion can start as a detonation, or it can start as a deflagration and then transit to a detonation after the flame has traveled for some distance. The composition range in which a detonation can take place is narrower than that for deflagration. The commonly quoted range for detonation in a hydrogen-air mixture is from 18.3 to 59 percent hydrogen. However, with higher energy ignition sources, the limits can be extended. The factors that influence whether hydrogen-air combustion will occur as a detonation, rather than a deflagration, include the hydrogen percentage, the strength of the initiator, complete or partial confinement of the reaction, and the presence of structures that can induce turbulence in the flame front. An energetic source of initiation is required for combustion to start as a detonation. A mechanism to

accelerate the flame velocity is necessary for a deflagration to transit to detonation. Factors that favor this transition include the composition being within the detonation range, a degree of confinement, and anything that can induce turbulence in the flame front as it travels through the combustible mixture. The latter tends to stretch out the flame front and increase its velocity (Lee 1977).

204 CHARACTERISTIC PROPERTIES OF GH_2

While knowledge of the general chemical and physical properties of hydrogen must be available to the designer and operators of hydrogen systems, some characteristic properties of GH_2 are of particular concern for hazard analyses. The characteristics and properties of particular concern are discussed in this section.

a. Detection.

Hydrogen gas is colorless, odorless, and not detectable in any concentration by human senses. Hydrogen is not toxic but can result in asphyxiation by diluting the oxygen required in breathing air. An atmosphere containing oxygen at a concentration of less than 19.5 percent by volume is considered oxygen deficient (NHS/IH 1845.2 1983).

b. Variable Density.

Hydrogen gas is lighter than NTP air and tends to rise at temperatures above 23 K (-418.6 °F). Saturated vapor is heavier than air and will remain close to the ground until the temperature rises. Buoyant velocities are related to the difference in air and fuel densities; therefore, the cold, dense fuel gases produced by LH_2 spills will rise more slowly than standard temperature and pressure fuel gases. The buoyant velocity of hydrogen in NTP air is 1.2 to 9 m/s (3.94 to 29.5 ft/s).

204c

c. Lack of Flame Color.

A hydrogen-air-oxygen flame is colorless. Any visibility is caused by impurities. At reduced pressures a pale blue or purple flame may be present. Severe burns have been inflicted on persons exposed to hydrogen flames resulting from the ignition of hydrogen gas escaping from leaks.

d. Flame Temperature in Air.

The flame temperature for 19.6 percent by volume hydrogen in air is 2321 K (3718 °F). Table B2 gives the calculated characteristics of several mixtures of hydrogen-air-oxygen using the Gordon-McBride code (Gordon and McBride 1994).

e. Burning Velocity in NTP Air.

The burning velocity in NTP air, defined as the subsonic velocity at which a flame propagates through a flammable fuel-air mixture, is 2.70 to 3.50 m/s (8.86 to 11.48 ft/s). The burning velocities are affected by pressure, temperature, and mixture composition. The high burning velocity of hydrogen indicates its high explosive potential and the difficulty of confining or arresting hydrogen flames and explosions.

f. Thermal Energy Radiated from Flame to Surroundings.

- (1) Exposure to hydrogen fires can result in significant damage from thermal radiation. Thermal radiation is affected by the amount of water vapor in the atmosphere.
- (2) Atmospheric moisture absorbs thermal energy radiated from a fire and can reduce the values. This effect is significant for hydrogen fires. The intensity of radiation from a hydrogen flame at a specific distance depends heavily on the amount of water vapor present in the atmosphere and is expressed as:

$$I = I_0 e^{-0.0046wr} \quad (\text{Eq 1})$$

where:

I_0 = initial intensity (energy/time·area)

w = water vapor (percent by weight)

r = distance (meters)

Figure A2.6 shows additional data on the effect of water vapor on radiant energy from hydrogen fires.

(3) Table A2.5 includes effects of thermal radiation exposure on several materials.

g. Diffusion Coefficient in NTP Air.

The diffusion coefficient for hydrogen in NTP air is 0.61 cm²/s (6.6x10⁻⁴ ft²/s).

h. Limiting Oxygen Index.

The limiting oxygen index is the minimum concentration of oxygen that will support flame propagation in a mixture of fuel, air, and nitrogen. For example, no mixture of hydrogen, air, and nitrogen at NTP conditions will propagate flame if the mixture contains less than 5 percent by volume oxygen.

i. Joule-Thomson Expansion.

Most gases at ambient temperatures cool when expanded across a porous plug; however, the temperature of hydrogen increases when the gas is expanded at a temperature above its inverse Joule-Thomson temperature 193 K (-112 °F). However, the inverse Joule-Thomson effect will not be the primary cause of any combustion that occurs when hydrogen is vented from a high-pressure source. The temperature increase from this effect is only a few degrees Kelvin at the most; it would not raise the gas to its ignition temperature unless the gas was already near the ignition temperature.

205 CHARACTERISTIC PROPERTIES OF LH₂

All of the hazards that exist with GH₂ also exist with LH₂ because of the ease with which the liquid evaporates. Characteristic properties of LH₂ also of particular concern for hazard analyses are discussed in this section.

a. Low Boiling Point.

LH₂ has an NBP of 20.3 K (-423.5 °F) at sea level pressure. Any LH₂ splashed on the skin or in the eyes can cause serious burns by frostbite or hypothermia. Inhaling vapor or cold gas produces respiratory discomfort and asphyxiation can result.

b. Ice Formation.

Vents and valving from storage vessels and dewars may be blocked by accumulations of ice formed from moisture in the air. Excessive pressure may then rupture the container and release hydrogen.

c. Continuous Evaporation.

The continuous evaporation of LH₂ in a vessel generates GH₂, which must be vented to a safe location or temporarily confined safely. Storage vessels and other containers should be kept under positive pressure to prevent air from entering. LH₂ is subject to contamination with air condensed and solidified from the atmosphere or with trace air accumulated during LH₂ production. The quantity of oxygen can buildup during repeated refilling or pressurization of permanent LH₂ storage vessels. This mixture is easily ignited and can then detonate.

d. Pressure Rise.

LH₂ will eventually warm to the surroundings giving a significant pressure rise if it is confined, as in a pipe between two valves. Considering GH₂ as an ideal gas, the pressure resulting from a trapped volume of LH₂ vaporizing and being heated to 294 K (70 °F) is 85.8 MPa (12452 psia). However, the pressure is 172 MPa (25,000 psia) when hydrogen compressibility is considered. A significant pressure increase

will occur in a system with only one phase present and the LH₂ experiences a temperature increase. Appendix B, Example 3 is a sample calculation for such a system.

e. High Density.

The higher density of the saturated vapor may cause the hydrogen cloud to flow horizontally or downward immediately upon release if an LH₂ leak occurs.

f. Electric Charge Build Up.

Willis (1966) measured the electrical conductivity of LH₂ and found typical resistivities to be about 10^{19} Ω·cm at 25 V and that the resistivity was a linear function of applied voltage. As Willis (1966) points out, this indicates that it is not strictly correct to consider the electrical conductivity of LH₂ in terms of Ohm's Law. Although a current can be passed through LH₂, this current can be explained in terms of charge carriers formed by background radiation. Thus, the current carrying capacity is small and more or less independent of the imposed voltage. Investigation has shown that electric charge build up in flowing LH₂ is not a great concern.

206 CHARACTERISTIC PROPERTIES OF SLH₂

All the hazards that exist with GH₂ and LH₂ also exist with SLH₂. Additional system components are required to handle the two-phase SLH₂; therefore, transfer and storage operations become more complex. Characteristic properties of SLH₂ also of particular concern for hazard analyses are discussed in this section.

a. Vapor Pressure.

The vapor pressure of SLH₂ is 7.04 kPa (1 psia). Therefore, the SLH₂ system is designed structurally to operate at pressures below atmospheric and greater care must be taken during operations to prevent air leakage into the system.

206b

b. Volume Change.

Heat leakage into SLH₂ without ullage present requires the continual addition of high solids fraction SLH₂ and the removal of LH₂ because SLH₂ expands as it degrades. Significant increases in volume can occur when the solid phase of SLH₂ melts (see Appendix B, Example 3).

c. Thermal Stratification.

Thermal stratification of SLH₂ storage can occur by design, a layer of LH₂ on top of the SLH₂ rising in temperature to 20.27 K (-423.5 °F) and an equilibrium pressure of 101.3 kPa (14.7 psia), or by operation, such as the introduction of helium into the ullage space for pressure control. Upsetting of the thermal stratification can lead to hazardous pressure changes in both cases.

d. Thermal Acoustic Oscillations.

Thermal acoustic oscillations can lead to pressure surges in SLH₂ systems. Egress of SLH₂ into warmer instrument or discharge lines causes vaporization and pressure forcing the SLH₂ back to the bulk SLH₂ where cooling causes a reverse surge: such an oscillation results in an increased heat leak.

e. Aging.

Aging of the solid hydrogen particles in SLH₂ could result in particle settling or change in critical flow velocity of the SLH₂. Subsequent settling would result in overpressurization of the SLH₂ flow.

f. Electric Charge Buildup.

While investigation has shown that electric charge buildup in flowing LH₂ is not a great concern, the accumulation of electric charge in flowing SLH₂ has not been definitively excluded. The elimination of ignition sources might be compromised during SLH₂ flow operations.

g. Ortho-Para-Hydrogen Conversion.

The product is at least 95 percent para-hydrogen in normal production of LH₂. The equilibrium content of para-hydrogen at SLH₂ temperature 13.8 K (-435.2 °F) is 100 percent; therefore, any ortho-hydrogen will be converted to para-hydrogen. The heat generation by this residual ortho-to-para conversion acts as an additional heat leak into the system. This conversion is slow, but finite if no catalyst is present. At 20 K (-424 °F) the heat of conversion for normal hydrogen is 525 J/g (226 Btu/lb). If the rate of decrease (-dx/dt) of ortho-hydrogen concentration is a bimolecular reaction and can be described by

$$(-dx/dt) = k x^2 \quad (\text{Eq 2})$$

where:

x = the fraction of ortho-hydrogen

k = the rate constant, 0.0114/h

The spontaneous conversion of ortho-hydrogen to para-hydrogen even occurs in the solid state, in which the conversion rate may be even higher. Appendix B, Example 4 contains the analysis of heat leak and ortho-para conversion on SLH₂ systems.

h. Helium Solubility.

The solubility of helium in SLH₂ is a concern if helium is used to pressurize the SLH₂ storage vessel. Although it has not been determined for SLH₂, several reports are available for the solubility of helium in LH₂ over a range of temperature and pressure (Smith 1952 and Streett, Sonntag, and Van Wylen 1964).

206h

CHAPTER 3: MATERIALS FOR HYDROGEN SERVICE

Note: Awareness of the unique properties of hydrogen and the effect of cryogenic temperatures on material behavior is essential.

300 CONSIDERATIONS FOR MATERIALS SELECTION

a. General.

A hydrogen system can consist of structural members, vacuum jackets, valve bodies and valve seats, electrical and thermal insulation, gaskets, seals, lubricants, and adhesives and will involve a multitude of different materials. The appropriate data must be available for the selection of a material for a particular use. The selection of a suitable material for hydrogen applications requires consideration of the following as appropriate:

- (1) Properties suitable for the design and operating conditions
- (2) Compatibility with the operating environment
- (3) Availability of selected material and appropriate test data for it
- (4) Corrosion resistance
- (5) Ease of fabrication, assembly, and inspection
- (6) Consequences of a material failure
- (7) Toxicity
- (8) Hydrogen embrittlement
- (9) Potential for exposure to high temperature from a hydrogen fire
- (10) Cold embrittlement
- (11) Thermal contraction
- (12) Property changes that occur at cryogenic temperatures

Note: Many hydrogen material problems involve welds or the use of an improper material, such as a 400-series stainless steel for a pressure gage bourdon tube.

b. General Materials.

A number of materials have been found acceptable for use in hydrogen service for conditions ranging from low temperature/low pressure to high temperature/high pressure. Table A5.1 gives a summary of the compatibility of some materials for hydrogen service. Table A5.2 gives a selection of materials for many typical applications. The selection of a material depends on the specific conditions of operation. The tables are provided as guidelines.

c. Metallic Materials.

Metals with a face-centered cubic structure, such as, austenitic stainless steels, aluminum alloys, copper, and copper alloys, generally are satisfactory for hydrogen service. Nickel, a face-centered cubic material, is an exception and generally is not used because it is subject to severe hydrogen embrittlement. Unstabilized austenitic stainless steel (some of the 300 series) can revert to a martensitic structure when stressed above the yield stress at low temperature, reducing the ductility of the steel. Ordinary carbon steels may be used in GH₂ service, but they lose their ductility at LH₂ temperatures and are considered too brittle for low-temperature service. Iron, low alloy steels, chromium, molybdenum, niobium, zinc, and most body-centered cubic crystal structure metals are not acceptable for use at cryogenic temperatures. The yield and tensile strength of metals with a body-centered cubic structure depend to a great extent on the temperature, and the materials exhibit a substantial loss of ductility within a narrow temperature range.

- (1) Trapping sites have been identified in face-centered cubic metals and alloys; therefore, these materials should be evaluated carefully in making selections. Trapping is pronounced at low temperatures. It is important in the temperature region where hydrogen embrittlement is most pronounced. Trapping is not important in short-time GH₂ or LH₂ exposure.
- (2) The designation that a material is suitable for cryogenic service does not necessarily indicate that the material is

suitable for LH₂ or SLH₂ service. Nickel steels with 3.5, 5, and 9 percent nickel are considered satisfactory for cryogenic service with specific minimum temperature limits as follows:

190 K (-150 °F) for 3.5-nickel steel

129 K (-260 °F) for 5-nickel steel

76 K (-323 °F) for 9-nickel steel

d. Nonmetallic Materials.

Tables A5.1 and A5.2 list some nonmetallic materials that may be used in hydrogen service. The use of elastomers and plastics should be limited in gasketing, packing or other sealing elements in which failure as a result of fire could cause hydrogen leakage.

- (1) The valve seat materials should be the materials of standard industrial practice for GH₂ near room temperature (Moore, et al. 1959).
- (2) Teflon[®] or Kel-F[®] can be used in cold GH₂ or LH₂ systems for the following:
 - (a) Valve seats (modified Teflon[®], although Fluorogreen[®] is preferred)
 - (b) Soft coatings on metallic O-rings to provide more positive seal
 - (c) Flat, thin gaskets for tongue and groove flanges in which the gasket is shrouded on four sides
 - (d) Spacers in the vacuum area between liquid the flow tube and vacuum pipe
 - (e) Gland packing or seals (only if maintained near ambient temperature as in an extended bonnet of a shutoff valve)
- (3) All Teflon[®] gaskets must be captured on all sides to prevent cold flow and subsequent leakage. The contraction or shrinkage allows leakage when Teflon[®] is cooled from

ambient to cryogenic temperatures (NASA TM 104438 1992). Filled Teflon[®] materials, or Kel-F[®], are preferred to Teflon[®] for use in LH₂ service. Kel-F[®] has a higher tensile strength and is less brittle at cryogenic temperatures than Teflon[®]. Valves for liquid service over 2.1 MPa (300 psia) should use metal-to-metal seats because the pressure requires excessive seating force for the Kel-F[®] and Teflon[®] (Moore, et al. 1959).

e. Clad Materials.

The base metal for the component should be an acceptable material when a clad or lined component is used. The thickness used in pressure design should not include the thickness of the clad or lining. The allowable stress used should be that for the base metal at the design temperature. Clad components may be difficult to weld.

f. Gasket Materials.

Table A5.2 lists some gasket materials satisfactory for hydrogen service.

g. Welds.

Welds are susceptible to hydrogen embrittlement in all hydrogen environments. The heat-affected weld zone frequently produces hard spots, residual stresses, and a microstructure conducive to embrittlement. Post-weld annealing may be required to restore a favorable microstructure. Test programs with type 301 stainless steel and Inconel[®] 718 have shown that flaw growth in LH₂ or SLH₂ storage systems is considerably greater in the welds than in the parent metal. Type 347 stainless steel is very sensitive to cracking during welding and should not be used without taking proper welding precautions. Welding requirements are given in the ASME BPVC (1995) and ANSI/ASME B31.3 (1996).

h. Material Properties.

- (1) It generally is best to use the room temperature, or higher temperature if necessary for operational requirements, strength of a material in the design of cryogenic equipment, although the strength of materials generally tends to increase as their temperature is lowered. This recommendation is based on the recognition that cryogenic equipment must also operate at

room temperature (or higher), and temperature gradients are possible within the equipment. Many test conditions and the form of the material (such as plate, bar, wire, pipe, forgings, etc.) affect material properties; consequently, unless the conditions and forms are given and are applicable, material property values should not be considered as approved design values. Approved design values may be obtained, for example, from ASME BPVC (1995) that gives allowable stresses for materials used in pressure vessels. Table A5.3 presents the allowable stress for some representative materials from the ANSI/ASME B31.3 (1996). Tables A5.4 (elastic properties), A5.5 (mechanical properties), and A5.6 (thermal properties) give some typical property values at room temperature and LH₂ temperature for some materials suitable for LH₂ service.

- (2) The effect of exposure to hydrogen should be considered in setting the allowable stress for hydrogen systems. Often, the allowable stress for vessels or piping used for GH₂, LH₂, and SLH₂ is set at no greater than 50 percent of the minimum yield of the material at ambient temperature as an added safety factor (NASA TM 104438 1992).

i. Forbidden Materials.

Gray, ductile, or cast iron shall not be used in hydrogen service (29 CFR 1910.103 1996 and NFPA 50A 1994).

Note: Asbestos and asbestos impregnated with Teflon[®] were once recommended for hydrogen service, but they shall not be used because of the carcinogenic hazard of asbestos.

j. Quality Control.

Materials for hydrogen service should be carefully selected, and good quality control procedures should be used. A material shall not be used until appropriate testing and analysis have indicated that the material is satisfactory for its intended purpose if it is not known to be compatible with hydrogen. Materials used shall be compatible with GH₂, LH₂, and SLH₂ under the conditions (such as temperature and pressure) in which they will be used and shall conform to the specifications approved by the responsible engineering authority. The

properties used for design should be based on tests conducted under conditions that simulate service or worst-case conditions. Test techniques to investigate material compatibility with hydrogen should include the direct exposure of the materials. As appropriate, testing should include tensile, fracture toughness, crack growth, fatigue (including low-cycle fatigue), bend, and stress rupture over a range of pressures and temperatures. Only materials that have been evaluated for suitable fatigue life should be used because LH₂ or SLH₂ systems are subjected to cyclic loading. Materials for hydrogen systems should be selected after evaluations under interactions of stress, pressure, temperature, and exposure conditions.

Note: The designer should be careful in selecting material property values reported in the literature because test and material conditions are highly variable.

301 HYDROGEN EMBRITTLEMENT

a. General.

Hydrogen can cause a significant deterioration in the mechanical properties of metals. This effect is referred to as hydrogen embrittlement. Hydrogen embrittlement involves a large number of variables such as the temperature and pressure of the environment; the purity, concentration, and exposure time of the hydrogen; and the stress state, physical and mechanical properties, microstructure, surface conditions, and nature of the crack front of the material.

b. Types of Embrittlement.

- (1) Hydrogen embrittlement can occur in one or a combination of the following three forms:
 - (a) Environmental hydrogen embrittlement that has been observed in metals and alloys plastically deformed in a GH₂ environment. Deformations under such conditions lead to increased surface cracks, losses in ductility, and decreases in fracture stress. Cracks start at the surface.
 - (b) Internal hydrogen embrittlement caused by absorbed hydrogen. Small amounts of hydrogen may cause

premature failures in some metals; the failures may occur with little or no warning. Cracks start internally.

(c) Hydrogen reaction embrittlement that occurs when the absorbed hydrogen chemically combines with one or more of the constituents of the metal to form a brittle hydride. This reaction occurs more readily at elevated temperatures. Hydrogen has formed methane with the carbon in steels.

(2) Table A5.7 gives some of the characteristics of these embrittlement forms. Tables A5.8 and A5.9 list additional information on materials embrittlement. Table A5.8 summarizes the susceptibility of some materials to embrittlement in hydrogen at a 68.9 MPa (10,000 psi) and 295 K (72 °F). Table A5.9 gives the effects of exposure to air, helium, and hydrogen at various pressures on the yield strength, ultimate strength, and ductility of some aluminum alloys, nickel, nickel alloys, and copper alloys.

c. Effect on Mechanical Properties.

The mechanical properties of metals are reduced in the presence of hydrogen. Tables A5.8 and A5.9 give selected data for hydrogen effects on several metals and alloys. Studies indicate the following:

- (1) The susceptibility of an alloy to adverse hydrogen effects increases as the strength of the alloy increases.
- (2) Hydrogen embrittlement has been observed over a wide range of temperatures, but for many metals and alloys, the effect of internal and environmental hydrogen embrittlement is maximum in the temperature range of 200 to 300 K (-100 to 80 °F). (Swisher et al. 1974). In contrast, hydrogen reaction embrittlement is associated with higher temperatures; such as above room temperature.
- (3) The susceptibility of steel to hydrogen embrittlement increases as the hydrogen purity increases.
- (4) Susceptibility to embrittlement generally increases as the tensile stress level increases.

301c

- (5) Embrittlement leading to an increased crack growth rate results in a decreased fatigue life.

d. Surface and Surface Films.

The hydrogen compatibility of metastable austenitic stainless steels such as American Iron and Steel Institute (AISI) type 304 is markedly influenced by surface finish.

- (1) Severe ductility losses and extensive surface cracking have been observed in as-machined samples with a 64 rms finish (Appendix G) tested to failure in 69 MPa (10,000 psi) hydrogen. The extent of cracking could be minimized by removing the layer produced by machining.
- (2) Oxides probably are the most common form of surface film on metals and alloys. Fabrication and operation of engineering structures can lead to formation or growth of oxides. Oxides restrict hydrogen absorption and may influence the degree of embrittlement in any given exposure because oxides usually have a lower permeability than the base metals. Anomalies in the absorption and permeation of hydrogen in Inconel[®], austenitic stainless steels, aluminum alloys, copper, and low-alloy steels have been attributed to the oxide films.
- (3) Synthetic surface films must be ductile at their operating temperature. Copper and gold are recommended (McPherson 1995).

e. Effect of Electrical Discharge Machining.

The potential for hydrogen embrittlement is increased by electrical discharge machining. Electrical discharge machining is a commonly used technique for producing holes, notches, slots, or other cavities in electrically conductive material. Electrical discharge machining processes can introduce hydrogen into a machined component. Hydrogen is provided by the dielectric fluid (usually oil or kerosene) when it is ionized by the electrical discharge.

f. Effect of Trapping Sites.

An additional concern is that of trapping hydrogen at sites within the structure of the metal, including dislocations, grain and phase

boundaries, interstitial or vacancy clusters, voids or gas bubbles, oxygen or oxide inclusions, carbide particles, and other lattice defects. Hydrogen can be trapped at these sites because such defects occur in most metals. Trapping is most pronounced at low temperatures and is important in the near-room temperature region where hydrogen embrittlement is also pronounced.

g. Reducing the Effects of Hydrogen Embrittlement:

- (1) Hydrogen-induced losses in mechanical properties have been attributed to three independent primary factors:
 - (a) The development of a critical, absorbed, localized hydrogen concentration
 - (b) The existence of a critical stress intensity (crack length and applied or residual stress)
 - (c) The existence of a susceptible path for hydrogen damage
- (2) Successful loss prevention measures include coatings, elimination of stress concentrations, impurity additions to gas-phase hydrogen, oxidation treatments, proper grain size or grain size mix, specifications of inclusion morphology, and careful alloy selection. Some suggestions for addressing hydrogen embrittlement concerns include the following:
 - (a) Aluminum is one of the few metals known to show only minimal susceptibility to hydrogen, so its use effectively eliminates hydrogen embrittlement.
 - (b) Most GH_2 equipment is made of medium strength steel and most LH_2 equipment is made of stainless steel. Hydrogen embrittlement concerns are addressed through increased thickness, surface finish, welding techniques, and materials selection.
 - (c) Containers with thick walls of low-strength metals will generally contain hydrogen more safely than containers fabricated from similar alloys treated for high strength, subject to appropriate welding techniques.

301g

- (d) A metal or alloy is almost certain to have a lower resistance to fatigue than if hydrogen were not present if it is exposed to hydrogen and cyclic stresses. Designers should, in the absence of data, assume a substantial (up to fivefold) decrease in resistance to fatigue (NASA TM 104438 1992).
- (e) Avoid the use of body-centered cubic metals and alloys whenever practical. Cast iron shall not be used.
- (f) Hydride-forming metals and alloys should not be used as structural materials for hydrogen service. Their use requires careful consideration of operating temperatures and adverse effects of hydride formation.
- (g) Exposure temperatures below room temperature generally retard hydrogen reaction embrittlement; however, environmental and internal hydrogen embrittlement are increased in the temperature range of 200 to 300 K (-100 to 80 °F).

302 THERMAL CONSIDERATIONS IN MATERIALS SELECTION

a. Low-Temperature Mechanical Properties.

- (1) The selection of a structural material for use in LH₂ or SLH₂ service is based primarily on the mechanical properties (such as, yield and tensile strength, ductility, impact strength, and notch insensitivity) of the material. The material must have certain minimum values of these properties over the entire temperature range of operation, with appropriate consideration for nonoperational conditions such as a hydrogen fire. The material must be metallurgically stable so phase changes in the crystalline structure do not occur with time or repeated thermal cycling.
- (2) Three main categories of material behavior to be considered are the following:
 - (a) The transition from ductile to brittle behavior as a function of temperature

- (b) The modes of plastic deformation, particularly certain unconventional modes encountered at very low temperatures
 - (c) The effect of metallurgical instability and phase transformations in the crystalline structure on mechanical and elastic properties
- (3) Two thermal properties to be considered in the selection of a material for LH₂ and SLH₂ service are low-temperature embrittlement and thermal contraction.

b. Low-Temperature Embrittlement.

- (1) Some materials change from ductile to brittle behavior as their temperature is lowered. This temperature varies for different materials and can be much higher than cryogenic temperatures.

Example: The failure of an LNG storage vessel in Cleveland in 1944 is an example of low-temperature embrittlement and of the tragic consequences of a low-temperature embrittlement failure. An LNG storage vessel made of 3.5 percent nickel steel with a capacity of 4,248 m³ (150,000 ft³) ruptured and released 4,163 m³ (147,000 ft³) of LNG. The LNG ignited after having spread into nearby storm sewers. A nearby storage vessel of a different design collapsed from the fire and spilled its contents, which also burned. Flames were reported to have extended to a height of at least 2,800 ft. The results were 200 to 400 injuries and 128 deaths and an estimated \$6,800,000 (1944 dollars) in property damage (Zabetakis, 1967).

- (2) The Charpy impact test is commonly used to determine the ductility of a material (Edeskuty and Stewart 1996). Figure A5.1 shows the results of the Charpy impact test at various temperatures for several materials. The figure clearly shows the ductile-to-brittle transition of C1020 carbon steel and 201 stainless steel. The large decrease in the Charpy impact strength for the 9 percent nickel steel indicates it is

unsatisfactory for LH₂ service. In contrast, the Charpy impact strength for 304 stainless steel does not show a significant change, it actually increases slightly as the temperature decreases, indicating 304 stainless steel can be used for LH₂ service. The Charpy impact strength of 2024-T4 aluminum is low, but does not change much as the temperature decreases, indicating that it can be used for LH₂ service but with caution because of its low value.

- (3) Another indication of the ductile or brittle behavior of a material is given by the relationship of the yield and tensile strengths of the material as a function of temperature. The yield and tensile strengths of a material generally increase as the temperature decreases; but the rate of increase of the two properties gives an indication of the change in ductility of the material. Figure A5.2 shows the yield and tensile strengths of 5086 aluminum (a material considered satisfactory for LH₂ service) as a function of temperature. The figure shows that the tensile strength increases faster than the yield strength as the temperature is decreased. The distance between the two curves provides an indication of the ductility of the material, and in this case it indicates the material remains ductile. In contrast, Figure A5.3 shows the behavior of AISI 430 stainless steel, a material that becomes brittle. The two curves for AISI 430 stainless steel approach each other at LN₂ temperature, 77 K (-320 °F); therefore, the material becomes increasingly brittle as the temperature decreases, and it is not considered satisfactory for cryogenic service (McClintock and Gibbons 1960).

c. Thermal Contraction.

- (1) Materials generally have a positive thermal expansion coefficient although there are a few exceptions to this over limited temperature spans. The temperature span from ambient to cryogenic temperature is about 200 K (360 °F) or more. Such a large temperature decrease will result in a significant thermal contraction in most materials, and this contraction must be accommodated in the use of the material at cryogenic temperature. Figure A5.5 shows (using copper for example) that the thermal expansion coefficient of a material is itself a function of temperature.

- (2) About 90 percent of the total contraction from room temperature, 300 K (80 °F), to a temperature lower than LN₂ temperature, 77 K (-320 °F), will have occurred by a temperature of 77 K because of the decrease in the thermal expansion coefficient as a function of temperature for most materials. Figure A5.5 shows that a thermal contraction of about 0.3 percent in iron-based alloys, slightly over 0.4 percent in aluminum, and well over 1 percent in many plastics occurs in cooling from room temperature to cryogenic temperature. These values can be used for estimates. Figure A5.5 shows, for several materials, the total integrated thermal contraction from room temperature to lower temperatures.

CHAPTER 4: HYDROGEN FACILITIES

Note: The safe and successful use of hydrogen starts with knowing of and adhering to appropriate standards and guidelines for the design of the facilities.

400 SAFETY POLICY

a. General.

Safety shall be considered in all phases of a hydrogen facility life cycle, beginning with its initial design and continuing through its fabrication, construction, operation, maintenance, and ending with its decommissioning.

- (1) The safe operation of a hydrogen system depends on a facility with the necessary safety features designed and built into it and operating personnel appropriately trained in and cognizant of safety.
- (2) The safety of the design shall be reviewed in accordance with NHB 1700.1 (1993) before hydrogen facilities, equipment, and systems are constructed, fabricated, and installed. Safety review and concurrence procedures should include intended personnel operations. Construction and construction practices shall be in accordance with 29 CFR 1926 (1996).

b. Installation Pressure Systems Manager.

An Installation Pressure Systems Manager shall be designated to direct technical efforts; approve pressure vessels and pressurized systems (including vacuum) designs, repairs, configuration changes, etc. and act as the primary point of contact for all recertification activities. A Pressure Systems committee should be established. Where appropriate, the committee should conduct reviews, recommend requirements and procedures, maintain an overview of pressure system technology, participate in recertification activities, and provide guidance on pressure system safety to appropriate officials including the Pressure Systems Manager and safety officials (NMI 1710.3 1994).

400b

c. Fire Protection.

- (1) Due to the unique nature of NASA's mission, a number of specialized facilities and operations are required. Conventional fire protection doctrine and existing codes and standards may not be appropriate in some cases. Nevertheless, adequate safeguards shall be provided for all facilities and operations.
- (2) An analysis shall be conducted to identify all fire hazards and accomplish the following:
 - (a) Significant hazards shall be eliminated or reduced to acceptable risk levels (NHB 1700.1 1993).
 - (b) Where the hazard cannot be eliminated or reduced, the system components associated with the hazard shall be relocated to an area less threatening to people and property as directed by the AHJ.
 - (c) Where the hazard cannot be eliminated, reduced, or removed, the system components associated with the hazard shall be isolated within the facility so as not to pose a danger to the remainder of the structure or its occupants.
 - (d) Where the hazard cannot be eliminated, reduced, relocated, or isolated, protection shall be provided to ensure adequate levels of human and structural safety. Should a fire occur, the occupants of the facility shall be provided with protection to enable them to leave the area safely and the structure will be protected to ensure its continued integrity.

401 SAFETY REVIEWS

At each phase in the facility life cycle, specific safety tasks shall be accomplished to ensure safety during construction, operation, maintenance, and final disposition of the facility. Safety tasks identified in the Safety Management Plan for each facility acquisition should be tailored to include the appropriate tasks considering the size and complexity of the project and the associated safety risks. This

section describes possible safety tasks for new facilities and for modification and/or rehabilitation of existing hydrogen facilities.

a. New Facilities.

Safety assessment will be integrated into the overall facility design review of major projects. Each design review phase will address and evaluate the safety aspects of the project consonant with its level and maturity.

- (1) Concept Design Review (10 Percent Review). Purpose and design performance criteria should be established. Proposed and selected design approaches and basic technologies should be delineated sufficiently to indicate the type and magnitude of the principal potential hazards. Applicable design codes, safety factors, and safety criteria should be specified. A preliminary hazards analysis shall be started. Appropriate safety tasks should be planned and become the foundation for safety efforts during the system design, manufacture, test, and operations.
- (2) Preliminary Design Review (30/60 Percent Review). Stress calculations for critical structures shall show that design codes, safety factors, and safety criteria have been met. The preliminary hazards analysis shall be completed; system/subsystem hazards analyses should be under way.
- (3) Critical Design Review (90 Percent Review). The design shall be reviewed for conformance to design codes, required safety factors, and other safety criteria. Proposed construction methods and arrangements shall make clear that construction hazards will be effectively controlled. Procurement documents, such as a statement of work (SOW) shall specify appropriate safety requirements. The system/subsystem hazards analyses shall be completed and close-out actions shall be proceeding. An operational hazards analyses shall be under way.
- (4) Design Certification Review (100 Percent Review). All project documentation (drawings, SOWs, specifications,) should be complete, reviewed, and approved. All hazards analyses shall be complete, including close-out actions. Actions from previous reviews should be verified as complete.

401a

- (5) Ongoing System/Subsystem Hazards Analyses. Hazards and operational analyses shall be continued during operations and testing.
- (6) Other Reviews. Other reviews that may be conducted consist of the following:
 - (a) Test Readiness Review. Operational procedures, along with instrumentation and control systems, shall be evaluated for their capacity to provide the required safety. Equipment performance should be verified by analysis or certification testing (NMI 1710.3 1994). It may be necessary to develop special procedures to counter hazardous conditions.
 - (b) Emergency Procedures Review. The safety of personnel at or near hydrogen systems should be carefully reviewed and emergency procedures developed in the earliest planning and design stages. Advance planning for a variety of emergencies such as fires and explosions should be undertaken so the first priority is to reduce any risk to life.
 - (c) Operational Readiness Review. An Operational Readiness Review may be required for any major facility change. Hydrogen hazards should be reviewed for compliance with, for example, NHB 1700.1 (1993).

b. Existing Facility Modification or Rehabilitation.

For minor modifications to, or rehabilitation of, existing hydrogen systems, the safety review process shall provide for review stages to include the following:

- (1) Preliminary Design and Layout.
 - (a) The initial request shall include a hazards analysis using the appropriate tools and equipment, such as, Failure Modes and Effects Analysis, Fault Tree Analysis, Sneak Circuit Analysis, Event Tree Analysis, and Hazard Operability Study for the safety task undertaken. This hazard analysis shall identify

all of the hazards associated with the facility or operations from the beginning of hydrogen use to the disposal of the hydrogen.

- (b) Consideration should be given in the design review and hazards analysis for the shutdown of transfer systems, for the automatic closing of special lines and systems, and for the use of isolation valves in various legs of multiple systems.

- (2) Final Design. Review of the final drawings, designs, structures, and flow and containment systems shall include a safety assessment review. Assessment reviews shall identify areas of compliance as required by local, state, and Federal agencies.

c. Safety Assessment Review.

The Safety Assessment Review shall be updated anytime a system or process is changed. An annual facility inspection shall be conducted and documented. A formal Operating and Support Hazard Analysis shall be performed as directed by the AHJ at the controlling NASA center. Significant hazards identified shall be eliminated or reduced to acceptable risk levels. Record of inspections and Operating and Support Hazard Analyses shall be retained on file at the involved installation for a minimum of four years (NHB 1700.1 1993).

d. Operating Procedures.

Operating procedures along with instrumentation and control systems shall be evaluated for their capacity to provide the required safety. Equipment performance shall be verified by analysis or certification testing.

e. Training.

Operator training shall be reviewed and demonstrated to be adequate before operations commence. Operator training shall be evaluated continuously (NHB 1700.1 1993).

401f

f. Emergency Procedures.

The safety of personnel at and near the hydrogen facility shall be carefully reviewed and emergency procedures developed at the earliest planning and design stages. Advance planning for a variety of emergencies such as fires and explosions shall be undertaken so the first priority is the reduction of risk to life.

402 GENERAL FACILITY GUIDELINES

The facility and structure design should include sufficient details for demonstrating satisfactory safety in the storage and transfer areas. The facility design should provide for good illumination, lightning protection, alarm systems, and gas detection and sampling systems. As delineated in Section 101, separate standards and guidelines address different portions of overall hydrogen systems; however, there are safety considerations for the design of facilities common to all portions or subsystems.

a. Electrical Considerations.

Areas where flammable hydrogen mixtures normally are expected to occur are classified as Class 1, Group B, Division 1. Areas where hydrogen is stored, transferred, or used and where the hydrogen normally is contained are classified as Class 1, Group B, Division 2, as a minimum. NFPA 70 (1993) should be consulted when deciding whether an area will be made safer by the more difficult Division 1 installation.

- (1) All electrical sources of ignition should be prohibited in classified areas, including open electrical arcing devices and heaters or other equipment that operate at elevated temperatures. This means using approved explosion-proof equipment (Class 1, Group B, Division 1) or selecting non-arcing equipment approved for Division 2 (NFPA 70 1993).
- (2) A Division 1 installation differs from a Division 2 installation mainly in its degree of isolation from the ignition sources that may occur in the electrical system. A Division 1 installation relies heavily on explosion-proof enclosures.

- (3) Explosion-proof equipment is equipment qualified by a testing laboratory as being explosion-proof for a specific gas. It means that the enclosure is strong enough to contain the pressure produced by igniting a flammable mixture inside the enclosure if code-required seals are properly used. The joints and threads are tight enough and long enough to prevent issuance of flames or gases that would be hot enough to ignite a surrounding flammable mixture. An explosion-proof enclosure is not gas tight. NFPA 70 (1993), KSC-STD-E-0002 (1976), and NFPA 496 (1982) give guidelines for installing and using explosion-proof equipment.
- (4) An alternative method for making equipment safe, other than explosion-proofing, is to locate the equipment in an enclosure purged and maintained above ambient pressure with an inert gas.
- (5) Intrinsically safe installations in accordance with NFPA 70 (1993) and ANSI UL913 (1988) may be used. The intrinsically safe installation should be approved for hydrogen service.
- (6) When properly classified equipment is not available, general-purpose equipment in general-purpose housing may be used if it is continuously pressure purged with clean air or nitrogen provided no GH₂ sources are plumbed into them. Positive indication of continued purge shall be provided. The purge system shall be in compliance with NFPA 496 (1982) and 29 CFR 1910.103 (1996). The cost of an installation will be reduced and safety increased if the items that might become ignition sources are located outside the hazardous area. Also, systems installed in the hazardous area, but not required during hazardous periods, may be built with general purpose equipment provided they are disconnected before the hazardous period begins. The conduits for such systems must be sealed in accordance with NFPA 70 (1993) when they leave the hazardous area.

b. Bonding and Grounding.

- (1) Mobile hydrogen supply units shall be electrically bonded to the system before discharging hydrogen (NFPA 50A 1994 and 29 CFR 1910.103 1996).

402b

402b

- (2) LH₂ containers, static and mobile, and associated piping shall be electrically bonded and grounded (NFPA 50B 1994 and 29 CFR 1910.103 1996).
- (3) NFPA 70 (1993) defines the terms “bonded” and “grounded” and lists sizes of grounding conductors and acceptable connections based on the expected amperage to ground.
- (4) All off-loading facilities shall provide easily accessible grounding connections and be located outside the immediate transfer area. Facility grounding connections should be less than 10 Ω resistance. Transfer subsystem components should be grounded before subsystems are connected.
- (5) Electrical wiring and equipment located within 0.9 m (3 ft) of a point at which connections are regularly made and disconnected shall be in accordance with NFPA 70 (1993) for Class I, Group B, Division 1 locations.

c. Roadways and Area Surfaces.

The roadways and area surfaces located below LH₂ piping from which liquid air may drop shall be constructed of noncombustible materials such as concrete. Asphalt shall not be used.

d. Transfer Piping.

Piping carrying hydrogen to the use point from the dewars, trailers, and storage vessels shall be installed above ground. Lines crossing roadways should be installed in concrete channels covered with an open grating. Hydrogen transmission lines shall not be located beneath electric power lines.

Example: A review of an explosion in one of the buildings of a test stand complex showed that the explosion resulted when galvanic corrosion and high pressure caused a GH₂ leak in an underground pipe. GH₂ was trapped under the test stand apron and entered several rooms. The explosion originated in the basement. Shock waves traveled through connecting ducts to a second room, causing a second explosion.

e. Elimination of Ignition Sources.

- (1) Lightning protection in the form of lightning rods, aerial cable, and ground rods suitably connected should be provided at all preparation, storage, and use areas. All equipment in buildings should be interconnected and grounded to prevent inducing sparks between equipment during lightning strikes. The design of lightning protection systems shall be in accordance with requirements of NFPA 780 (1995).
- (2) A discharge rod welded to the vent must be extended above the gas discharge point so normal venting GH_2 is always below the flammability point at the discharge rod tip for systems with static vent stacks where ignition of the vented GH_2 is a concern.
- (3) Strong static charges may be generated in flowing fluids containing solid or liquid particles in spite of all precautions. The sources may be unknown but could be caused by the rapid movement of particles in pipes or vessels during transfer. Sufficiently high potentials can be developed that will discharge as a spark. The following measures should be taken to limit spark generation potential:
 - (a) Bond and ground all metal parts of a test rig and the structure enclosing it.
 - (b) Use conductive machinery belts.
 - (c) Personnel shall ground themselves before touching or using a tool on hydrogen dewars or vents.
 - (d) Personnel should avoid wearing clothes made of nylon or other synthetics, silk, or wool. Pure cotton clothing is preferred. Nomex[®] material provides good antistatic qualities and provides some fire protection.
 - (e) Avoid electrostatic charge generation and accumulation. Lines, piping, and components within each system should be electrically

bonded across each connection and grounded. Plastic and composite pipes and vessels should have surface resistivity of between 10^5 and 10^{12} Ω/m^2 . Conductive coatings should be considered for use if necessary.

- (f) Electrical circuit designs should consider types of electrical insulation used and bonding techniques to prevent arcing.

(4) Spark Generation.

- (a) The energy required for ignition of flammable GH_2 -air mixtures is so small that even spark-proof tools can cause ignitions. All tools should be used with caution to prevent slipping, glancing blows, or dropping, all of which can cause sparks. Spark-proof tools should be used. Extra care should be taken if they are not available.
- (b) Conductive and nonsparking floors. Using conductive floors is advised for areas where hydrogen gas could accumulate, such as during transfer operations or around in-process piping. Care should be exercised not to destroy the safety properties of the conductive floor by cutting grooves in it, painting it with nonconductive paint, or allowing it to get dirty.

(5) Hot Objects, Flames, and Flame Arrestors.

- (a) Flame producing devices shall be prohibited within the exclusion area around a hydrogen facility.
- (b) Operations causing heat, flames, or sparks, such as welding or cutting, shall not be performed with hydrogen present.
- (c) Internal combustion systems, motor vehicles, or equipment employing internal combustion engines shall be equipped with exhaust system spark arrestors and carburetor flame arrestors (hydrogen approved) when operated within the exclusionary zone with hydrogen present.

- (d) Only flame arrestors specifically designed for hydrogen applications shall be used. Flame arrestors designed for hydrocarbon flames will not stop hydrogen flames. Also, flame arrestors effective against hydrogen-air flames may not stop hydrogen-oxygen flames. Flame arrestors will quench a flame if they can remove sufficient heat from the gas. The small quenching distance of 0.06 cm (0.024 in.) for hydrogen makes it difficult to develop flame arrestors and explosion-proof equipment for hydrogen. Sintered-bronze flame arrestors may be effective in stopping hydrogen flames. Sintered stainless steel is not as effective as sintered bronze. Arrestors should be well-maintained to minimize accidental ignition.

f. Illumination.

Adequate lighting shall be provided for night transfer operations (29 CFR 1910.103 1996). All lighting components shall be consistent with the electrical classifications of the operation area.

g. Testing.

Cryogenic components and systems shall be tested prior to acceptance for operational use. Piping and piping components shall be tested in accordance with ANSI/ASME B31.3 (1996) and vessels in accordance with ASME BPVC (1995). Testing shall include, but not be limited to, cold soak, thermal performance, pressure, leakage, welding quality, and vacuum retention.

403 BUILDINGS AND TEST CHAMBERS

Buildings and test chambers used in hydrogen service shall be consistent with the safety requirements of limiting personnel injury and facility damage in the event of hydrogen fires or explosions.

a. Buildings.

Separate buildings or special rooms shall be constructed in accordance with 29 CFR 1910.103 (1996), NFPA 50A (1994), and NFPA 50B (1994).

403a

- (1) Buildings shall be constructed of light, noncombustible materials on a substantial frame.
- (2) Window panes shall be shatterproof glass or plastic in frames.
- (3) Floors, walls, and ceilings should be designed and installed to limit the generation and accumulation of static electricity and shall have a fire resistance rating of at least 2 h.
- (4) Explosion venting shall be provided in exterior walls or the roof only. The venting area shall be not less than $0.11 \text{ m}^2/\text{m}^3$ ($0.033 \text{ ft}^2/\text{ft}^3$) of room volume (29 CFR 1910.103 1996). Vents may consist of one or a combination of the following, designed to relieve at a maximum internal pressure of 1.2 kPa (25 lb/ft²):
 - (a) Walls of light material
 - (b) Lightly fastened hatch covers
 - (c) Lightly fastened, outward-opening swinging doors in exterior walls
 - (d) Lightly fastened walls or roof
- (5) Doors shall be readily accessible to personnel. Doors should be hinged to swing outward in an explosion. Walls or partitions shall be continuous from floor to ceiling and securely anchored. At least one wall shall be an exterior wall, and the room shall not be open to other parts of the building.
- (6) Any heating in rooms and test cells containing hydrogen shall be limited to steam, hot water, or other indirect means.

b. Test Chamber, Test Cell, or Test Stand.

- (1) Test facilities should be constructed to adhere to appropriate safety standards and guidelines as directed by the AHJ at the controlling NASA center.
- (2) Test cells that cannot be ventilated sufficiently to cope with potential explosive hazards may eliminate this

hazard by providing an inert atmosphere of nitrogen, carbon dioxide, helium, steam, or other inert gas. The test cell pressure should be higher than atmospheric to avoid inward leakage of air in such cases.

Note: The system design shall prevent any possibility of asphyxiation of personnel in adjacent areas. The system design shall provide for prevention of personnel entering the cell unless confined space entry procedures are strictly followed.

- (3) Oxidants may be restricted in a test chamber by using a partial vacuum. The vacuum should be sufficient to limit the pressure of an explosion to a value that the system can withstand. The chamber should withstand the blast pressure in this case. Heads, baffles, and other obstructions in a pipe run should be designed to consider reflected shock waves. Ultimate stress values may be used because the reaction time during an explosion is so short.

c. Weather Shelter or Canopy.

Outdoor locations that include a weather shelter or canopy shall not be a structure enclosed by more than two walls set at right angles and shall have vent space provided between the walls and vented roof or canopy. Such walls shall be constructed of noncombustible materials.

d. Electrical Equipment.

- (1) Electrical equipment shall conform to the requirements of NFPA 70 (1993) for Class 1, Group B locations.
- (2) Materials for electrical equipment should be selected in accordance with established guidelines, such as KSC-STD-E-0002 (1976).
- (3) Electrical terminals should not turn or loosen when subjected to service conditions. Terminal points should be protected from shorting by eliminating foreign objects and contaminants.

- (4) All electrical equipment for outdoor locations within 4.6 m (15 ft), separate buildings, and special rooms shall be in accordance with NFPA 70 (1993) for Class I, Division 2 locations for GH₂ systems (29 CFR 1910.103 1996 and NFPA 50A 1994).
- (5) Electrical wiring and equipment located within 0.9 m (3 ft) of a point where connections are regularly made and disconnected shall be in accordance with NFPA 70 (1993) for Class 1, Group B, Division 1 locations for LH₂ systems. Electrical wiring and equipment located within 7.6 m (25 ft) of a point where connections are regularly made and disconnected or within 7.6 m (25 ft) of a LH₂ storage container, shall be in accordance with NFPA 70 (1993) for Class I, Group B, Division 2 for distances greater than 0.9 m (3 ft),.
- (6) When equipment approved for Class I, Group B, atmospheres is not commercially available, the equipment may be one of the following (29 CFR 1910.103 1996):
 - (a) Purged or ventilated in accordance with NFPA 496 (1982)
 - (b) Intrinsically safe
 - (c) Approved for Class I, Group C atmospheres

e. Ventilation.

- (1) Any structure containing hydrogen system components shall be adequately ventilated when hydrogen is in the system. Ventilation shall be established before hydrogen enters the system involved and continued until the system is purged. Ventilation should not be shut off as a function of an emergency shutdown procedure. Suspended ceilings and inverted pockets shall be avoided or adequately ventilated. Appendix B, Example 11 examines ventilation of occupied space in the presence of GH₂ releases.
 - (a) The normal air exchange should be about 1 ft³ of air per square foot of solid floor in the space.

- (b) Oxygen concentrations below 19.5 percent by volume require an air-line respirator in occupied spaces.
 - (c) Ventilation rates should be sufficient to dilute hydrogen leaks to 25 percent of the LFL; it is about 1 percent by volume for GH₂ (29 CFR 1910.106 1996).
 - (d) A more stringent GH₂ concentration limit of 10 percent of the LFL or about 0.4 percent by volume is required for permit-required confined space (29 CFR 1910.146 1996).
- (2) Adequate ventilation to the outdoors shall be provided. Inlet openings shall be located at floor level in exterior walls. Outlet openings shall be located at the high point of the room in exterior walls or roof. Inlet and outlet openings shall have a minimum total area of 0.003 m²/m³ (0.001 ft²/ft³) of room volume (29 CFR 1910.103 1996).
 - (3) Within the exclusion area, electric motors used to open vents, to operate valves, to operate fans, or to power ventilators shall be in accordance with NFPA 70 (1993).
 - (4) Hydrogen containers in buildings shall have their safety relief devices vented, without obstruction, to the outdoors at the minimum elevation to ensure area safety. Vents shall be located at least 15.2 m (50 ft) from air intakes (29 CFR 1910.103 1996). The discharge from outlet openings shall be directed or conducted to a safe location.
 - (5) GH₂ systems of more than 85 m³ (3000 ft³) shall not be located within 15.2 m (50 ft) of intakes for ventilation, air conditioning equipment, or air compressors (29 CFR 1910.134 1996). Stricter limits apply for LH₂ or SLH₂. The minimum distance to air compressor intakes, air conditioning inlets, or ventilating equipment shall be 23 m (75 ft) measured horizontally for all quantities.

403e

404 CONTROL ROOMS

a. Structure.

- (1) A pillbox, or concrete bunker, type of control room remote from the hydrogen test site is advisable. The control room of all hydrogen systems should provide a means of visual observation by direct or closed circuit television. The control room shall be designed to protect occupants from the most severe credible hazard.
- (2) Any window opening into a test cell where excessive pressures or fragments could be present must be considered a hazard. A window should be made as small as practical and should be of bulletproof glass or the equivalent if one is necessary. A mirror system or a movable steel panel can be used in some cases.
- (3) Any hydrogen-containing cell with openings to other rooms should be maintained at a negative pressure relative to the communicating rooms if wall openings and such cannot be sealed.

b. Piping Systems.

- (1) No hydrogen piping should enter the control room. Any hydraulic or pneumatic control valve should have a double diaphragm between the hydrogen line and the control room. Manual isolation valves shall be used for greater protection. Conduits should be sealed at the test cell end.
- (2) Existing GH₂ transmission lines buried underground in the control room area should be periodically proof tested and leak checked periodically. Buried lines are not allowed for new facilities.

c. Ventilation.

Ventilation of a control room shall be in accordance with Section 403e.

- (1) Particular attention should be paid to the ventilation or the air source for control rooms that may, in an

emergency, be enveloped in the combustible mixture or the products of combustion.

- (2) Hydrogen detection equipment should be located within the control room if hydrogen could possibly be present.

d. Inert Gases.

Ensure that instrumentation, gas sampling systems, and electrical conduits from purged electrical equipment cannot provide a leak path for inert gases to enter control rooms.

405 LOCATION AND QUANTITY-DISTANCE GUIDELINES

a. General.

Location and quantity distance (QD) requirements are based on the concept that the effects of fire, explosion, and detonation can be reduced to tolerable levels if the source of the hazard is kept far enough away from people and other facilities.

- (1) The location of hydrogen storage facilities should consider the effects of possible combustible cloud drift and the effects of thermal radiation should a fire occur.
- (2) Hydrogen storage facilities shall be located so all personnel and facilities, whether involved in the operation or not, shall be adequately protected by appropriate design, including distance of separation, shielding, barricading, or other means. Consideration for the siting of hydrogen storage is first, to protect personnel and facilities as above; and second, to protect the hydrogen storage vessel and contents from external hazards, hazards associated with the storage and use of oxidizers, or other propellants and fuels.
- (3) Trailers, vehicles, or test articles that contain hydrogen should be located outdoors or in buildings specially constructed to avoid entrapment of hydrogen in the event of leaks or spills. Avoid areas of entrapment around the site if outdoors. Distance will have to be determined by the many variables that can affect the location.

405b

b. Storage Type.

- (1) Storage for nonpropellant use at consumer sites shall be in accordance with the QD standards of 29 CFR 1910.103 (1996) (NFPA 50A 1994 and NFPA 50B 1994).
- (2) Storage at sites where LH₂ is used as a liquid propellant shall be in accordance with the QD guidelines of NSS 1740.12 (1993)(DoD 6055.9 1992).

c. Minimum Quantity Storage. QD determination should be handled on an individual basis by the AHJ at the controlling NASA center for quantities of hydrogen less than the minimum specified in the standards or guidelines. Each situation should be evaluated based on the hazard presented by the specific quantity of hydrogen being considered.

d. Location and QD Standards for GH₂.

- (1). The installation and location of GH₂ storage facilities shall conform to 29 CFR 1910.103 (1996) and NFPA 50A (1994).
- (2) The location of a GH₂ system, as determined by the maximum total contained volume of hydrogen, shall be in the order of preference indicated in Table A3.1 (29 CFR 1910.103 1996).
- (3) The minimum distance from a hydrogen system of indicated capacity located outdoors, in separate buildings or in special rooms, to any specified outdoor exposure shall be in accordance with Table A3.2. Table A3.2 lists the exceptions to the stated distances for systems in which protective structures such as adequate fire walls are located between the GH₂ system and the exposure.
- (4) GH₂ systems of 84.9 CM (3000 CF) or less located inside buildings shall be situated in the building so the following criteria are met:
 - (a) Adequately ventilated area as described in Section 403e
 - (b) 6.1 m (20 ft) from stored flammable materials

- (c) 7.6 m (25 ft) from open flames, electrical equipment, or other sources of ignition
 - (d) 15.2 m (50 ft) from ventilation intakes and air conditioning equipment
 - (e) 15.2 m (50 ft) from other flammable gas storage
 - (e) 7.6 m (25 ft) from concentrations of people
 - (f) More than one system of 84.9 CM (3000 CF) or less may be installed in the same room, provided the systems are separated by at least 15.2 m (50 ft). Each system shall meet all the above requirements.
- (5) GH₂ systems of more than 85 m³ (3000 ft³) shall not be located within 15.2 m (50 ft) of intakes for ventilation, air conditioning equipment, and air compressors (29 CFR 1910.134 1996).

e. Location and QD Standards for Nonpropellant Use of LH₂.

- (1) LH₂ storage for nonpropellant use shall be in accordance with 29 CFR 1910.103 (1996) and NFPA 50B (1994).
- (2) The location of LH₂ storage, as determined by the maximum total quantity of LH₂, shall be in the order of preference as shown in Table A3.3 (29 CFR 1910.103 1996).
- (3) The minimum distance from LH₂ systems of indicated storage capacity located outdoors, in a separate building, or in a special room to any specified exposure shall be in accordance with Table A3.4 (29 CFR 1910.103 1996 and NFPA 50B 1994).
- (4) Portable LH₂ containers between 150 and 189.2 L (39.63 and 50 gal) capacity housed inside buildings, not located in special rooms, and exposed to other occupancies shall comply with the following minimum requirements:

- (a) Located 6.1 m (20 ft) from flammable liquids and readily combustible materials
 - (b) Located 7.6 m (25 ft) from ordinary electrical equipment and other sources of ignition including process equipment or analytical equipment
 - (c) Located 7.6 m (25 ft) from concentrations of people
 - (d) Located 15.2 m (50 ft) from air intakes, air conditioning equipment, or air compressor intakes
 - (e) Located 15.2 m (50 ft) from storage of other flammable gases or storage of oxidizing gases
 - (f) Welding, cutting operations, and smoking prohibited while LH₂ is in the room
 - (g) Area adequately ventilated as described in Section 403e; safety relief devices on the LH₂ containers vented directly outdoors to a suitable vent stack or vented to a suitable hood
- (5) The minimum distance to air compressor intakes, air conditioning inlets, or ventilating equipment shall be 23 m (75 ft) measured horizontally for all quantities of LH₂.

f. Location and QD Guidelines for Propellant Use of LH₂.

- (1) The storage of LH₂ for use as a liquid propellant shall be in accordance with NSS 1740.12 (1993) and DoD 6055.9 (1992).
- (2) The siting of LH₂ storage vessels in systems in which the LH₂ is used as a propellant requires considerations of the quantities of LH₂ and other chemicals used; such as, other fuels and oxidizers. The QD separations are based on the compatibility or incompatibility of LH₂ and these materials in addition to the material classification as to hazard group. LH₂ is classified as a Hazard Group III, Compatibility Class C material as shown in Table A3.5.

- (a) Hazard Group III materials are the liquid propellants for which the hazards result from the pressure rupture of the storage container. The hazards that could result are fire, explosion, and fragmentation.
 - (b) Class C materials are the liquid chemicals compatible with LH₂ used as propellants. This determination is based on whether when stored together there is a significant increase in the probability of an accident, or for a given quantity, a significant increase in the magnitude of the effects of such an accident.
- (3) The combined quantity of the two propellants shall be used to determine the hazard when incompatible liquid propellants are not separated by the required distances or provisions are not made to prevent their mixing. The total quantity of the two propellants is corrected by a Liquid Propellant Explosive Equivalent Factor (E) given in Table A3.6 because perfect mixing does not occur in accidents. The equivalent amount of propellant is determined as shown in Equation 3.

$$W = E(W_{LH_2} + W_{OTHER}) \quad (\text{Eq 3})$$

where:

- W = the equivalent weight of propellant (lbs)
- W_{LH₂} = the weight of LH₂ (lbs)
- W_{OTHER} = the weight of the incompatible propellant (lbs)
- E = the Liquid Propellant Explosive Equivalent Factor (from Table A3.6)

- (4) The QD values are determined as follows:
- (a) Table A3.7 gives the QD guidelines for LH₂, a Hazard Group III material, and compatible and incompatible materials. The quantity of LH₂ is found in columns 1 and 2. The separation from other Hazard Group III, Class C materials is in column 5. Class D materials are in columns 3 and 4, depending on whether the LH₂ storage is unprotected or protected, respectively.

- (b) Table A3.8 gives the QD guidelines for LH₂ and other propellants and oxidizers from Hazard Groups I, II, and III. The total quantity of material for LH₂ and Hazard Group I and II were calculated using Equation 3. This quantity is used in column 1. The quantity of Hazard Group IV materials is used in column 1 when they are present. Columns 3 and 4 give intraline separation based on barricaded or unbarricaded storage, respectively.

g. Location and QD Guidelines for SLH₂.

Specific experimental data for SLH₂ QD determinations are not available; therefore, no standards or guidelines are published for SLH₂ storage siting. The total mass of SLH₂ considered, can be treated as LH₂ equivalent and the appropriate QD standard or guidelines applied. However, the increased hazards associated with SLH₂, such as air contamination and pressure control, suggest that the QD guidelines for LH₂ propellant be used.

h. Location and QD Guidelines for Piping and Other Hydrogen Systems.

- (1) Hydrogen systems other than those covered by 29 CFR 1910.103 (1996) do not have any QD standards established. It is recommended that the QD standards established by 29 CFR 1910.103 (1996) be applied as appropriate.
- (2) A distance of 7.6 m (25 ft) free of inhabited buildings shall be maintained on either side of the pipelines used for the transfer of Groups II and III propellants between unloading points and storage areas or between storage areas and points of use for LH₂ used as a propellant (NSS 1740.12 1993 and DoD 6055.9 1992).

406 EXCLUSION AREAS

a. General.

Standards and guidelines for the location of hydrogen systems effectively define an exclusion area in which access is limited to necessary personnel (must meet specified training requirements), equipment (must meet specified requirements for elimination or control of ignition sources), and operations (must be consistent with the requirements of safety to personnel and reducing risks to adjacent facilities) (29 CFR 1910.103 1996, NFPA 50A 1994, and NFPA 50B 1994). These standards and guidelines should be used as appropriate for control of access and activities permitted in the vicinity of any hydrogen systems, such as storage, transmission piping, and test facilities.

- (1) The area within 4.6 m (15 ft) of GH₂ equipment, or 7.6 m (25 ft) of LH₂ equipment, shall be kept free of weeds, dry vegetation, and combustible materials (29 CFR 1910.103 1996, NFPA 50A 1994, and NFPA 50B 1994). Only combustible materials required for test purposes shall be allowed in the exclusion area.
- (2) QD standards and guidelines provide separation of hydrogen systems and inhabited areas and represent a minimum exclusion area.
- (3) Site specific requirements may establish an additional area, a control area, in which access is physically limited by fencing and control gates.

b. Access Control.

Personnel access to any area containing hydrogen shall be considered as a potentially hazardous event and such entrance shall be by authorized personnel only. Personnel entering hydrogen system exclusion areas or control areas shall be provided necessary and sufficient clothing, equipment, detection devices, and respiratory devices as required (29 CFR 1910.132 1996, 29 CFR 1910.133 1996, 29 CFR 1910.134 1996).

- (1) Access is limited to authorized personnel (29 CFR 1910.103 1996 NFPA 50A 1994) for GH₂ systems.
- (2) Access is limited to authorized personnel (29 CFR 1910.103 1996 and NFPA 50B 1994) for LH₂ systems.

406b

- (3) The number of personnel at an operating location shall be the minimum consistent with safe and efficient operation for LH₂ propellant systems. Tasks not necessary to the performance of a hazardous explosives operation shall not be performed in the same location as the hazardous operation. Personnel not needed for the hazardous operation will not be allowed in hazardous locations. Personnel limits shall allow for necessary supervision and transients. Sufficient personnel shall be available to perform a hazardous operation safely and, in the event of accident, to obtain help and aid the injured (NSS 1740.12 1993).
- (4) Access is limited to authorized personnel for test chambers, test stands, and test cells. Such access shall be governed by guidelines established by the AHJ at the controlling NASA center.
- (5) Test cells and buildings in which combustible mixtures exist in the atmosphere shall not be entered under any condition. Personnel shall be warned of the presence of combustible mixtures or low oxygen concentrations (29 CFR 1910.1200 1996). Warning systems such as approved vapor detectors, sensors, and continuous sampling devices shall be employed to ensure that the test cell environment is safe. The warning and detection devices shall operate audible and visible alarms. These systems shall be designed and installed to allow for the operation of equipment needed to reduce possible hazards. Examples include operation of auxiliary exhaust systems for venting upon the detection of flammable mixtures, operation of purging systems, and automatic operation of blocking and control valves.

c. Placarding, Posting, and Labeling.

Exclusion areas and control areas shall have placards, postings, and labels displayed so personnel shall be aware of the potential hazard in the area.

- (1) The location of GH₂ systems shall be permanently placarded as follows: HYDROGEN - FLAMMABLE GAS - NO SMOKING - NO OPEN FLAMES. Each portable container shall be legibly marked with the

name "Hydrogen". Each manifold hydrogen supply unit shall be legibly marked with the name HYDROGEN or a legend such as "This unit contains hydrogen" (29 CFR 1910.103 1996 and NFPA 50A 1994).

- (2) Storage sites for LH₂ systems shall be fenced and posted to prevent entrance by unauthorized personnel (29 CFR 1910.103 1996 and NFPA 50B 1994).
 - (a) Sites shall be placarded as follows:
LIQUEFIED HYDROGEN - FLAMMABLE
GAS - NO SMOKING - NO OPEN FLAMES.
 - (b) A sign shall be placed on the container near the pressure-relief valve vent stack or on the vent stack that warns against spraying water on or in the vent opening.
- (3) Placards stating the maximum number of workers and transients permitted at any one time and the maximum amount of propellant materials and their Groups/Classes shall be posted for LH₂ propellant systems in a conspicuous place in all buildings, cubicles, cells, rooms, and storage areas containing propellant and similar materials. Personnel and material limits and the placard must be kept current and maintained for legibility. Placards must be of sufficient size and color that they are readily visible to personnel entering the work area. Local or DoD placards may be used (NSS 1740.12 1993).
- (4) Placarding, posting, and labeling for test chambers, test stands, and test cells shall be determined by the AHJ at the controlling NASA center.
- (5) Safety showers shall be placarded: NOT TO BE USED FOR TREATMENT OF CRYOGENIC BURNS.

407 PROTECTION OF HYDROGEN SYSTEMS AND SURROUNDINGS

a. Barricades.

All hydrogen containing vessels, piping, and other equipment should be protected from potential sources of shrapnel. Barricades can provide necessary protection in many circumstances.

- (1) Barricades serve two purposes: to protect uncontrolled areas from the effects of a hydrogen system failure and to protect the hydrogen system from the hazards of adjacent or nearby operations. It is highly desirable to design pressure vessels, piping, and components so failure caused by overpressure or material properties will not produce shrapnel; the system will leak its contents before it ruptures.
- (2) The possibility of system rupture caused by impact from adjacent hardware should be considered in locating the hydrogen system. Barricades should be located adjacent to the expected fragment source and in a direct line of sight between it and the facility to be protected because barricades have been shown to be most effective against fragments and only marginally effective in reducing overpressures at extended distances from them. If this is not possible, a barricade may be placed adjacent to the facility to be protected and in a direct line of sight between it and the expected fragment source.
- (3) Protection should be provided against failures that could yield shrapnel when reciprocating or high-speed equipment, such as a hydrogen pump, are required at hydrogen storage and use facilities. The equipment housing provides partial protection in many instances.
- (4) Appropriate fragment protection can be achieved in some applications by blast curtains and/or blast mats placed adjacent to the vessel or equipment to be protected.
- (5) The most common types of barricades are earthworks (mounds) and earthworks behind retaining walls (single-revetted barricades). A mound is an elevation of naturally sloped dirt with a crest at least 0.91 m (3 ft) wide. Single-revetted barricades are mounds modified by a retaining wall on the side facing the potential hazard source.
- (6) Barricades are constructed near potential explosion sources or in front of structures and facilities located near potential explosion sources. They are intended as protective devices to arrest fragments or attenuate blast

waves. Results of analyses and tests show (AMCP-706-180 1972 and Baker, et al. 1978) the following:

- (a) Barricades reduce peak pressures and impulses behind the barricades; however, blast waves can re-form under some circumstances.
- (b) Single-revetted barricades are more efficient in reducing peak pressures and impulses than mounds.
- (c) Values of peak pressure and impulse are greatly influenced by the height above ground and barricade location, dimensions, and configuration.
- (d) Barricades are often needed in hydrogen test areas to shield personnel, dewars, and adjoining areas from blast waves and fragments. Barricades should be placed adjacent to the fragment source for maximum fragment protection (AMCP-706-180 1972 and Baker, et al. 1978).
- (e) Barricades, when required, should block the line-of-sight between any part of equipment from which fragments can originate and any part of the protected items. Protection of a public roadway shall assume a 3.66 m (12 ft) high vehicle on the road.

b. Liquid and Vapor Travel and Confinement.

- (1) LH₂ or SLH₂ spills, such as those that might occur from the rupture of a storage vessel, could result in a brief period of ground-level flammable cloud travel. The quick change from a liquid to a vapor and the thermal instability of the cloud cause the hydrogen vapors to mix quickly with air, disperse to nonflammable concentrations, warm up, and become positively buoyant. The presence of SLH₂ briefly prolongs this time period. Site specific information should determine whether natural dispersion of the spill or confinement of the spill is preferred.

407b

- (2) Barricades should not cause excessive confinement that might lead to detonation rather than simple burning of escaped hydrogen. LH₂ spill tests conducted inside an open-ended (U-shaped) bunker without a roof produced detonation of the hydrogen-air mixture (Cloyd and Murphy 1965).
- (3) Although storage facilities for liquefied natural gas are required by law to include liquid-containment dikes, the use of dikes and barricades around LH₂ or SLH₂ storage facilities may prolong ground-level travel of the flammable cloud. It may be preferable to not use dikes and barricades to take advantage of the turbulent mixing of hydrogen with ambient air induced by vaporization of spills. Where it is necessary to locate LH₂ or SLH₂ containers on ground that is level with or lower than adjacent storage containers for flammable liquids or LOX, suitable protective means should be taken (such as diking, diversive curbs, sloped areas, and grading), with respect to the adjacent storage containers, to prevent accumulation of liquids within 15.2 m (50 ft) of the LH₂ or SLH₂ containers (NFPA 50B 1994).
- (4) Pipeline ruptures may result in extended ground-level travel of a flammable cloud. Conditions also could be aggravated by the orientation of the pipeline for pipeline ruptures. Ground-level cloud travel may be prolonged by reduced spill or momentum-induced cloud turbulence and the long-term cooling of the ground for prolonged, gentle spills and pipeline ruptures. Hydrogen detectors should be positioned to indicate the possible ground-level travel of flammable mixtures.
- (5) No sewer drains shall be located in an area in which an LH₂ or SLH₂ spill could occur.

c. Shields and Impoundment Areas.

- (1) The facility should include impoundment areas and shields for diverting spills to control the extent of liquid and vapor travel caused by spills. The loading areas and the terrain below transfer piping should be graded toward a sump or impoundment area. The surfaces within these areas should be cleared of

flammable materials. Including barriers and insulated areas within the impoundment areas provides surface control of evaporation, especially during small leaks.

- (2) The use of crushed stone in the impoundment area can provide added surface area for LH₂ dissipation.
- (3) Ignition of hydrogen-air mixtures in free space usually results in combustion or deflagration, but with a confining or partially confining system geometry a deflagration can evolve into a detonation. The facility guidelines and planned installations should eliminate possible confining spaces developed by the equipment, tankage, and piping. With flame burning in and around a collection of pipes or structures, sufficient turbulence may develop to cause a deflagration to evolve to a detonation even in the absence of gross confinement.

408 FIRE PROTECTION

a. General.

Preventive measures against fires should include automatic or manual process shutdown systems, sprinklers, deluge systems, water spray systems, dry-chemical extinguishing systems, and Halon systems. The fire safety policy shall be in accordance with NHB 1700.1 (1993), NSS 1740.11 (1993), and NHB 7320.1 (1982). Facilities shall provide appropriate automatic fire detection and suppression system for hydrogen systems containing significant hazards.

- (1) Hydrogen fires normally are not extinguished until the supply of hydrogen is shut off because of the danger of reignition or explosion. Reignition may occur if a metal surface adjacent to the flame is not cooled with water or by other means.
- (2) Large quantities of water should be sprayed on adjacent equipment to cool the equipment and prevent its involvement in any fire that occurs. Combination fog and solid stream nozzles have been preferred to permit widest adaptability.
- (3) Care shall be exercised to prevent water from entering the vent openings when using water for hydrogen fire suppression involving LH₂ storage systems (NFPA 50B 1994).

- (4) Small hydrogen fires have been extinguished by dry chemical extinguishers or with carbon dioxide, nitrogen, and steam.
- (5) Water spray systems shall be provided for hydrogen storage containers, grouped piping, and pumps where potential fire hazard exists. The system(s) shall be arranged to deliver a uniform spray pattern over 100 percent of the container surface, pumps, and adjacent piping. The minimum spray rate is $8.14 \text{ L/min}\cdot\text{m}^2$ ($0.2 \text{ gpm}\cdot\text{ft}^2$) of exposed surface. Manual control stations shall be located outside the hazardous area, but within effective sight of the facility protected. Remote control capability shall be provided as directed by the AHJ. The design, installation, testing, and maintenance of fixed, water spray systems shall be in accordance with 29 CFR 1910.163 (1996) and NFPA 15 (1996). With the exception of preprimed, high speed systems, water spray systems shall be of the deluge valve and open spray nozzle type. The systems are provided to protect defined hazardous equipment and areas and are not intended for complete facility protection.
- (6) The fire protection provided should be determined by an analysis of local conditions of hazard within the plant, exposure to other properties, water supplies, the probable effectiveness of plant fire brigades (such personnel must be trained to fight hydrogen fires), and the time of response and probable effectiveness of fire departments.
- (7) A fire hydrant or 2-in. diameter hose bib shall be provided adjacent to all LH₂ storage areas for wash down (NHB 7320.1 1982).

b. Exposure Protection.

- (1) Fires can damage objects by heat fluxes transmitted by radiation and convection. Much analytical and experimental work has been done on heat radiation from flames to surroundings. Existing models do not completely describe the complex phenomena. Factors that complicate the application of theory to heat radiation safety include changes in flame motion, turbulence, temperature profiles, flame size and shape, weather conditions, wind effects on back radiation, and flame emissivities.
- (2) Table A2.5 shows damage caused by various radiation levels. The damage also depends on the time history of the

radiation. Atmospheric water vapor is very effective in absorbing the radiation because the water molecules are responsible for much of the infrared radiation from the hydrogen flame. A 1 percent concentration of water vapor in the atmosphere (corresponding to a relative humidity of about 43 percent at ambient temperature) will reduce the radiation flux at least two orders of magnitude at a distance of 100 m (328 ft) or greater. Figure A2.9 gives the radiant intensity ratio as a function of distance from a hydrogen fire for various concentrations of atmospheric water vapor.

- (3) Further comparisons of hydrogen fires with hydrocarbon fires show a lower smoke inhalation danger with hydrogen fires, but smoke inhalation remains a major cause of injuries and deaths in a hydrogen fire.
- (4) Figure A2.5 gives safe limits for the exposure of personnel and equipment to thermal-radiation-flux exposure levels that cover a wide range.

c. Deluge Systems.

- (1) Strong consideration should be given to the installation of deluge systems along the top of storage areas for secondary fire protection. The deluge systems should be capable of being manually or automatically actuated. Also, any surface capable of becoming an ignition source should be cooled to not constitute a hazard. Fire extinguishing systems shall be used to protect manifold piping, relief vents, and transfer pump facilities but not for vent stack openings.
- (2) Rooms containing cryogenic and flammable fluids shall also be provided with fire and explosion protection. The rooms shall have a continuously operating exhaust system with a flow of about $0.3 \text{ m}^3/\text{min}\cdot\text{m}^2$ ($1 \text{ ft}^3/\text{min}\cdot\text{ft}^2$) of floor area. With the detection of a flammable gas at 20 percent of the LFL, the exhaust capacity should be doubled.
- (3) Storage vessels shall be provided with water deluge systems designed to provide for at least $0.02 \text{ m}^3/\text{min}\cdot\text{m}^2$ ($0.5 \text{ gal}/\text{min}\cdot\text{ft}^2$) on vessel surfaces and auxiliary fittings. Deluge systems shall be actuated by temperature rise detectors and remote, manual control. Enough hydrant outlets shall be located to enable use of charged hoses at each operation involving equipment in hydrogen service.

409 DOCUMENTATION, TAGGING, AND LABELING OF STORAGE VESSELS, PIPING, AND COMPONENTS

a. General.

A uniform system for the identification of hydrogen vessels, piping, and components shall be established to promote greater safety and lessen the chances of error, confusion, or inaction, especially in times of emergency.

- (1) Each portable GH₂ container shall be legibly marked with the name "HYDROGEN" in accordance with 29 CFR 1910.103 (1996).
- (2) Each manifold GH₂ supply unit shall be legibly marked with the name "HYDROGEN" or a legend such as "This unit contains hydrogen" (29 CFR 1910.103 1996).
- (3) Each LH₂ container shall be legibly marked "LIQUEFIED HYDROGEN - FLAMMABLE GAS" (29 CFR 1910.103 1996).
- (4) A sign shall be placed on the container near the pressure-relief valve vent stack or on the vent stack that warns against spraying water on or in the vent opening (NFPA 50B 1994).

b. Documentation.

- (1) Each hydrogen pressure vessel or pressurized system (including vacuum systems) shall be marked to indicate it is certified or recertified for use and any special constraints or instructions required for safe operation of the pressure vessel or pressurized system (including vacuum systems).
- (2) Documentation for each pressure vessel or pressurized system shall be prepared and revised or updated periodically. It shall identify the organization or individual responsible for the pressure vessel or pressurized system and contain, as a minimum, a pressure vessel or pressurized system description, list of available drawings and documentation, analysis results, certification requirements, unique inservice inspection

requirements, and results of the most recent inspection (NMI 1710.3 1994).

c. Tagging.

The storage vessels, piping, and components, shall be tagged and coded to indicate the following as appropriate:

- (1) Contents
- (2) Capacity
- (3) Direction of flow as appropriate
- (4) Maximum allowable working pressure (MAWP)
- (5) Hydrostatic test pressure
- (6) Certified test pressure
- (7) Date, month, and year of last hydrostatic test
- (8) NASA or manufacturer part number
- (9) Operating temperature
- (10) Component number or identification per appropriate process schematic

d. Labeling.

The labeling of piping and components shall be uniform and convey the necessary information (ANSI/ASME A13.1 1981 and NHB 7320.1 1982).

- (1) Lettered legend marked "Hydrogen (by form)" in black letters on a yellow field.
- (2) The label will be white lettering on a blue field for piping and components for purge gases; or white lettering on a green field for purge liquids; however, labels with black letters on a yellow field should be used for high-pressure or high-temperature purge fluids.

409d

- (3) Labels with white letters on a red field should be used for piping and components for fire quenching materials.
- (4) Arrows shall be used to indicate direction of flow.
- (5) Additional information shall be included as necessary. See above.
- (6) Legends shall be applied close to valves or flanges and adjacent to changes in direction, branches, where pipes pass through walls or floors, and at intervals sufficient for identification on straight pipe runs.
- (7) Attention shall be given to visibility of the legend. Where pipe lines are located above or below the normal line of vision, the lettering shall be placed below or above the horizontal centerline of the pipe.

410 INSTRUMENTATION AND MONITORING

a. Instrumentation.

- (1) A hydrogen system should be adequately instrumented for the following:
 - (a) Monitor and control its operation.
 - (b) Provide performance data.
 - (c) Provide warnings and/or alarms for out-of-limits conditions.
 - (d) Indicate a hazardous condition, preferably with sufficient notice to permit it to be addressed.
- (2) Instrumentation used in a hydrogen system shall meet Class I, Division I/II, Group B requirements of NFPA 70 (1993) when appropriate.
- (3) Instrumentation used in a hydrogen system should have the following characteristics:

- (a) Be compatible with hydrogen and with all operating conditions it will experience, such as temperature and pressure.
 - (b) Permit local and/or remote operation and monitoring of the hydrogen system.
 - (c) Have the appropriate range, accuracy, and response time.
- (4) Instrumentation used in a hydrogen system that provides safety information should be redundant in number and type of transducer (pressure indicated locally by a pressure gage and remotely by a pressure sensor).
 - (5) Data from the instrumentation should be displayed so the operator has a clear indication of the status of the hydrogen system.
 - (6) Computer control and data acquisition systems should be used whenever possible and carefully checked out to verify they are properly interfaced with the instrumentation transducers.
 - (7) The instrumentation system (computer, data acquisition, transducer, and wiring) should be calibrated at installation in a hydrogen system and should be periodically recalibrated as directed by the AHJ at the controlling NASA center.
 - (8) Ancillary instrumentation, such as sampling equipment and a mass spectrometer for purity analysis, should be available on an as-needed basis.
 - (9) Instrumentation used in LH₂ and SLH₂ systems should be selected and installed to minimize heat leak to the cryogenic fluids.
 - (10) A wide selection of instrumentation options are available for the parameters commonly monitored in a hydrogen system.

b. Hydrogen Detection.

- (1) Hydrogen gas is colorless and odorless and normally not detectable by human senses. Means shall be provided for detecting the presence of hydrogen in all areas in which leaks, spills, or hazardous accumulations may occur. Refer to Chapter 6 for requirements and specifications for hydrogen detection.

410b

410b

- (2) A combination of portable and fixed installation hydrogen sensors should be used. Portable hydrogen detectors should be available for personnel entering an area in which hydrogen is leaking or may have leaked.
- (3) Hydrogen detectors shall meet Class I, Division I/II, Group B requirements of NFPA 70 (1993) where appropriate.

c. Fire Detection.

- (1) A hydrogen flame is nearly invisible, and the emissivity of a hydrogen fire is low; consequently, means should be provided for detecting the presence of a hydrogen flame in all areas in which leaks, spills, or hazardous accumulations of hydrogen may occur.
- (2) A hydrogen fire will cause changes in the surroundings that can be used to detect the fire. The changes commonly are called the signature of the fire. Although the nonluminous hydrogen flame makes visual detection difficult, there is a strong heat effect and turbulence of the surrounding atmosphere.
- (3) The hydrogen fire detection system should be capable of monitoring a large area over considerable distances.
- (4) The effects of lightning and sunlight should be considered in the use of IR detectors.
- (5) The combination of portable and fixed installation hydrogen fire detectors should be used. Portable hydrogen fire detectors should be available for personnel (including fire department) entering an area in which a hydrogen fire is possible.
- (6) Fire detectors shall meet Class I, Division I/II, Group B requirements of NFPA 70 (1993) where appropriate.

d. System Monitoring.

Remote television monitoring of a hydrogen system should be considered if the system is not visible from the Control Center.

411 EXAMINATION, INSPECTION, AND RECERTIFICATION

a. General.

- (1) All storage and piping installations, including their components, shall be inspected before the initial operations to ensure compliance with the material, fabrication, workmanship, assembly, and test requirements. The completion of all required examinations and testing shall be verified. Verification shall include, but should not be limited to, certifications and records pertaining to materials, components, heat treatment, examination and testing, and qualification of welding operators and procedures (NHB 1700.1 1993).
- (2) Comprehensive control is required of all systems used in GH₂, LH₂, and SLH₂ installations. A quality control program that will satisfy the NASA requirements and engineering design for all vessels, piping, components, materials, and test equipment shall be established.
- (3) Material identification is required for all piping and components used in fabrications and assemblies subjected to LH₂ temperatures. No substitutions for the materials and components specified in the engineering design are permitted except when the substitution has written approval of the AHJ at the controlling NASA center.

b. Examinations.

- (1) Examinations shall be performed in accordance with the ASME BPVC (1995). Visual examinations should verify dimensions, joint preparation (alignment, welding, or joining), and the assembly and erection of supports.
- (2) The piping and components should be examined before and during installation for the integrity of seals and other means of protection provided to maintain the special cleanliness or dryness requirements specified for LH₂ systems. Protective coverings should be examined for any damage or omission that would allow the component or piping to become wetted or contaminated beyond the limits specified in the engineering design. Components specified to be maintained under positive gas pressure should be examined to ensure conformance to the requirements.

411c

c. Testing and Recertification.

- (1) All NASA pressure vessels and systems shall be designed, inspected, tested, operated, and maintained in accordance with the requirements and standards listed in NMI 1710.3 (1994).
- (2) After installation, all piping, tubing, and fittings shall be tested and proved hydrogen gas tight at operating pressure and temperature using the appropriate test or tests (29 CFR 1910.103 1996, NFPA 50A 1994, and NFPA 50B 1994).
 - (a) The hydrostatic test pressure should be 1.5 times the MAWP.
 - (b) Pneumatic tests shall be approved by the AHJ at the controlling NASA center. The pneumatic test may be used in lieu of the hydrostatic test for hydrogen systems designed or supported so they cannot safely be filled with liquid or if the vessel or system cannot be readily dried, or is to be used in services in which traces of the testing liquid cannot be tolerated. The substitution requires that the parts of the system, when possible, are previously tested by hydrostatic pressure. The pneumatic test pressure should be 1.25 times the MAWP.
 - (c) After a cryogenic system is constructed and has passed the hydrostatic or pneumatic test, the system shall be cold tested with LN₂. Storage vessels that cannot support the weight of a 100 percent load of LN₂ should be filled with the equivalent weight of LN₂ that corresponds with a 100 percent load of LH₂ or SLH₂. LN₂ temperature should be maintained in the new system for a minimum of 1 h.
- (3) All welds shall be tested as required by ASME BPVC (1995) and ANSI/ASME B31.3 (1996). Unless the inner LH₂ or SLH₂ container is fully radiographed, all welds in or on the shell and heads, inside and outside, should be tested by the magnetic particle method, the fluorescent dye penetrant method, or by the ultrasonic testing method as appropriate. All cracks and other defects found should be repaired in accordance with the proper repair procedures.

- (4) A system to be used in hydrogen service shall be leak tested prior to operation. Leak testing generally occurs in conjunction with the pressure testing of the system. The system should be leak tested to the extent possible with inert gases before LH₂ is introduced into the system. Personnel and equipment shall be adequately protected during a leak check involving hydrogen, whether GH₂, LH₂, or SLH₂. Leak testing methods that may be used are described in NHB 1700.6 (1976).

d. Records.

Records shall be made and retained for each pressure vessel and pressurized system (including vacuum) inspection and recertification examination. The records shall be retained for the life of the pressure vessel or pressurized system in accordance with NMI 1710.3 (1994) or as directed by the AHJ at the controlling NASA center. The records should include the following:

- (1) Date of inspection or recertification examination
- (2) Identification of system, component, and piping
- (3) Test method (for example, hydrostatic, pneumatic, or sensitive leak test)
- (4) Test fluid
- (5) Test pressure
- (6) Hold time at maximum test pressure, if over 10 min
- (7) Test temperature
- (8) Locations, types, and causes of failures and leaks in components and welded joints, types of repair, and other applicable test records
- (9) Approval by NASA-assigned safety or design engineer

411e

e. Schedule.

The inspection and recertification schedule for each pressure vessel and pressurized system (including vacuum) shall be established by the Pressure System Manager at the controlling NASA center where the system is installed (NMI 1710.3 1994). NHB 1700.6 (1976) provides guidelines for the creation of inspection and recertification schedules.

CHAPTER 5: HYDROGEN STORAGE VESSELS, PIPING, AND COMPONENTS

Note: All vessels, piping, fittings, vents, stacks, and other system components used in hydrogen service shall be designed and operated to provide maximum protection to personnel and equipment.

500 GENERAL REQUIREMENTS

a. General.

All pressure vessels, pressurized components and pressurized systems (including vacuum) shall be designed, fabricated, installed, operated, periodically inspected, maintained, repaired, and certified/recertified in accordance with the applicable codes, standards, and guidelines (NMI 1710.3 1994).

b. Special Considerations.

The application of standards such as the ASME BPVC (1995), ANSI/ASME B31.1 (1995), and ANSI/ASME B31.3 (1996) for hydrogen storage and piping require special considerations as a consequence of the unique properties of hydrogen, such as hydrogen embrittlement.

c. GH₂ Temperature Considerations.

The reference to GH₂ in this guideline document normally has implied ambient temperature. However, the designer should identify the hydrogen systems in which GH₂ is at cryogenic temperature and select materials and design equipment appropriate to those conditions. This distinction is characterized by using ANSI/ASME B31.1 (1995) for GH₂ above 244 K (-20 °F), and ANSI B31.3 (1996) for cryogenic GH₂ below 244 K (-20 °F) (29 CFR 1910.103 1996).

501 STORAGE VESSELS

a. Fixed and Mobile Storage Systems for GH₂.

Containers for GH₂ storage shall be designed, constructed, and tested in accordance with appropriate requirements of ASME BPVC (1995) or designed, constructed, tested and maintained in accordance with Department of Transportation (DOT) specifications and regulations as appropriate. Permanently installed containers shall be provided with substantial noncombustible supports or firm noncombustible foundations (29 CFR 1910.103 1996, NFPA 50A 1994, and NMI 1710.3 1994).

- (1) Large volumes of GH₂ should be stored outdoors in mobile or fixed cylinders. Mobile tube trailers of approximately 2000 CM (70,000 CF) capacity, pressurized to about 16.5 MPa gage (2400 psig), have been state of the art for many years and have not exhibited any undue operating problems. GH₂ vessels for service to 68.9 MPa (10,000 psia) are available. Vessels for very large volumes and higher gas pressures have not always been trouble free. Guidelines include the following:
 - (a) Materials shall be selected in accordance with ASME BPVC (1995) and 49 CFR (1995).
 - (b) No unrelieved penetrations of the side walls shall be made. Enter through the forged heads if a pressure gage is needed.
 - (c) Provisions shall be made for visual inspection of the interior in accordance with 49 CFR (1995) for mobile storage units.
- (2) Gas tube trailers carrying more than one gas shall be prohibited unless logistical considerations absolutely mandate their use. Connecting fittings shall be keyed, sized, or otherwise configured so that it is physically impossible to cross-connect incompatible systems without malicious intent to do so (49 CFR 1995). GH₂ tube trailers shall be equipped with safety shutoff valves that are normally closed and require maintained power to open and remain open. The valves will automatically return to fully closed upon the removal

of the power. This is in addition to manually operated main shutoff valves. The valve cabinets shall be well ventilated.

Example: Findings concerning an explosion in a tube of a tube trailer that contained a mixture of hydrogen and oxygen showed that the accident occurred after a hydrogen tube trailer and an oxygen tube trailer were simultaneously connected to the same manifold. Insufficient barriers and incorrect purging procedures led to the damage of one shutoff valve and subsequent flow of higher pressure oxygen into one tube of the hydrogen trailer. Ignition was probably caused by contamination traveling through a valve at high velocity.

- (3) Common gas facilities for fuels and oxidants are not recommended. Such facilities require the approval of the AHJ at the controlling NASA center.
- (4) Fixed storage vessels shall be located in accordance with the approved quantity-distance tables in 29 CFR 1910.103 (1996) (see Section 405).

b. Fixed and Mobile Storage Systems for LH₂.

Containers for LH₂ storage, whether for nonpropellant or propellant use, shall be designed, constructed, and tested in accordance with appropriate requirements of the ASME BPVC (1995) or applicable provisions of API 620 (1990). Portable containers for LH₂ shall be designed, constructed, and tested in accordance with DOT specifications and regulations. Permanently installed containers shall be provided with substantial noncombustible supports securely anchored or firm noncombustible foundations. Steel supports in excess of 18 in. high shall be protected with a coating having a 2 h fire resistance rating (29 CFR 1910.103 1996, NFPA 50B 1994, and NMI 1710.3 1994).

- (1) LH₂ vessels should be designed to include thermal protection systems to minimize the evaporation losses. The types of insulation systems employed are the following:

501b

- (a) A vacuum equal to that required under operating conditions
 - (b) High vacuum plus powders such as perlite, silica aerogel, diatomaceous earth, fused alumina, and phenolic spheres
 - (c) Multiple layers of highly reflecting radiation shields separated by spacers or insulators plus a high vacuum
 - (d) Materials with low thermal conductivity (Hastelloy[®], titanium) used to support the insulation
- (2) The inner vessel should be designed to have a vapor tight seal in the outer jacket or covering to prevent air condensation and oxygen enrichment within the insulation. Condensed air in the insulation systems may explosively expand as it reverts to a gas when the LH₂ is emptied from the tanks or pipes.
- (3) Construction materials for surfaces exposed to a cryogen should retain the necessary mechanical properties and not tend toward low-temperature embrittlement (Chapter 3).
- (4) Fixed storage vessels for nonpropellant or propellant use shall be located in accordance with the appropriate QD tables in Section 405.
- (5) Pressure relief is required for the inner vessel and vacuum jacket (see Section 504). Appendix B, Example 4 examines pressure rise in storage vessels.
- (6) Bottom openings on LH₂ containers should be avoided where possible (preventing an uncontrollable leak path if a valve or connector should fail).
- (7) Safety techniques and devices include such special provisions as elimination of static electricity buildup, locking devices to prevent loosening of parts, flexible grounding straps from the compartment doors to the main vessel frame structure, and the protection of all fittings, valves, gauging devices, manifolding, etc., against damage caused by collision or overturning.

- (8) Recommended procedures, driver training, and basic operations shall be consistent with 29 CFR (1996) and 49 CFR (1995) (see Chapter 8).
- (9) All LH₂ vessels, stationary and mobile, should be equipped with remote control shut off valves, except manually operated valves may be used under the following conditions:
 - (a) The loading operations and valve are attended by two trained operators using the buddy system if approved by the AHJ at the controlling NASA center.
 - (b) The pressure of the vessel does not exceed the MAWP.
- (10) A mobile vessel used as a component of a test facility should have a remote-operating, fail-safe shut off valve. A manual override should be provided for use if the power fails.

c. Fixed and Mobile Storage Systems for SLH₂.

- (1) The design principles given above for LH₂ are directly applicable to the handling of SLH₂; however, the properties of SLH₂ call for additional considerations described below.
- (2) Cryogenic considerations.
 - (a) The use of SLH₂ requires greater care than when operating with NBP LH₂. The operating temperature of SLH₂ is lower than that for NBP LH₂, 13.80 K (-434.8 °F) versus 20.27 K (-423.2 °F). The vapor pressure of SLH₂ at its operating temperature is 7.04 kPa (1.02 psia); therefore, the container should be designed for operation at subatmospheric pressure. The heat of fusion (melting of the solid) for SLH₂ is 58.29 J/g (25.1 Btu/lb) compared with 445.6 J/g (191.7 Btu/lb) for vaporization of NBP LH₂.

501c

- (b) It is necessary that systems for SLH₂ ground storage and transfer be built with the lowest possible heat input (highest quality thermal insulation). Also provisions should be made for transferring the liquid-solid mixture to preclude any accumulation of solid particles that could block or plug valve seats, instrumentation ports, or relief valve openings.
 - (c) The tolerable amount of heat leak into SLH₂ storage dewars depends on actual sizes and logistics. Current technology for the construction of large-scale cryogenic storage dewars indicates that maintaining SLH₂ at a 50 percent mass fraction of solid would require a replenishment rate of SLH₂, 50 percent solid by mass of 0.5 percent per day. Without replenishment, the solid fraction would decrease by about 0.5 percent per day.
- (3) Storage and Upgrading.
- (a) A replenishment or upgrading process is needed to eliminate the possibility of a decrease in solid fraction and/or to upgrade the SLH₂ above the level at which it was originally transferred into the storage dewar. This can be accomplished by placing a filter at the outlet of the storage vessel leading to a return transfer line, that, with the fill line from the SLH₂ production unit, will allow for the continuous transfer of SLH₂ to the storage dewar with the triple-point liquid being returned to the slush generator. With proper attention to maintaining the ullage pressure, this technique can be used for replenishing or upgrading the SLH₂ in a flight vessel.
 - (b) A provision for stirring the SLH₂ in ground or flight storage vessels may be required to prevent the solid particles from settling or agglomerating. The stirring will also tend to destroy the thermal gradients that will require helium pressurization of the vessel to avoid subatmospheric pressures. The stirring may also be necessary to maintain a free passageway

through the solids that tend to accumulate at the filter entrance.

- (4) **Materials Selection.**
 - (a) From a structural standpoint, the proper selection of materials to be used can be assured by using only materials shown to be suitable for LH₂ service (see Chapter 3). The desirability of maintaining thermal gradients and the thermal conductivity of appropriate structural materials should be considered along with the strength-to-weight ratios, thermal expansion coefficients, and low-temperature ductilities.
 - (b) Although the temperature differences between LH₂ and SLH₂ should not cause any problems when using materials suitable for LH₂ service, the possibility remains that the solid particles flowing in SLH₂ could, over time, cause the softer materials to erode in certain places, such as in a valve seat.

- (5) **Subatmospheric Pressure Considerations.** Although efforts are made to avoid storing and handling the SLH₂ at subatmospheric pressures, the possibility of pressure collapse is always present. Negative pressures will occur if the evaporative-cooling production method is used. Additional safety precautions should be taken to preclude contamination and enhance the operational safety of the system.
 - (a) Systems for handling SLH₂ should be designed to make the maximum use of welded construction as a primary requirement. Demountable joints should be used only where absolutely necessary.
 - (b) State-of-the-art leak detection techniques are to be used in fabricating all of the equipment in which SLH₂ is to be handled. A leak detection test should be performed after thermal cycling from ambient temperature down to at least 77 K (-320 °F) (LN₂ temperature).

501c

- (c) SLH₂ handling equipment shall be continuously monitored for the intrusion of air from the atmosphere after placing the equipment into service. Samples of SLH₂ taken from the stored fluid are warmed to room temperature and subjected to gas analysis: mass spectrometry or gas chromatography. This technique has the disadvantage of having to determine how closely a given sample represents the contents of the entire stored volume (Daney and Mann 1966).

- (d) Guard Volumes.
 - 1 Instrumentation tubes, flanges, wire pass-throughs, and valve stem packings compromise, to some extent, the integrity of the otherwise more robust and impenetrable, all-welded construction of an SLH₂ system.

 - 2 The SLH₂ system design should maximize the use of external volumes, under a high vacuum or containing a noncondensable inert gas (helium), surrounding the portions of the system at (or potentially at) subatmospheric pressure. The vacuum in the guard volume shall be monitored and provided with an alarm to warn of the loss of vacuum when vacuum is used. the pressure of helium in the guard volume shall be maintained and monitored if protection against air intrusion is by means of an exterior surrounding space, sealed from the atmosphere and pressurized with helium gas at a pressure above that of the atmosphere. Vacuum pump systems and discharge points of pressure-relief valves and rupture disks deserve special attention.

- (6) Fluid Quantity Measurements. It is not difficult to determine the total volume of SLH₂ by using liquid level measurements; however, this procedure does not determine the mass. The level of the solid fraction can

be measured when settling is allowed to take place in the SLH₂ system. Without a greater knowledge of the degree of packing of the solid, the total mass of the stored SLH₂ will still be unknown. Nuclear radiation attenuation or other means whereby the mass concentration of a representative sample can be measured should be considered and the results assumed to be valid for the entire contents of the vessel.

- (7) Thermal Acoustic Oscillations. Thermal acoustic oscillations and their propagation are a periodic source of elevated pressure and can pump large quantities of energy into the main storage volume. Designing SLH₂ systems with favorable aspect ratios and surge volumes is a promising method for reducing this problem.
- (8) Instrumentation.
 - (a) The distribution of solid particles within the liquid is very difficult to determine, and it changes during production, storage, aging, stirring, and transfer. At present, the contents of a containment vessel needs to be observed to determine production, storage, aging, and other critical characteristics of the SLH₂.
 - (b) A number of designs for visual observation ports have been reported and generally are composed of two or three quartz, glass, or sapphire windows separated by high-vacuum as thermal insulation.
- (9) At present, the difficulties in handling and maintaining SLH₂ mixtures make it unlikely that SLH₂ would be produced at a remote location and transported to the use site. Thus, transporting SLH₂ for significant distances is not considered, and discussion of mobile storage systems for SLH₂ is not presented.

d. Aerospace Pressure Vessels.

NSS/HP 1740.1 (1974) and NSS/HP 1740.4 (1976) include standards providing criteria for using fracture control techniques to design, fabricate, test and operate aerospace pressure vessels. When technically possible, each pressure vessel should be designed to

501d

accommodate proof and verification. Tests should be performed to confirm the design, manufacturing processes, and service life. Qualification tests should be conducted on flight-quality hardware. All aerospace pressure vessels should be subjected to an acceptance test. Pressure vessels for use in flight or ground support equipment may be designed to MIL-STD-1522A (1984) or equivalent.

e. Supports.

- (1) The design of vessel support members should account for all concurrently acting loads transmitted into such supports. These loads, in addition to weight effects, should include loads introduced by service pressure and temperature, vibration, wind, earthquake, shock, and conditions such as thermal expansion and contraction.
- (2) The design and construction of supports for inner vessels systems should be optimized with respect to structural and thermal operational requirements.

502 PIPING SYSTEMS.

The design of a piping system for hydrogen use shall consider the pressure, temperature, and various forces applicable to the design of a hydrogen piping system. Special consideration shall be given for the unique properties of hydrogen, such as hydrogen embrittlement. Piping systems for hydrogen use shall be designed based on the most severe condition of coincident pressure, temperature, and loading. The most severe condition shall be the one that results in the greatest required pipe thickness and highest flange rating. Piping as used in this guideline includes pipe, tubing, flanges, bolting, gaskets, valves, relief devices, fittings, and the pressure containing portions of other piping components. It also includes hangers and supports and other equipment items necessary to prevent overstressing pressure containing components.

a. General.

Piping systems include all hydrogen transmission lines and associated components including the lines and fittings connecting test articles to hydrogen supplies. Safety reviews of piping systems designs shall be in accordance with those detailed in Sections 400 and 401.

- (1) Piping materials and designs should be in accordance with ANSI/ASME B31.1 (1995) and ANSI/ASME B31.3 (1996). ANSI/ASME B31.1 (1995) and B31.3 (1996) generally do not

specify specific materials to be used in piping systems; but provide guidance and limitations on the selection of some materials acceptable for use in piping systems. These Codes provide some useful properties, such as minimum temperature and maximum allowable stress values as a function of operating temperature for these materials (Table A5.3). GH₂ systems should also conform to the special requirements of NFPA 50A (1994) and LH₂ systems to NFPA 50B (1994).

- (2) Chapter 3 discusses general materials recommended for use in hydrogen piping and system components.
- (3) Piping and pressure containing components shall be proof tested (ANSI/ASME B31.3 1996). Additional testing may be included as required; such as pneumatic flow testing at operating conditions and cold testing.
- (4) Facility and transfer piping systems shall include safeguards in accordance with ANSI/ASME B31.3 (1996) for protection from accidental damage and for the protection of people and property against harmful consequences of vessel, piping, and equipment failures. Barriers should be considered for operator protection particularly from metal parts associated with pump failures. Within a process area, hydrogen transport piping shall be treated similar to hydrogen storage in that all such piping shall be isolated by an exclusion zone in which access is restricted and certain types of operations are prohibited while hydrogen is present in the piping system (see Section 405a.(3)).
- (5) New piping for GH₂ or LH₂ shall not be buried. Piping shall be placed in open trenches with removable grating if placed below ground.
- (6) Existing, buried GH₂ piping shall be operated in accordance with the conditions of retroactivity detailed in Section 101g.
- (7) All piping shall be periodically tested as part of the recertification of the pressure system (Section 411).
- (8) The piping and components shall be tagged and coded as described in Section 409.
- (9) Hydrogen lines should not be located beneath electric power transmission lines. Electric wiring systems permitted above hydrogen lines should comply with the appropriate code (NFPA 50B 1994).

- (10) The metal components of a hydrogen system shall be electrically bonded in accordance with NFPA 70 (1993). This includes tanks, regulators, valves, pipes, vents, vaporizers, and receivers (mobile or stationary). Sufficient grounding connections should be provided to prevent any measurable static charge from accumulating on any component. Each flange should have bonding straps in addition to metal fasteners, which are primarily structural.
- (11) Joints in piping and tubing should be made by welding or brazing. Mechanical joints, such as flanges, should only be used for ease of installation and maintenance and other similar considerations.
- (12) Provisions shall be made for the expansion and contraction of piping connected to a pressure vessel to limit forces and moments transmitted to the pressure vessel, by providing substantial anchorage at suitable points, so there shall be no undue strain to the pressure vessel.

b. Supports.

- (1) The design of piping support members should account for all concurrently acting loads transmitted into such supports. These loads, in addition to weight effects, should include loads introduced by conditions such as service pressure and temperature, vibration, wind, earthquake, shock, and thermal expansion and contraction.
- (2) All supports and restraints should be fabricated from materials suitable for the service conditions. Any attachments welded to the piping should be of material compatible with the piping and service conditions. The stress for the base material of all parts of supporting and restraint assemblies should not exceed the allowable stress at the operating temperature for the part in question.
- (3) Pipe supports for thin wall vacuum jacketed pipe should be located at points on the jacket with doubler plates or load-spreading saddles.
- (4) The design and construction of supports for inner piping systems should be optimized with respect to structural and thermal operational requirements.

c. Piping for GH₂.

- (1) Materials for GH₂ piping systems and components must be suitable for the stress, temperature, pressure, and exposure conditions.
- (2) Conditions considered to characterize hydrogen embrittlement failures include temperature, pressure, and hydrogen purity. Failures of piping and components are most severe at room temperature, at high pressure, and with very pure hydrogen. (The problems are reduced at cryogenic temperatures.)
- (3) High-pressure gas manifolds are to be constructed of suitable materials (Chapter 3) and of welded construction wherever possible. Expansion or contraction should be accommodated, and adequate supports should be provided.

d. Piping for LH₂ and SLH₂.

- (1) Most LH₂ or SLH₂ lines are vacuum jacketed or insulated to reduce heat input and prevent the condensation of atmospheric air. The piping vacuum jacket systems should be separate from the vacuum systems of the main hydrogen storage and handling systems. The jacket design should consider the thermal flexibility of the inner line and allow the jacket to follow its natural thermal displacement. The vacuum jacket shall have its own separate pressure-relief system. Appendix B, Example 5 examines the effect of insulation for LH₂ lines on the heat leak rate.
- (2) Bellows expansion joints usually are placed in the outer jacket when they are used. Expansion joints may be used in the inner line, but their placement will affect the thermal stress forces transmitted to the outer jacket and add potential vacuum leak sources. Bellows should not be extended or compressed at installation to make up deficiencies in length or for proper alignment. The inner pipe usually is supported within the vacuum jacket by spacers in the annulus. The spacer design and location should take into account the thermal loading during cool down and forces transmitted to the jacket. The spacers should also support the dead weight of the inner line under all imposed conditions. Piping systems must have sufficient flexibility to prevent thermal expansion or contraction causing piping failures or leaks. Expansion loops or Invar[®] piping are alternatives to expansion joints.

- (3) An LH₂ or SLH₂ system built of stainless steel has a thermal contraction of about 0.3 percent from ambient temperature to 20 K (-423 °F). Long runs of piping require a support at intervals to allow for axial motion with lateral and vertical motion restrained.
- (4) Expansion joints used in vacuum jacket systems normally have the lowest pressure rating in the vacuum system and should be marked to indicate pressure rating and direction of flow. Swivel joints and connections that allow for three degrees of freedom should be installed in piping exposed to differential movements, such as ship-to-dock piping.
- (5) Piping systems must have sufficient flexibility to prevent excessive stresses caused by thermal expansion, contraction, or movements of piping supports and terminals. Consideration should be given to the following:
 - (a) Failure of piping, supports, or anchors from overstress or fatigue
 - (b) Leakage at joints
 - (c) Detrimental stresses or distortion in piping or in connected equipment resulting from excessive thrusts and moments in the piping
 - (d) Resonance with imposed or flow-induced vibrations
 - (e) Cryogenic bowing in horizontal pipe lines because of the stratified flow of a single liquid layer on the bottom of the pipe; Consideration shall be given to the large forces normally generated by bowing in designing pipe guides and main and intermediate anchors for bellows expansion joints. Cryogenic pipe lines should be operated in regimes in which stratified flow does not occur.
- (6) Each section of cryogenic piping in which liquid lockup is possible shall be equipped with protective devices to control overpressures, particularly those caused by insulation failures and fires. Appendix B, Example 3 examines pressure rise caused by liquid lockup in a line.

- (7) Insulation for LH₂ or SLH₂ piping shall have a self-extinguishing fire rating. Other fluid lines should also be protected from freezing because of proximity to the LH₂ or SLH₂ lines; a thermostatically controlled heater should be considered to provide protection. Cryogenic piping systems should not be painted white. Frost is the best indicator of insulation failure.
- (8) Low points (traps) on liquid discharge piping are to be avoided to prevent the accumulation of contaminants and trapping of liquid. Low-point drains should be provided if traps are unavoidable.
- (9) Any uninsulated piping and equipment operating at LH₂ or SLH₂ temperatures shall be installed away from (and not above) asphalt or other combustible surfaces and protection provided for incompatible metals subject to cold embrittlement.
- (10) SLH₂ transfer lines should be designed to eliminate possible flow segregation and settling or filtering of the solid hydrogen particles.
- (11) Piping and piping components shall be designed for at least the MAWP of the hydrogen supply or the MAWP is the pump output pressure when such systems are supplied by pump.

e. Bending and Forming Piping.

- (1) Pipe may be bent to any radius that will result in arc surfaces free of cracks and substantially free of buckles. Flattening of a bend, as measured by the difference between the maximum and minimum diameters at any cross section, should not exceed 8 percent of the nominal outside diameter for internal pressure and 3 percent for external pressure.
- (2) Piping components may be formed by any suitable hot or cold working method (swaging, lapping, or upsetting of pipe ends, extrusion of necks, etc.), provided such processes result in formed surfaces that are uniform and free of cracks or other defects.
- (3) The various piping components should be assembled, in a shop or as a field erection, so the completely erected piping conforms with the specified requirements of the engineering design.

- (4) Any compound or lubricant used in threaded joints shall be suitable for the service conditions and shall not react unfavorably with hydrogen or the piping materials. Threaded joints to be seal welded shall be made up without any thread compound.

f. Double Block and Bleed.

Consideration should be given to using the double block and bleed arrangement to isolate supplies from other parts of the system when designing hydrogen systems.

503 COMPONENTS

a. Joints, Connections, Fittings, and Flanges.

(1) Joints.

(a) Joints In Piping and Tubing.

- 1 Joints in piping and tubing may be made for GH_2 by welding or brazing or using flanged, threaded, socket, or compression fittings. Joints in piping and tubing for LH_2 or SLH_2 preferably shall be made by welding or brazing; flanged, threaded, socket, or suitable compression fittings may be used. Brazing materials shall have a melting point above 811 K (1000 °F) (NFPA 50A 1994 and NFPA 50B 1994).
- 2 The fused joint is recommended in GH_2 , LH_2 or SLH_2 systems because of its simplicity and high reliability. Hard soldering and welding often can meet the bonding requirements, but the welded joint takes preference for safety (CFR 29 1910.103). This is a potential safety factor because a melted joint could release additional large quantities of fuel in the event of an accidental fire. Such failures could develop into a chain reaction in large systems. All general purpose GH_2 , LH_2 , or SLH_2 systems should be constructed of high melting point materials for this reason.

(b) Welded Joints.

- 1 Welding is the first preference for all hydrogen systems, and all forms of welding can be used (ANSI/ASME B31.1 1995 and ANSI B31.3 1996, as supplemented by a NASA center document). The type of weld to be used generally is determined by factors other than the system is for hydrogen use. Gas tungsten arc (heliarc[®]) welding generally is preferred for joining light-gauge stainless steel and often is preferred for construction of vacuum-jacketed equipment. Conventional arc techniques also are used extensively, especially for heavy-gauge material for which cost is a strong factor. Filler material and stress-relieving requirements are determined by the parent material to be joined, and normal standard practices should be followed.
- 2 To identify individual welds, mark with crayon or paint not conducive to corrosion of the base metal, unless another method is specified by the engineering design. No markings shall be allowed on the inner pipe of vacuum-jacketed joints to preclude out-gassing. Welds, including additions of weld metal for alignment, shall be made in accordance with a qualified procedure and by qualified welders or welding operators.
- 3 NASA is responsible for the welding done by NASA personnel and shall conduct the required tests to qualify the welding procedures and the welders or welding operators. Contractors are responsible for welding done by their personnel. An employer shall not accept a performance qualification made by a welder or welding operator for another employer without the inspector's specific approval. If approval is given, acceptance is limited to performance qualification on piping using the same or equivalent procedure wherein the essential variables are within the limits set forth in ASME BPVC (1995) Section IX, except as modified in ANSI/ASME B31.1 1995 and ANSI/ASME B31.3 (1996).

- (c) Threaded Joints. Threaded joints with a suitable thread seal are acceptable for use in GH₂ systems but are to be avoided in LH₂ or SLH₂ systems. Consideration should be given to back-welding threaded joints inside buildings for GH₂. Bayonet joints should be used for LH₂ or SLH₂ transfer operations.
- (d) Mitered Joints. Mitered joints may be used in LH₂ or SLH₂ piping systems under the following conditions:
- 1 A joint stress analysis has been performed and the appropriate safety committee has approved.
 - 2 The number of full-pressure or thermal cycles will not exceed 7000 during the expected lifetime of the pipe system.
 - 3 Full-penetration welds should be used in joining miter segments.
- (e) Quick-Connecting Flange Joints. Quick-connecting flange joints are recommended for connecting loading arms from ships to storage to ensure minimum times for making or braking connections, increasing safety in an emergency. Docking and unloading facilities should be designed for possible impact loads, protection from LH₂ or SLH₂ spills, and rapid deberthing of ships. Pier loading facilities shall be located at least 300 m (1000 ft) from bridges. Effort should be maintained to keep the ship-to-shore recirculation loops cold so heat leakage is reduced, geysering is minimized, and problems related to warm vapor returning to the tanks are eliminated.
- (f) Silver Braze Joints. No unique problems have been encountered with silver braze materials. The choice of braze composition is determined by ease of application to the material to be joined; however, cadmium containing silver brazes shall not be used (29 CFR 1910.1027 1996). Silver brazes are recommended for joining copper-base materials and dissimilar metals such as copper and stainless steel. The melting point must be greater than 811 K (1000 °F) (NFPA 50A 1994 and NFPA 50B 1994).

- (g) **Soft Solder Joints.** Soft solder joints are not permissible in hydrogen systems. Soft solder has a low melting point and will quickly fail in fire, potentially releasing more hydrogen. Also, soft solders containing tin may become crumbly and lose all strength at cryogenic temperatures (CFR 29 1910.103). Soft solder may be used as appropriate in nonhydrogen portions of the system such as a vacuum jacket.
 - (h) **Bimetallic Transition Joints.** Bimetallic transition joints should only be used as necessary. Emphasis of the design should be to reduce stress on the joint.
- (2) A pipe having a branch connection is weakened by the opening made in it, and it requires reinforcing unless the pipe wall is sufficiently thicker than required to sustain the pressure. Greater flexibility should be provided in the smaller line, of designs of small branches out of large and heavy runs, to accommodate thermal expansion and other movements of the larger line. Branch connections should be made in piping systems as follows:
- (a) Fittings (tees, laterals, and crosses) should be made in accordance with standard procedures.
 - (b) Outlet fittings should be welded.
 - (c) The branch pipe may be welded directly to the run pipe with or without reinforcement.
 - (d) Extruded outlets in the run pipe, at the attachment of the branch pipe, should be butt welded.
- (3) Tube fittings of flared, flareless, or compression type may be used for tube sizes not exceeding 5.1 cm (2 in.) outside diameter within the limitations of applicable standards. The designer shall determine that the type and the material of the fitting selected is adequate and safe for the design conditions in the absence of standards, specifications, or allowable stress values for the material used to manufacture the fitting (ANSI/ASME B31.1 1995).
- (4) Flanges should be designed and manufactured in accordance with the ASME BPVC (1995). Blanks to be used for test purposes only should be designed in accordance with the

ASME BPVC (1995), except the design pressure should be at least equal to the test pressure and the allowable stress should be as great as 90 percent of the specified minimum yield strength of the blank material. Flanges using a soft gasket should use a raised-face flange with a concentrically serrated face.

(5) Flexible Hoses.

- (a) Flexible hoses pressurized to greater than 1.14 MPa (165 psia) should be restrained at intervals not to exceed 1.83 m (6 ft) and should have an approved restraint device such as the Kellems hose containment grips attached across each union or hose splice and at each end of the hose. The restraint devices should be secured to an object of adequate strength to restrain the hose if it breaks.
- (b) Hose containment methods and devices that differ from standard devices should be approved by the AHJ at the controlling NASA center. Hose containment methods and devices are described in NASA center documents such as KHB-1710.2.
- (c) Flexible hoses carrying LH₂ or SLH₂ should be vacuum jacketed. The inner flexible hose should be the load-carrying member.

(6) Expansion Joints.

- (a) Bellows expansion joints used in hydrogen piping systems may be convoluted or toroidal and may or may not be reinforced. Lap-welded tubing should not be used.
- (b) A fatigue life able to withstand the full thermal motion cycles should be a design requirement, but the life of the bellows should not be less than 1000 full thermal movement and pressure cycles in any case (ANSI/ASME B31.3 1996).
- (c) Expansion joints should be marked to show the direction of flow. Unless otherwise stated in the design specifications, flow liners should be provided when flow velocities exceed the following values:

- 1 Expansion joint diameter less than or equal to 15.2 cm (6 in.), gas flow velocity of 48 m/s per meter of tube diameter (4 ft/s per inch of tube diameter) or liquid flow velocity of 24 m/s per meter of tube diameter (2 ft/s per inch of tube diameter).
- 2 Expansion joint diameter greater than 15.2 cm (6 in.), gas flow velocity of 300 m/s per meter of tube diameter (25 ft/s per inch of tube diameter) or liquid flow velocity of 120 m/s per meter of tube diameter (10 ft/s per inch of tube diameter).
- (d) The hydrostatic end force caused by pressure as well as the bellows spring force and the guide friction force shall be resisted by rigid external anchors or a tie rod configuration in all piping systems containing bellows.
- (e) The expansion joints should be installed in locations accessible for scheduled inspection.
- (f) Pressure tests of piping systems should be performed with the bellows expansion joints installed in the line with no additional restraints so the expansion joint cross connections or external main anchors carry the full pressure load. Tests should not be performed until all anchors and guides are securely in place.
- (g) The quality of the expansion joint can be ensured by any or all of the following means, as specified by the systems engineer. As a minimum, tests 1 and 2 should be performed.
- 1 One-hundred percent dye penetrant inspection of the outside surface of the bellows tube weld before forming
- 2 One-hundred percent x-ray inspection of the bellows tube weld before forming
- 3 One-hundred percent dye penetrant inspection of the outside surface of the bellows tube weld after corrugating
- 4 One-hundred percent dye penetrant inspection of all pressure-retaining attachment welds

- 5 Soap-bubble leak test (air under water or helium mass spectrometer)
 - 6 Hydrostatic testing at 1.5 times design pressure
- (h) The stability of the bellows element in the expansion joint shall be demonstrated by conducting a standard manufacturer's hydrostatic test of 1.5 times design pressure on at least the first item of each design.
- (i) When a large pressure gradient exists in a line such as a flare stack line or a vertical line and the pressure gradient is largely because of elevation (as with storage tanks, etc.), the bellows load may be additionally restrained or the bellows may be blocked off or removed. Another system test should be conducted at 1.5 times the bellows operating pressure to demonstrate adequacy of the anchors.
- (j) Multi-ply expansion joints and bellows should not be used in cryogenic service.
- (7) V-Band Couplings.
- (a) Properly applied V-band couplings are approved for connecting vacuum-jacketed LH₂ or SLH₂ lines. Suppliers offer a wide selection of couplings that range from light to heavy duty and cover a number of flange angles and thicknesses. Visual inspection often is not adequate to distinguish between some of the similar types. It is mandatory to use part numbers to ensure proper application of the couplings.
- (b) Male and female flanges should mate properly before applicable V-band couplings are applied. The couplings are not expected to correct any misalignment inherent in fabrication or make a leak-free joint where flanges or O-rings have been damaged.
- (c) Extreme care should be exercised in applying and tightening the couplings to ensure a leak-free joint.
- (d) Vacuum-jacketed piping must not be subjected to excessive tension forces. Flexible sections often are employed; however, to be effective, the sections should be connected with sufficient slack (or

compression) when warm so they will not be excessively stretched as the system is cooled to the operating temperature.

(8) Valves.

- (a) Valves subjected to cold hydrogen flows shall be suitable for cryogenic service.
- (b) A shut off valve shall be located in liquid product withdrawal lines as close to the container as practical. On containers of over 7.6 m³ (2000 gal) capacity, the shutoff valve shall be a remote control type with no connections, flanges, or other appurtenances (other than a welded manual shutoff valve) allowed in the piping between the shutoff valve and its connection to the inner container (29 CFR 1910.103 1996).
- (c) Vessels used as components of a test facility should have remote operating fail-safe shutoff valves. A manual override must be provided for use if the power fails.
- (d) Excess flow valves for GH₂ service are self-actuated devices that shut off flow when the built-in sensing mechanism detects that a preset maximum flow rate has been reached. The excess flow valve may be used to provide an immediate hydrogen shut off in the event of failure of the piping system or equipment.
- (e) Rupture disks or relief valves must be installed in all enclosures that contain liquid or can trap liquids or cold vapors for protection against the hazards associated with ruptures. Rupture disks or relief valves may not be necessary if the liquid or the cold vapor trapped between two valves can be relieved through one of the valves at a pressure less than the design operating pressure.

(9) Transfer Connections.

- (a) Connections must be keyed, sized, or located so they cannot be cross connected to minimize the possibility of connecting incompatible gaseous fluids or pressure levels. The connections and fittings to be disconnected

503a

during operations should be provided with tethered end plates, caps, plugs, or covers to protect the system from contamination or damage when not in use.

Pressure relief shall also be provided if cold fluid can remain trapped in the lines.

(b) GH₂ Transfer Connections.

1 GH₂ connections from over-the-road tube trailers or supply systems should conform to the specific safety design and material requirements. The cylinder pressure should not be allowed to fall below 172 kPa gage (25 psig) to prevent the infiltration of air into the gas cylinders.

2 Piping, tubing, and fittings must be suitable for hydrogen service at the pressures and temperatures involved. The joints in piping and tubing preferably should be made by welding. Provisions must be made for expansion and contraction.

3 Flexure installations to be used at high pressures must be designed so restraint is provided on the hose and adjacent structure. The restraints must be provided at 1.83 m (6 ft) intervals and at each end to prevent whiplash in the event of a rupture.

(c) LH₂ and SLH₂ Transfer Connections.

1 Vessels should be connected to rigidly mounted test facility piping with supported and anchored flexible metal hose insulated for low-temperature services at the desired pressure. Recommendations for flexible hoses include a maximum allowable slack of about 5 percent of the total length. The hose restraints should be at least 50 percent stronger than the calculated impact force on an open line moving through the flexure distance of the restraint for greater safety. Sharp bends and twists should be avoided in the routing of flexible hose. A minimum of five times the outside diameter of

the hose is considered acceptable as a bend radius.

- 2 Each end of the LH₂ discharge hose should be equipped with male bayonet couplings capable of connecting to a female connector coupling of the U.S. Air Force bayonet assembly, or as approved in NASA center documents such as KHB 1710.2 (1983). The fasteners for the couplings may be bolted flange, spanner nut, or V-band fasteners designed for the required operating pressure.
- 3 Quick-connecting flange joints are recommended for connecting loading arms, especially from ships to storage. Being able to make or break connections quickly provides greater safety in an emergency.
- 4 The mobile supply should be located to provide safe access, but the flange to flange distance of the flexible hose should not be greater than 3 m (10 ft) (CGA V-6 1993). The pressure range of the transfer equipment must be rated equal to or greater than the tanker design pressure.
- 5 If condensation or frost appears on the external surface of the hose during use, the hose should be taken out of service until the vacuum has been restored.

b. Gaskets and O-Rings

(1) General.

- (a) The selection of a gasket for obtaining a leakproof joint depends on the mechanical features of the assembly, system operating conditions, fluid characteristics, and gasket material characteristics and design. The general characteristics are interdependent, and a change of one condition can alter the choice of gasket.
- (b) Even with proper assembly and design and sound installation, subtle changes because of fatigue,

503b

temperature changes, and vibration may reduce gasket material resilience and cause a leak. Torque loss becomes a serious consideration and requires a gasket material that will be minimally affected by thermal gradients.

- (c) The contact surface finish of the assembly face and the type of assembly affect gasket selection. The bolting should be adequate to produce the degree of gasket flow required for a pressure-tight seal. A relatively rough surface finish requires heavier bolting to achieve the requisite gasket flow than a smooth surface finish. Concentrically serrated faces are preferred.
 - (d) Flanges should be leak checked periodically. Flanges with soft gaskets in LH₂ and SLH₂ systems should be retorqued periodically.
- (2) Metal O-Rings.
- (a) Metal O-rings have proven satisfactory for sealing flanges on LH₂ piping and vessels only when coated with a soft material and used on smooth surfaces.
 - (b) Type 321 stainless steel O-rings with a coating such as Teflon[®] or silver should be used in stainless flanges with stainless bolts.
 - (c) Likewise, Teflon[®]-coated aluminum O-rings should be used in aluminum flanges with aluminum bolting. Using similar materials avoids the leakage possibility from unequal contraction or corrosion of dissimilar metals.
 - (d) Surface finishes in the O-ring groove and contact area should be in accordance with the manufacturer's specifications. All machine or grind marks should be concentric.
- (3) Gaskets, Seals, and Valve Seats.
- (a) Kel-F[®] (polytrifluorochloroethylene) or Teflon[®] (polytetrafluoroethylene) can be used in LH₂ or SLH₂ systems for the following sealing applications:

- 1 Valve seats may be Kel-F[®] or modified Teflon[®] (Fluorogreen[®] is preferred).
 - 2 Gland packing or seal only if it is maintained near ambient temperatures as in an extended bonnet of a shutoff valve. The contraction or shrinkage of Teflon[®] when cooled from ambient to cryogenic temperatures allows leakage.
- (b) Correct installation of a gasket is of major importance if subsequent leaks are to be averted. Flange faces should be clean and as closely aligned as possible. The gasket should be centered. The bolts should be tightened by hand then two bolts, 180° apart, should be tightened. The operation should be repeated until all bolts are uniformly torqued. The amount of torque applied at each step during tightening should be small at the start to avoid cocking the flange faces. It may be necessary in LH₂ or SLH₂ applications to retighten bolts to compensate for thermal forces. Means to prevent bolts from loosening should be provided.
- (c) A raised-face flange is recommended for high pressures or low temperatures. Metallic gaskets have been used successfully with raised-face flanges for pressures to 20.6 MPa (3000 psig). A tongue-and-groove flange is desirable for most gasket materials for higher pressures. A confining flange is mandatory if a plastic such as Teflon[®] is used. Twenty-five percent glass-filled Teflon[®] (Fluorogreen[®] or Fluorogold[®]) should be used for flanges that are not seal welded.
- (d) Flat, thin gaskets for tongue-and-groove flanges, where the gasket is shrouded on four sides. Virgin Teflon[®] gaskets should be captured on all sides to prevent cold flow and subsequent leakage.
- (e) Care should be taken to accommodate the cold flow characteristics of the material for raised-faced, separated flanges using 25 percent glass-filled Teflon[®] or other, similar soft gaskets. Retorque flanges a minimum of 30 h after initial torque, after each cryogenic use until torque relaxation has ceased, and on an annual basis.

503b

504 OVERPRESSURE PROTECTION OF STORAGE VESSELS AND PIPING SYSTEMS

a. General.

Safety devices shall be installed on tanks, lines, and component systems to prevent damage by overpressure. The required relieving capacity of any pressure-relief device should include consideration of all the vessel and piping systems it protects (29 CFR 1910.103 1996, CGA S-1.1 1995, CGA S-1.2 1995, and CGA S-1.3 1995). Appendix E contains additional information.

b. Safety Valves.

Safety valves should be designed so the movable parts cannot stick or seize even with unequal heating or cooling. Packings that might hinder the working of the safety valve through friction should not be used.

- (1) The design of the safety valve installation requires careful attention to be paid to all loads acting on the system. All components in the safety valve installation should be given consideration, including the complete piping system, connection to the main header, safety valve, valve and pipe flanges, downstream discharge or vent piping, and system support.
- (2) The relief or safety valves shall be set to limit the maximum pressure to not exceed the MAWP.
- (3) Safety and relief valves should be direct spring or deadweight loaded, except pilot valve control or other indirect operation of safety valves is allowed if the design is such that the main unloading valve automatically opens at the set pressure or less and is capable of discharge at its full rate capacity if the pilot or auxiliary device should fail.
- (4) Relief valves shall be sized to accommodate the maximum flow capacity of the pressure source.
- (5) All materials used in the construction of overpressure protection systems, including the pressure-relief devices, should be suitable for the operating temperature of the tankage and piping systems. Pressure-relief devices and the inlet and discharge piping should be designed and installed to minimize moisture accumulation and ice buildup from atmospheric condensation, that could cause them to fail to function

properly. The pressure-relief devices preferably should be located to relieve vapor-gas rather than liquid.

- (6) The openings through all pipe fittings between a piping and tankage system and its pressure-relief device should have at least the area of the device inlet. The flow characteristics of the upstream system should be such that the pressure drop will not reduce the relief capacity below that required or adversely affect the proper operation of the pressure-relief device. The pressure drop should not exceed 5 percent of the set pressure.
- (7) Pressure-relief devices discharge vents should not be connected to a common line when feasible. The effect of the back pressure that may develop when valves operate should be considered when discharge lines are long or outlets of two or more valves having different relief set pressures are connected to a common line. Discharges directly to the atmosphere should not impinge on other piping or equipment and should be directed away from platforms and other areas used by personnel because the discharge gas may ignite and burn. Reactions on the piping system because of actuation of pressure-relief devices should be considered, and adequate strength should be provided to withstand the reactions.
- (8) Stop valves should not be installed between the tankage and piping being protected and their protective devices or between the protective devices and the point of discharge without approval of the AHJ at the controlling NASA center. Stop valves may be installed in other areas under specific conditions. An authorized person should continuously observe the operating pressure and should have an arrangement for relieving the system in the event of overpressure if stop valves are to be closed while the equipment is in operation. Also, stop valves may be used in pressure-relief piping if they are constructed or positively controlled so closing the maximum possible number of stop valves will not lower the capacity of the unaffected pressure-relief devices below that required.
- (9) A rupture disk or relief valve shall be installed in every section of a line where liquid or cold gas can be trapped. This condition exists most often between two valves in series. A rupture disk or relief valve may not be required if at least one of the valves will, by its design, relieve safely at a pressure less than the design pressure of the liquid line. This procedure is most appropriate in situations where rupturing of the disk could create a serious hazard.

504b

- (10) The installation design shall include a study of the discharge piping and pipe supports. Reactive force can be imposed on the valve or outlet piping and transmitted to the valve inlet and associated piping. This force could cause extensive damage if the discharge piping is unsupported. Also to be evaluated are the effects of sudden chill down stresses and thermal contractions that may result from the opening of a protective device. Appendix B, Example 7 is an example of the analysis of a pressure-relief valve.

c. Rupture Disks.

- (1) Rupture disks are designed to break at a specific pressure and temperature and tensile strength of the disk; therefore, the pressure at which a disk will rupture is directly affected by the temperature. The disks should be located to limit temperature variations. Rupture disks are susceptible to failure from cyclic loading. Rupture disks have finite lifetimes and routine replacement should be planned.
- (2) It is recommended that the stamped bursting pressure of rupture disks be sufficiently above the intended operating pressure to prevent premature failure of the rupture disks when they are used because of fatigue or creep. Rupture disks may be used in tandem or series with relief or safety valves and may be located upstream or downstream of the valves, provided the system design allows it. Rupture disks should be kept properly aligned.
- (3) Only materials suitable for the working conditions are to be used for rupture disks. Rupture disks should be rated as specified in Appendix E.
- (4) The response pressures of rupture disks at room temperature should be determined when testing, in addition to checking their dimensions. Rupture disks should be provided with a protective device to catch broken fragments of the bursting element and should be arranged to be protected against damage from outside.
- (5) The rupture disks may be installed upstream of the relief valve if the disk rupture pressure is less than the MAWP, methods of detecting disk failure or leakage are present, sizing is correct, and there is no chance for the disk failure to interfere with the operation of the relief valve.

- (6) Under approved conditions, rupture disks may be installed downstream of relief valves to prevent mixing of the atmosphere and the escaping hydrogen in the event of a temporary low-flow overpressure condition or to prevent ice from building up in the relief device. The rupture pressure under such conditions should not exceed 20 percent of the set pressure of the relief device and the space between the relief valve and the disk should be vented to a system in which back pressure will not adversely affect the operation of the relief valve.
- (7) A rupture disk may be installed in parallel with a second type of relief device of which the relief valve usually is set to relieve before the rupture disk.
- (8) Weather protection of the vent opening from the relief devices should be included.

d. Supplemental Pressure Relief.

- (1) Supplemental pressure-relief devices should be installed to protect against excessive pressures created by exposure to fire or other unexpected sources of external heat. Relief devices installed in any section of the vessel and piping systems limit the allowable working pressure. The special secondary relief valves, set at 110 percent of the MAWP, should be provided wherever it is possible to trap liquid in an appreciable fraction of the line volume. The supplemental relief device should be capable of limiting the pressure to 90 percent of the test pressure.
- (2) Transient pressure surges associated with chill-down flow instabilities, water hammer, and cavitation should be considered in designing and installing supplemental relief systems.

e. Failure Modes.

Failure modes that must be considered in the design and operation of protective pressure-relief systems include the following:

- (1) Pressure buildup associated with the phase change or temperature rise caused by the normal heat leak into the section. The minimum capacity of the primary protective device should be determined by the heat leak rate. The device should be located as near as possible to the highest point in the line section (Appendix B, Example 3).
- (2) The overpressure potential associated with connection to a high-pressure source of any type - pump, pressure-relief valve, or direct connection through a flow-limiting orifice - requires the existence of a pressure switch to cut off the source of high pressure but does not eliminate the need for the primary protective device. The primary protective device should be located as close as possible to the high-pressure source. The primary relief device should be designed and sized to accommodate liquid flow if it is possible to vent LH₂ through it. Additionally, consideration should be given to protection from overpressure caused by abnormal conditions peculiar to LH₂ tankage and piping, such as insulation failures.
- (3) Each section of a vacuum jacket system should be protected with a relief device. This device, possibly a rupture disk, should limit the pressure in the annulus to not more than 10 percent above the lesser of the external design pressure of the inner line or the design pressure of the jacket. Capacity consideration for the jacket should be based on a catastrophic failure.

505 HYDROGEN VENT AND FLARE SYSTEMS

a. General.

Hydrogen shall be disposed of by venting unused-unburned hydrogen and/or by using suitable burning systems. Hydrogen systems and components must be equipped with venting systems satisfactory for normal operating requirements and for protection in the event of an emergency. All dewars, storage, and flow systems shall be equipped with unobstructed vent systems designed to safely dispose of hydrogen and prevent the entry and accumulation of atmospheric precipitation. The vent systems should be equipped for weather protection, and any lines leading to the vent stack should be long enough to warm the hydrogen to above liquid-air temperature. Over-the-road dewar vent systems should be connected to a building hydrogen vent system when the dewar is parked near a building. The vent systems should be designed to carry vented hydrogen to

safe-release locations above the roof. The vent systems should be designed to support the excess load caused by venting the liquid or gas. The vent stacks shall be placed to avoid possible contamination of air intakes leading into nearby buildings and designed to keep air out of the stack.

b. Venting.

The allowable quantities of hydrogen that may be vented are subject to conditions such as wind direction, wind velocity, proximity of inhabited buildings, vent stack height, local discharge limitations, or other environmental restrictions. Quantities of hydrogen of 0.113 to 0.226 kg/s (0.25 to 0.50 lb/s) have been successfully vented from a single vent 5 m (16 ft) high (NASA TMX-52454 1968). Multiple roof vents at least 5 m (16 ft) apart across the prevailing wind may be used. The use of multiple vents is preferred rather than using a collection header and a single vent stack for multiple sources requiring venting.

- (1) Interconnecting vent discharges to the same vent stack may overpressurize parts of the vent system. The vent system must be designed to handle the flows from all discharges, or the flow may back into parts of the system. Inadequate designs also may effectively change the release pressure on all relief valves and rupture disks connected to the vent system. Overpressure in the vent system, which may be very high (NFPA 68 1994), can cause overpressure and failure of connected apparatus.
- (2) High-pressure, high-capacity vent discharges and low-pressure vent discharges should not be connected to the same vent stack unless the vent capacity is sufficient to avoid overpressurizing the weakest part of the system.
- (3) The discharge from vacuum pumps should be ducted to suitable vents.
- (4) Small quantities of hydrogen may be disposed of outdoors through vent stacks of suitable heights. A molecular seal, flapper, check valve, or other suitable device should be provided in the flow and transfer systems near the atmospheric discharge to limit the backflow of air. The vent piping should be purged to ensure that a flammable mixture will not develop in the piping when hydrogen is introduced. Nitrogen gas may

be used as a purge and blanketing gas when process temperatures are above 77 K (-320 °F); for lower temperatures, helium gas must be used. Hydrogen gas may be ignited by static electrical charges as it leaves the vent piping. A helium or nitrogen gas purge, as appropriate, should be made available to extinguish any flame, and the vent stack must be located to prevent a fire hazard if adequate atmospheric dispersion is not available. Gas or liquid backed into vessels or transfer lines by emergency shutdown conditions must be released or vented in a safe manner.

c. Hydrogen Disposal by Burning.

- (1) Larger quantities of hydrogen that cannot be safely handled by roof vent systems are best disposed of in a burn-off system in which the liquid or the gas is piped to a remote area and burned with air in a multiple burner arrangement. Such systems shall have pilot ignition, warning systems in case of flameout, and means for purging the vent line. The design of a hydrogen disposal system also must provide sufficient assurances of the following:
 - (a) Hydrogen issuing from the flare stack will be disposed of safely.
 - (b) The flare stack system will prevent explosions within the stack.
 - (c) The radiation flux levels from burning hydrogen will not harm personnel or damage the facility.
- (2) Diffusion flames are most frequently used in flare stack operations. Combustion air comes from the open atmosphere around the downstream end of the stack and is not mixed with the hydrogen within the stack. Although disposing of hydrogen by flaring is essentially safe, hazards do exist. The hazards are flame stability, flame blowoff, and flame blowout.
- (3) Malfunctions in flare stacks generally have occurred at low flows with air forced downward from the atmosphere. Stack discharge velocities should be from 10 to 20 percent of the sonic velocity in hydrogen. When the flow is too low to support stable combustion, a continuous purge or a slight positive pressure shall be provided, or the stack shall be designed to limit back flow of air into the stack (Section 505b.(4)).

- (4) Negative pressures can be created and maintained in the vent system for flare stack systems in which high flow rates may occur. Extra care must be taken to ensure the vent systems is leak tight to avoid air intrusion and possible detonation.
- (5) Hydrogen flow through the flare stack must be within the operational velocity that provides for stable combustion. Stream velocities below the low limit may cause the flame to drop or flash back into the stack. Velocities above the high limit may cause the flame to blow off or to blow out. Operations outside the limits may introduce air into the stack or release unburned hydrogen into the atmosphere. Experiments performed with hydrogen and helium demonstrated that high concentrations of air (60 to 85 percent by volume) could occur at substantial distances within the flare stack during the upward flow of the gases. Figure A4.1 gives experimental data showing when the flame was observed to enter the flare stack as a function of stack diameter and hydrogen flow. Figure A4.2 shows a plot of the boundary velocity gradient versus the percentage of hydrogen defining the blowout and stable flame regions. Figure A4.3 shows predicted flame shapes in crosswinds for hydrogen, methane, and benzene. Appendix B, Example 8 analyzes a hydrogen vent-flare system.
- (6) The liquid or gas should be piped a safe distance from the work and storage areas with flared venting systems. Water pond burning may be used for rapid releases of large quantities as well as relatively long releases. The hydrogen is dispersed through a submerged pipe manifold to evolve into the atmosphere where it is ignited and burned. The water serves as a seal to prevent back mixing of air into the distribution manifold and pipeline and provides some protection for the manifold from thermal radiation damage.
- (7) Flare stack exits should provide good corona dissipation and be equipped for weather protection. The lines from LH₂ or SLH₂ systems should be long enough to warm the hydrogen to above liquid-air temperatures (about 81 K, -314 °F), preventing liquid-air from flowing back into or around the system and creating a highly oxidizing environment.

d. Hydrogen Disposal Into Exhaust Systems.

Disposal of hydrogen through an exhaust system requires approval of the AHJ at the controlling NASA center. Such approval shall require the hydrogen concentrations in air to be limited to less than 25 percent of the LFL unless the exhaust system has been designed to contain a hydrogen-air detonation.

e. Deflagration Venting.

- (1) Hydrogen-air deflagrations subject to potential confined spaces or closed vessels should be vented to prevent explosions. The maximum deflagration pressure for a given GH_2 -air mixture is calculated and an appropriate vent area is provided (NFPA 68 1994). Appendix B, Example 3 shows such a calculation.
- (2) Explosion vents should not be connected to hydrogen vent systems.

f. Explosion Prevention.

The design, construction, operation, maintenance, and testing of systems for the prevention of deflagration explosions is accomplished by means of one or more of the following methods (NFPA 69 1992):

- (1) Control of oxidant concentration
- (2) Control of combustible concentration
- (3) Explosion suppression
- (4) Deflagration pressure containment
- (5) Spark extinguishing systems

506 CONTAMINATION

a. General.

The storage and piping systems, including system components, should be designed and installed to allow cleaning of the hydrogen system and effective maintenance of a clean system. Contamination shall be minimized.

b. Filters.

Adequate filters should be used on hydrogen and associated systems. The filter should be placed to effectively collect the impurities in the system and should be accessible for cleaning. Filter elements made of noncalendered woven wire mesh are recommended. Sintered metal elements are not suitable because metal tends to spall and get into the system. As a general rule, the filter element should retain 100 percent of the particles greater than 150 μm (0.0059 in.) diameter. Some systems may have more stringent requirements. Provisions for filter isolation and removal of any trapped oxygen or other solid contaminants should be provided.

c. Interconnected Systems.

- (1) The arrangement of systems shall be designed so that cleaning or draining practices can be adjusted to ensure dead-end volumes and possible traps are adequately cleaned.
- (2) Adequate means should be provided to prevent damage to the lower-pressure system and its components for interconnected systems operating at different pressure levels.
- (3) Protection.
 - (a) Pressure-regulating valves, shutoff valves, and check valves do not adequately protect low-pressure systems connected to high-pressure systems. Pressure relief should be in the low-pressure system. The hydrogen supply should be disconnected and capped when the pressure differences in the systems cannot be used in conjunction with relief valves for preventing leakage. Relief valves and burst disks also are required for the protection of third piping systems supplied through valves from the high- or low-pressure system.
 - (b) Check valves should not be used when bubble-free tightness is required. Bottled gases have been contaminated when check valves leaked in interconnected systems. Two check valves in series have been found to be unreliable. Check valves may be used when system contamination is not important and bottle pressures are not permitted to fall within 276 kPa gage (40 psig) of the contaminating pressure. Two shutoff valves with a bleed valve between them should be used if the contaminating pressure should be higher than the supply pressure.

- (4) Explosion Hazards. Explosion hazards in interconnected systems, caused by hydrogen leakage from one system into another, should be prevented by considering the following principles:
- (a) Leakage through valves should always be considered a possibility.
 - (b) Overpressurization safety systems should be used for protection.
 - (c) The hydrogen supply should be disconnected and capped when the system is not in active use and system pressure differences cannot be used in conjunction with relief valves to prevent unwanted leakage.
- (5) Contamination with Oxygen, Air, or Nitrogen.
- (a) Contamination may occur from interconnected systems. Check valves should not be relied on to prevent contamination.
 - (b) Localized concentrations of solid oxygen particles can approach and reach flammable range. Impurities from the pressurization gas can accumulate in the LH₂ during pressurization for transfer operations. Accumulation is less likely when liquid is frequently withdrawn from vessels. Therefore, higher boiling point impurities (everything but helium) will accumulate when liquid is stored and not used and tanks are occasionally topped to make up evaporation losses.
 - (c) The following precautions should be observed:
 - 1 Hydrogen liquid should be stored under positive pressure to aid in preventing external contaminants from entering the system.
 - 2 The pressurizing gas should be as free as practical of impurities. The levels of impurities, especially oxygen, shall be known to ensure the pressurant gas is satisfactory.
 - 3 All transfer and handling equipment for GH₂ and LH₂ shall be clean, dry, and purged.

4 Hydrogen should not be recirculated if contamination cannot be prevented.

- (6) Permanent liquid storage facilities should be periodically monitored or sampled for build up of condensable impurities.
- (7) Hydrogen systems should be maintained under a positive pressure to prevent air, moisture, and particulate contamination when they are not in use.

507 VACUUM SYSTEM

a. General.

A vacuum system is an important tool in maintaining insulating vacuum and purging (removing unwanted hydrogen or other gases from a hydrogen system). The vacuum system includes such components as a vacuum pump (or pumps), valves, instrumentation (vacuum gages), protection from over pressure, and a cold trap.

- (1) Important considerations for a vacuum system include: flow regimes (laminar or viscous flow, transition or mixed flow, and turbulent or free molecular flow), degree of vacuum (such as rough, high, and ultrahigh), conductance of the vacuum system, pump-down time, materials of fabrication, fabrication techniques to eliminate virtual leaks, seals and gaskets, emissivity of inner surfaces of the vacuum system, and out-gassing of components in the vacuum system.
- (2) GH_2 properties involved in a vacuum system that services GH_2 include (some of these may be related to instrumentation and measurements) the following: GH_2 thermal conductivity, hydrogen ionization efficiency, the gas molecule average velocity, molecular diameter, hydrogen permeation, hydrogen absorption, and hydrogen viscosity.
- (3) Vacuum systems should be designed with sufficient volume and necessary system pressure for all required uses throughout the system. Vacuum pumps shall be selected for the highest required degree of vacuum in the system. Pump capacity shall be based on the total calculated peak demand of the system and the pump should meet this peak demand when continuously operating. Multiple pumps shall be installed

507a

with the calculated peak demand divided equally among the units when pumps larger than 3.7 kW (5 hp) are required or continuity of service is necessary. Standby pumps should not be installed unless justified by mission criticality. Vacuum vessels should be provided for reserve storage, momentary peak demands, pump pulsation absorption, and entrapment of liquids and other foreign materials that may be introduced into the system. The vacuum vessels should be sized to prevent the pump from cycling too frequently (NHB 7320.1 1982).

b. Hydrogen Vacuum Pumps.

GH_2 is a difficult gas to pump for a variety of reasons. Vacuum pump considerations include the following:

- (1) The compression ratio of light gases, such as GH_2 and He, is lower than that of the heavy gases for a diffusion pump because of their high thermal velocity and small collision cross section. The compression ratio of a diffusion pump for heavy gases will be of an order of 10^8 to 10^{10} , whereas, it can be on the order of 10^3 to 10^6 for light gases.
- (2) Modern turbo-molecular pumps have high pumping speeds, large hydrogen compression ratios, and low ultimate pressures. The compression ratio is exponentially dependent on rotor speed and the square root of the molecular weight of the gas. The light gases, such as helium and hydrogen, will have compression ratios much smaller than the heavy gases. The speed ratio for argon is about unity for a blade tip velocity of 400 m/s (1312 ft/s); it is about 3.0 for GH_2 . Compression ratios of 1.6 for GH_2 and 4 for argon are obtained for a blade angle of 30° and velocity of 400 m/s (1312 ft/s). The net compression ratios are calculated to be approximately 100 for GH_2 and 10^6 for argon if 10 disks (5 rotors and 5 stators) are cascaded. A special blade design for pumping hydrogen is used for optimizing performance. No conventional LN_2 trap is required on a turbo-molecular pump to stop bearing or mechanical pump fluid backstreaming. The compression ratios for all but GH_2 , the lightest gas, are high enough that none will backstream from the foreline side to the high vacuum side, provided the pump is rotating at rated angular velocity. An LN_2 -cooled surface will not trap the small amount of GH_2 that does backstream into the work chamber because of its low compression ratio (O'Hanlon 1980).

- (3) Cryogenic pumps do not handle all gases equally well. The capacity for pumping He and GH_2 is much less than for other gases. Because cryo-surfaces condense vapors, they can accumulate significant deposits able to react with one another or with the atmosphere when warmed. Cryogenic pumps easily pump large amounts of GH_2 , have no high voltages, and generate no hydrocarbon, metal film flakes, or other contaminants of their own (O'Hanlon 1980).
- c. GH_2 will diffuse rapidly in an evacuated space because of average velocity of the gas molecule (average velocity is related to the absolute temperature and the molecular weight). The average velocity for GH_2 is 1750 m/s (5741 ft/s), compared to 464 m/s (1522 ft/s) for air.
 - d. A leak in a system being evacuated could result in air being pulled into the system, or gas being pulled in from another part of the system. Consequently, a hydrogen-air mixture could be formed.
 - e. Virtual leaks can be reduced by techniques such as using continuous welds inside and intermittent welds outside avoiding screw threads and internal blind holes.
 - f. Elastomeric materials used in hoses (such as, rubber and Tygon) will absorb and permeate hydrogen readily. Thus, the length of such hoses should be minimized.
 - g. The exhaust of rotary mechanical pumps should be vented outside of a building because of oil vapors in the exhaust (an oil mist separator may be used to reduce the oil vapor in the exhaust, but it does not adequately remove all the oil vapors). The vent line should not run vertically from the exhaust connection because water or other vapors that have condensed on the cooler walls of the vent line will drain into the pump and contaminate the fluid. This problem may also be addressed by the addition of a sump at the exhaust connection to collect the vapors before they can flow into the pump.
 - h. Condensation on the interior walls of the vacuum pump can occur when large quantities of water or other condensable vapors are being pumped. Gas (usually room air) is admitted through a ballast valve to avoid condensation and its resulting problems. The ballast valve is positioned to allow the ballast gas (which can be as much as 10 percent of the pump displacement) to enter the chamber during the compression stage. This could result in the creation of a combustible mixture within the pump when a system containing hydrogen is evacuated.

CHAPTER 6: HYDROGEN AND HYDROGEN FIRE DETECTION

Note: The system design should ensure that detection occurs immediately and operating personnel are notified as appropriate if hydrogen leaks into the atmosphere or a hydrogen fire occurs.

600 HYDROGEN DETECTION

a. General.

GH₂ is colorless and odorless and normally not detectable by human senses. Means shall be provided to detect the presence of hydrogen in all areas where leaks, spills, or hazardous accumulations may occur.

- (1) The hydrogen detection system must be compatible with other systems such as those for fire detection and fire suppression. The detection units should not be ignition sources. Total times for detection, data summary, transmission, and display should be as short as possible. A portable hydrogen detector should be available.
- (2) Well-placed, reliable hydrogen detectors are imperative for safe installation. Continuous automatic sampling equipment with sample points strategically located should be provided as needed. The sampling equipment shall be calibrated to provide for short response times and detection of at least 25 percent of the LFL. Detection of LH₂ or SLH₂ leaks by observation alone is not adequate. Although a cloud of frozen air and moisture may be visible, such a cloud is not a reliable sign of a hydrogen leak because clouds of water vapor also rise from cold, exposed surfaces when no hydrogen leak is present.
- (3) The number and distribution of detection points and time required to shut off the hydrogen source should be based on factors such as possible leak rates, ventilation rates, and the volume of space for an interior location. The detection signal also should actuate warning alarms and automatically effect shutoff whenever practicable.

600a

600a

- (4) The design of a reliable hydrogen detection and monitoring system follows:
 - (a) Evaluate and list all possible sources to be monitored (valves, flanges, connections, bellows, etc.) and provide valid justification for sources not monitored.
 - (b) Evaluate the expected response time of the leak detection system to ensure compatibility with the responding safety system.
 - (c) Provide visual and audible alarms as necessary when the worst allowable condition (red line) is exceeded. The allowable condition must still be in the safe range, but a warning indicates a problem.
 - (d) Provide portable detectors for field operations or isolated areas and permanently installed detectors for remote-automated operations.
 - (e) Utilize a program to maintain and periodically recalibrate detectors to ensure acceptable performance.
 - (f) Determine the number and distribution of sampling points in the hydrogen detection system based on the possible leak rate, ventilation amount, and area size. Consideration should be given to methods of routing hydrogen to the detector.
- (5) The appropriate hydrogen detection system should be used when explosion suppression techniques using inert gas purges are installed (NFPA 69 1992). The possibility of oxygen deficiency must be considered when purge gases are used.
- (6) Tables A6.1, A6.2, and A6.3 give information on hydrogen gas detectors. Table A6.1 shows a list of typical GH₂ detectors. Table A6.2 shows a survey and analysis of commercially available hydrogen sensors. Table A6.3 shows sensitivity limits of hydrogen detectors.

b. GH₂ Detection Specifications

- (1) Detection and alarm at 1 percent by volume hydrogen concentrations in air, equivalent to 25 percent of the LFL, is required for enclosed areas in which GH₂ buildup is

possible (29 CFR 1910.106 1996). Detection and alarm at 0.4 percent by volume hydrogen concentrations in air (equivalent to 10 percent of the LFL) is required for permit-required confined spaces (29 CFR 1910.146 1996).

- (2) It may be necessary to conduct a gas sample through a sensing line to the sensor under conditions in which the sensor cannot be located at a leak source. The response time under such conditions depends on the length of the sensing line. Response times should be 1 s or less if possible.
- (3) A 1 percent by volume hydrogen concentration in an exhaust purge should generate an alarm. A higher hydrogen concentration at a purge exhaust indicates a major leak or a fire hazard after the purge is exhausted in air.
- (4) A 1 percent by volume hydrogen concentration should generate an alarm in a vacuum chamber when it is not evacuated and at anytime in the evacuation duct.
- (5) A 1 percent by volume hydrogen concentration at any point 1 m (3.28 ft) from the hydrogen equipment should generate an alarm in areas around hydrogen facilities. The performance of the detectors depends on the location of sensors and the leak and wind directions, and they may fail to indicate a leak. A larger number of sensors may be necessary to survey the area of concern.
- (6) Specifications for hydrogen sensors should include requirements for the following:
 - (a) Minimum gas concentration detection requirements
 - (b) Full scale range of the detector system
 - (c) Level of concentration for which alarm detection is required
 - (d) Response time of the detector system
 - (e) Accuracy of sensors
 - (f) Reliability and recalibration frequency
 - (g) Interface to facility safety and shutdown systems

c. Detection Technologies.

- (1) Bubble testing is one of the simplest methods of leak detection; however, it is not a continuous monitoring system, needs to be applied directly on the source of the leak, can only be used with inert gases at low pressure, and is limited to temperatures above freezing. Bubble solutions can detect very small leaks but do not measure concentrations.
- (2) Catalytic combustion sensors detect hydrogen gas by sensing the heat generated by the combustion of hydrogen and oxygen on the surface of a catalytic metal such as palladium or platinum. The sensors work well for detection of hydrogen in the 0 to 4 percent by volume (0 to 100 percent LFL) in air but do not operate in inert environments or 100 percent by volume hydrogen. Sampling systems can be designed to mix air in with the sample before exposure to the catalytic sensor for operation in inert environments; however, this results in a longer response time. Catalytic sensors such as sintered bronze utilize a heated filament and need to be enclosed in flame arrestors to prevent the sensors from becoming ignition sources. Also, catalytic sensors are not hydrogen specific and will respond to other combustible gases such as methane.
- (3) Thermal conductivity sensors work well in stable environments with minimal temperature variations and a constant background gas. Thermal conductivity sensors work well in background gases that have a thermal conductivity that varies significantly from hydrogen, such as air or nitrogen. However, they do not work in helium backgrounds; a significant drawback for LH₂ systems because helium purges are often required because helium does not solidify at LH₂ temperatures. Thermal conductivity sensors can go from 0.02 to 100 percent by volume hydrogen detection.
- (4) Electrochemical sensors typically utilize a liquid electrolyte and require a gas permeable membrane for the hydrogen to reach the electrolyte. The sensors are low power and can operate from 0.02 to 100 percent by volume hydrogen. Exposure of the membrane to cryogenic or time-varying temperatures greatly affects the gas diffusion and can make the sensor unreliable.
- (5) Semiconducting oxide sensors rely on surface effects with a minimum oxygen concentration present and do not work in inert environments. Semiconducting oxide sensor can operate

at lower powers than catalytic sensors, but performance at lower temperatures is degraded. Semiconducting oxide sensors are relatively new and not as common as the older catalytic based systems.

- (6) Mass spectrometers are extremely sensitive (1 ppm), very specific to the gas being detected, linear over a wide dynamic range, and provide continuous monitoring. The complexity and high cost of mass spectrometers requires skilled operators and the use of sampling systems to monitor multiple locations with one instrument. The use of long sample lines can significantly reduce the response time.
- (7) Gas chromatographs are similar to mass spectrometers in their sensitivity and accuracy; however, measurement times are extremely slow. Gas chromatographs typically are used in a laboratory to analyze the gas collected in the field with sample bottles.
- (8) Ultrasonic leak detection can be used when hydrogen specificity is not required and there is minimal background interference noise. Ultrasonic systems typically are used to pinpoint the source of a leak, and cannot measure whether a combustible mixture is present.
- (9) LH₂ leaks can be detected through loss of vacuum and by observing the formation of frost, the formation of solid air, or a decrease in outer wall temperature on vacuum-jacketed equipment.
- (10) Glow plugs and heat sensors are a less common technique used for rapid leak detection. The glow plugs ignite any combustible mixture present and, a heat sensor detects the fire and provides rapid shutdown of the process. The theory is it is better to burn the hydrogen gas rather than letting a combustible mixture accumulate, and the facility can shut down before the fire can do significant damage if a fire is started.

d. Hydrogen Detector Installations at NASA.

- (1) Launch and Ground Test Facilities.
 - (a) Catalytic sensors detecting over a 0 to 4 percent (0 to 100 percent of LFL) range are used for sampling in cryogenic and gas transfer systems.

- (b) Mass spectrometers detecting 0.01 to 10 percent of the LFL are used for sampling purged enclosures.
 - (c) Catalytic or semiconductor oxide sensors with air mixing detecting over a 0 to 4 percent (0 to 100 percent of LFL) range are used as portable sniffers.
 - (d) Gas chromatography, which has parts-per-billion-by-volume capability, is used for the detection of hydrogen in purged lines and vessels through the use of samples collected in sample bottles.
- (2) Samples are taken in sample bottles at various times during ascent of flight systems. The samples are analyzed after flight by a gas chromatograph.
 - (3) The atmosphere of indoor laboratories is analyzed using catalytic sensors detecting over a 0 to 4 percent (0 to 100 percent LFL) range. Various chemicals (such as room temperature vulcanizing adhesives) in an indoor environment can poison the catalytic sensors.

601 HYDROGEN FIRE DETECTION SYSTEMS

a. Hydrogen Fire Detection.

- (1) A fire detection system should be capable of detecting, at a minimum distance of 4.6 m (15 ft), the flame from the combustion of 5.0 L/min (0.18 ft³/min) of GH₂ at NTP flowing through a 1.6 mm (0.0625 in.) orifice to produce a 20 cm (8 in.) high flame. Other sensors are available to detect flames at distances greater than 4.6 m (15 ft).
- (2) The fire detection should not be susceptible to false alarms from the sun, lightning, welding, lighting sources, and background flare stacks.
- (3) The fire detection system response time should meet the requirements for the specific application for prevention of loss of facility, equipment, and personnel protection.
- (4) Fixed systems are required for continuous monitoring of remote operations, and portable systems are required for field operations.

- (5) Special imaging systems are required for determining the size and location of a flame for assessment of the hazard because hydrogen flames are not visible during daylight conditions.
- (6) Table A6.4 gives information on hydrogen fire detection. Figures A6.1 through A6.4 provide additional information on optical detection and flame emission properties. Figure A6.1 gives irradiance of common IR sources. Figure A6.2 gives atmospheric IR transmission and GH₂-air flame emission. Figure A6.3 gives UV/VIS/near-IR emissions. Figure A6.4 gives GH₂-air flame components.
- (7) The solar-transmission-emission-detector sensitivity trade off follows:
 - (a) Solar. The radiation from the sun can overpower the hydrogen flame emission, resulting in an invisible flame during the day, in the visible spectrum.
 - (b) Transmission. A large percentage of the radiation emitted from a hydrogen fire originates from the hot water molecule. Emission peaks occur at the same location water (humidity) in the atmosphere absorbs radiation.
 - (c) Emission. Hydrogen fires tend to emit over a broad range and are not characterized by extreme peaks such as the 4.3×10^{-6} -m (1.4×10^{-5} -ft) peak for hydrocarbon fires.
 - (d) Detector Sensitivity. Different types of detectors are sensitive to different parts of the spectrum. A higher sensitivity detector at a smaller emission peak may outperform a less sensitive detector at a larger emission peak.

b. Detection Technologies.

- (1) Thermal fire detectors classified as rate-of-temperature-rise detectors and overheat detectors have been manufactured for many years and are reliable. Thermal detectors need to be located at or very near the site of a fire.

- (2) Optical sensors for detecting hydrogen fires fall into two spectral regions: ultraviolet (UV) and infrared (IR). UV systems are extremely sensitive; however, they are susceptible to false alarms and can be blinded in foggy conditions. Infrared systems typically are designed for hydrocarbon fires and are not very sensitive to hydrogen fires.
- (3) Imaging systems mainly are available in the thermal IR region and do not provide continuous monitoring with alarm capability. The user is required to determine if the image being viewed is a flame. UV imaging systems require special optics and are very expensive. Low-cost systems, using low-light silicon charge coupled device (CCD) video technology with filters centered on the 940- and 1100-nm emission peaks, have been used at some facilities.
- (4) A broom has been used for locating small hydrogen fires. The intent is a dry corn straw or sage grass broom easily ignites as it passes through a flame. A dry fire extinguisher or throwing dust into the air also causes the flame to emit visible radiation. This technique should be used with care in windy, outdoor environments in which the light hydrogen flame can easily be blown around.

c. Hydrogen Fire Detector Installations at NASA.

- (1) Launch and Ground Test Facilities.
 - (a) Transfer systems use thermal protect-o-wire, temperature sensors, and UV-only optical fire detectors.
 - (b) Launch operations, and rocket engine testing use thermal (8 to 12 μm), Mid-IR (2.7 μm), and near-IR (940 nm and 1100 nm) imaging; UV imaging systems (280 nm); and heat sensing devices.
- (2) Flight Systems. Flight systems use fire detection equipment as determined appropriate by the AHJ at the controlling NASA center.
- (3) Indoor Laboratories. Indoor laboratories use appropriate, commercially available equipment.

CHAPTER 7: OPERATING PROCEDURES

Note: The best single investment in safety is trained personnel following approved operating procedures, standards, and guidelines.

700 GENERAL POLICY

a. Personnel.

Full consideration for the safety of personnel at and near hydrogen facilities should start in the earliest planning and design stages. Safety documentation made available to personnel should describe the safety organization and comment specifically on inspections, training, safety communications and meetings, operations safety and instruction manuals, accident investigations, and safety instruction records. Training should familiarize personnel with the physical, chemical, and hazardous properties of the cryogenics and the nature of the major process systems of the facility, in accordance with 29 CFR 1910.120 (1996). The buddy system (two qualified personnel shall be present) must be followed when required. No more than the minimum personnel necessary should be present in a hazard area.

b. Standard Operating Procedures.

Standard operating procedures, with checklists as required, shall be developed for hydrogen operations (29 CFR 1910.103 1996, NFPA 50A 1994, and NFPA 50B 1994). All hydrogen standard operating procedures shall be reviewed and approved by the AHJ at the controlling NASA center. Procedures shall be periodically reviewed for observance and improvement (NMI 1710.3 1994). Safety is achieved while working with hydrogen, by adhering to the following principles:

- (1) Prevent hydrogen leaks.
- (2) Keep constant watch to immediately detect accidental leaks, and take proper action.
- (3) Prevent accumulations of leaked hydrogen using plentiful ventilation.
- (4) Eliminate likely ignition sources, and suspect unknown ignition sources.

- (5) Ensure safe operation of cryogenic systems through periodic leak and flange joint torque checks.
- (6) Always assume hydrogen is present, and verify the system has been purged to less than 1 percent when performing system maintenance on a hydrogen system. Always assume oxygen is present, and verify the system has been purged to the appropriate level when reintroducing hydrogen into a system.

c. Special Operating Procedures.

Special operating procedures should be developed to counter hazardous conditions when the design and use of safety equipment do not reduce the magnitude of an existing or potential hazard. The procedures should be verified by demonstration tests.

d. Repairs, Alterations, and Cleaning.

Repairs, alterations, cleaning, or other operations performed, in confined spaces in which hydrogen vapors or gases are likely to exist, should have an approved safety procedure. As a minimum, the safety procedure shall include the evacuation or purging requirements necessary to ensure safe entry as well as the maximum flammable limits allowed of 25 percent of the LFL in the confined space. The limit is 10 percent of the LFL in permit-required confined space. Personnel engaged in the operations shall be advised of the hazards that may be encountered, and at least one person shall be immediately available while the work is being performed to administer emergency rescue, should it be necessary (NHS/IH 1845.2 1983). An attendant shall be available for work in permit-required confined spaces (29 CFR 1910.146 1996).

e. Modifications, Repairs, or Decommissioning.

- (1) Before modifications, repairs, or decommissioning, cryogenic vessels should be drained, warmed to ambient temperature, purged and sampled, and all pipelines disconnected or flanged and tagged. Disconnected lines should have blank flanges with gaskets to prevent the leak or spill of hazardous materials near the vessel. Any electric power supply to equipment within the vessel should be deenergized. Vessels placed in standby condition should be maintained under a positive pressure of dry GN₂.
- (2) The vacuum annulus should be warmed and purged with dry GN₂, and the purge supply should be sufficient for warming

the insulation to remove absorbed moisture or other gases for major repairs or modifications. Warm-nitrogen purge rates of 4 to 7 CM/min·m³ (4 to 7 CF/min·ft³) of insulation should be sufficient. Approved procedures shall ensure that inert gas purging does not result in a potential asphyxiation hazard to personnel. Purging is more effective when a sparger arrangement of small breathers is located at the bottom of the casing.

f. Contamination Control.

(1) General.

- (a) Cleaning procedures should be established and a method of effective contamination controls developed to maintain the hydrogen systems to the cleanliness levels required. The procedures shall protect personnel from exposure to toxic chemicals or environments in which asphyxiation could occur. Effective cleaning removes greases, oils, and other organic materials as well as particles of scale, rust, dirt, weld spatter, and weld flux.
- (b) LH₂ or SLH₂ exposed to air can form a slurry of solid oxygen and nitrogen which tends to be richer in oxygen than air. Solid contaminants can contribute to the generation of static electricity in flowing systems and should be held to a minimum. Filter elements in LH₂ servicing systems should be regenerated well before their capacity is reached. Explosions have occurred in filters contaminated with solid air. The warm-up and purge of LH₂ transfer systems usually accomplishes the regeneration of filters. SLH₂ systems require special considerations because of the presence of solid hydrogen particles.
- (c) Complete systems may require disassembly for suitable cleaning. Components that could be damaged during cleaning shall be removed and cleaned separately. The cleaning of multiple-branch piping systems should be integrated into the sequence of construction operations.
- (d) It is necessary to determine or estimate the nature, possible locations, and quantities of contaminants present to choose the most practical method of

cleaning, the level of cleanliness, the inspection procedures, and the testing for each group of cryogenic fluids. The fluid operating levels including temperature and pressure may also affect the cleanliness level desired. Passage arrangement also should be studied so cleaning, washing, or draining practices can be adjusted to be sure dead-end passages and possible traps are adequately cleaned.

- (e) The compatibility of cleaning agents with all construction materials definitely must be established before use. The cleaning methods include steam or hot-water cleaning, mechanical descaling, vapor degreasing, solvent degreasing (washing), detergent degreasing (alkaline washing), acid cleaning (pickling), and purging.

Note: The choice of organic cleaning solvents and associated procedures currently is being reviewed and modified. The organic solvent of choice has been chlorofluorocarbon 113 (trichlorotrifluoroethane, MIL-C-81302B (1991), Amendment 1, type II), because it is an ideal solvent for performing particle count and nonvolatile residue analysis. It is also nonflammable and relatively nontoxic. Production of chlorofluorocarbons currently is restricted and is being phased out because the release of the compounds into the atmosphere damages the environment. Alternative cleaning solvents are being developed and investigated and probably will come into use in the near future. Alternative cleaning solvents include the new hydrochlorofluorocarbons (HCFC), deionized (DI) water, and isopropyl alcohol (IPA). The effects of these changes on the cleaning of hydrogen systems have not yet been assessed.

- (f) A recommended cleaning procedure for hydrogen systems follows:
 - 1 All loose particles such as sand, grit, rust, and weld splatter should be removed from a warm system, by flushing the system or component with an approved solvent to degrease and dry,

and flushed a second time with demineralized water.

- 2 The system should be dried by evacuation or by flowing dry nitrogen gas through it. See 4 if the system cannot withstand a vacuum. The system should be cold-shocked with LN₂ to break loose attached particles. The quantity of LN₂ used should not exceed the weight limit of the vessel if LN₂ cold-shock is used to break loose attached particles. The particles can be flushed out with LN₂ flowing through filters. The filters should be cleaned separately.
 - 3 Systems should be dried by three cycles of evacuation and purging through a cold trap before filling with hydrogen gas. Three cycles usually will dry a system so the cold trap shows no further collection.
 - 4 The system may be dried by flowing hot nitrogen gas through it if the system cannot withstand a vacuum. The nitrogen gas temperature should be sufficient to remove water, but should not be too hot for the insulation material.
 - 5 Cleaning fluids shall be disposed of according to appropriate procedures.
- (g) Flexible hoses used should be sealed and assurance indicated that certified cleanliness has been maintained. The ends of the hoses should be closed with metal caps, covered with a clean plastic bag or sheet, and sealed with a tamperproof seal tape as required.
- (h) The frequency at which filters should be cleaned depends on the amount of use and impurities in the fluid. Operators watch increases in pressure drops and clean filters as needed. Filters are cleaned by disconnecting, warming, draining, flushing with an approved solvent or ultrasonic cleaning, and thoroughly drying. Filters must not be cleaned by back-flushing through the system.

700f

(2) Decontamination.

- (a) Vessels should periodically be decontaminated by draining the contents and letting the product container warm to permit removal of all contaminants. The warm-up period is determined from the service history. Experience shows that contamination occurs in frequently filled and emptied roadable dewars. Large fixed dewars that are not often filled and emptied do not require frequent decontamination unless they have been subjected to a contaminating condition. The interval depends on the degree of contamination and shall be determined by the AHJ at the controlling NASA center.
- (b) The container should be vacuum purged, if strong enough to withstand a vacuum of 1.33 kPa (10 torr), to ensure decontamination. A warming or pressure purge is necessary if the dewar is not strong enough.

g. Hazards of Substituting Dewars.

- (1) Structural weakness of the vessel. LH₂ and liquid He dewars, as ordinarily constructed, may not be strong enough to hold LOX, liquid air, or LN₂.
- (2) Hydrogen and helium equipment can be used interchangeably although it is not recommended. No other substitutions are permitted without approval by the AHJ at the controlling NASA center. The contents must be accurately marked on the vessel and its contents sampled for contamination in all cases.

h. Protective Clothing.

- (1) All personnel working with LH₂ or SLH₂ who may be exposed to cryogenic vapors shall have eye and hand protection. Face shields are required when operating any hydrogen system under pressure and connecting or disconnecting lines or components. Systems should be designed and operated to reduce potential for unprotected personnel coming in contact with uninsulated piping or vessels containing cryogenic hydrogen.

- (2) Properly insulated gloves should be worn when handling anything that comes in contact with cryogenic liquids or vapors. Gloves should fit loosely and remove easily. Adequate foot protection should be provided, and the trousers should be worn outside boots or work shoes. Open or porous shoes are not permitted.
- (3) Any clothing splashed or soaked with fuel vapors or oxidizers shall be removed until completely free of the gases.
- (4) Personnel should avoid wearing clothing made of nylon or other synthetics, silk, and wool because these materials produce charges of static electricity that can ignite flammable gas mixtures. Ordinary cotton, flame-retardant cotton, or Nomex[®] clothing is preferred. Gauntlet gloves, tight clothing, or clothing that holds or traps liquid against the body must be avoided.
- (5) Hearing protection shall be utilized as appropriate.
- (6) Personnel shall be provided appropriate protective clothing during cleaning or decontamination operations.

701 STORAGE AND TRANSFER PROCEDURES

a. LH₂ Off-Loading.

- (1) The procedures for LH₂ off-loading at NASA facilities shall include notification of the safety department or safety representative of the location, the time, and the amount of LH₂ to be off-loaded (NHB 1700.1 1993). The safety representative shall verify that a preoperation briefing has been conducted and approved procedures are used, emergency escape routes are clear, and the operational area is clean and free of combustible materials and ignition sources.
- (2) Contractor unloading procedures, vehicle schematics, and descriptions of the piping systems that interact with the NASA facility should be provided by the contractor to better determine the facility design and necessary precautions and procedures during and after unloading operations.

- (3) A checklist should be made of the operations to be performed by the supplier and user of the LH₂. No LH₂ transfer should begin unless there is a positive remote shutoff capability in the trailer or other supply vehicle system. This is necessary to protect the unloading area if a leak or spill occurs.

b. Purging.

The major step to be taken before loading an LH₂ vessel is to ensure the removal of any condensable gas. Condensable gas trapped in the vessel or transfer line solidifies and introduces a potential fire and explosion hazard. Appendix B, Example 10 analyzes the purging of a vessel. Three purge techniques are flowing gas, pressurizing-venting cycle, and vacuum purge.

- (1) A flowing gas purge is least likely to ensure a positively purged system. It requires the use of an inert gas flowing into one part of the system and flowing out another part of the system. Considerations include the volume to be purged, gas flow rate, dead ends, and purge duration. Turbulent flow should be achieved, or the flow rate should be sufficiently high that all parts of the system are thoroughly purged.
- (2) A pressurizing-venting cycle purge requires alternate pressurizing and venting of the system to progressively dilute air until a safe atmosphere is obtained. Air in the system is diluted with an inert gas (helium) to a positive pressure within the working pressure range of the vessel. The mixture is displaced by venting to the atmosphere. The system is repressurized with helium to the positive pressure, and the mixture is again vented to the atmosphere. A positive pressure must be maintained in the receiver during these procedures to prevent the backflow of air. An analysis for residual air in the system is a desirable means of verifying the completeness of the purge. LH₂ is now slowly introduced into the container. It is important that all voids or dead legs be adequately purged.
- (3) Vacuum purging requires fewer operations and produces a uniform concentration throughout the system. It is done by venting the system to atmosphere, evacuating to a relatively low pressure (1.33 kPa; 10 torr), repressurizing the system with an inert gas to a positive pressure, and again venting to atmospheric pressure. The operator must be sure the

container or system will not collapse when a vacuum is applied and air does not leak into the system when it is under a vacuum during vacuum purging.

(a) The use of inert gas before hydrogen.

1 The system is initially evacuated, to 1.33 kPa (10 torr) for example. The system is tested under static conditions to ensure it is tight, by observing the rate of pressure rise within the system.

2 Nitrogen, or helium if necessary, is introduced to atmospheric pressure. The system is re-evacuated to 1.33 kPa (10 torr). The system is ready for hydrogen gas.

(b) The use of hydrogen gas. The use of hydrogen gas is similar to the use of inert gas before hydrogen, except the inert gas step is omitted. The system is purged with hydrogen gas and evacuated for three complete cycles, after initial evacuation, to 1.33 kPa (10 torr).

(c) The use of inert gas before air. The use of inert gas before air is for purging GH_2 from a system.

1 The system initially is evacuated, to 1.33 kPa (10 torr) for example.

2 Nitrogen, or helium if necessary, is introduced to atmospheric pressure. The system is re-evacuated to 1.33 kPa (10 torr). The system is ready for air.

(4) New vessels containing air usually are purged with nitrogen or helium gas until the oxygen concentration, as measured from the vent system, is below 1 percent by volume (CGA G-5.4 1992). Hydrogen gas at ambient temperature is used for purging the nitrogen from the system.

(5) Any liquid remaining in vessels containing LH_2 or cold hydrogen vapor is removed through the liquid transfer hose to a liquid disposal system or allowed to boil off through the hydrogen pressure buildup coil.

701b

c. Loading Operations.

(1) Storage and transport vessels must be purged with an inert gas before the vessels are loaded. Over-the-road trailers can be pressurized to about 241 kPa gage (35 psig) and allowed to stand for 30 min before they are checked for leaks. The inert gas should be released through the vent system, maintaining about 3.4 kPa gage (0.5 psig) in the trailer. The oxygen content in the vented purge gas should be less than 1 percent by volume before the GH_2 is introduced (CGA G-5.4 1992).

(2) Liquid Level and Sampling.

(a) The procedures for filling LH_2 trailers and storage vessels must be controlled to prevent overloading. Overloading the vessels reduces the ullage space and may not only result in LH_2 leakage during transportation (for trailers), but could also cause unwarranted thermal cycling and result in the relief valves becoming inoperable.

(b) Composition acceptance tests should be performed on LH_2 in accordance with specification MIL-P-27201B (1971) and ASTM F310-70 (1980) before it leaves the filling site. The contents of storage and transport vessels engaged in continuous service also shall be sampled as required by the AHJ at the controlling NASA center. The residual products in trailers, rail-road cars, or barges irregularly used should be sampled and analyzed before loading and at arrival at the filling site (MIL-P-27201B 1971).

(3) LH_2 Transfers.

(a) Dewars shall be connected to an appropriate, periodically verified electrical ground. The dewars generally shall be inspected for leaks or mechanical defects and checked for pressure and vacuum. The connections should be cleaned and purged. Contamination should be avoided.

(b) Surfaces should be watched for condensed water because it indicates leaks or a deficiency in insulation. A leak check with a portable detector should be made after each assembly or alteration. An approved lubricant for O-rings should be used.

- (c) All transfers should be made in tightly closed systems. LH₂ should not be transferred into an open-mouthed dewar or allowed to come into contact with air, because it can become contaminated with solid air. Ground wires should be securely clamped across each coupling before transfer. The ground wires should be connected when the coupling is separated. All fuel transfers should be made against enough backpressure to prevent air migration. GH₂ and LH₂ shall not be transferred in electrical storms or if there is a fire near the facility. If begun, the transfer shall be terminated as directed by the AHJ at the controlling NASA center.
 - (d) Dewars and gas trailers should be disconnected from the test equipment after the transfer operation and moved away from the test facility as soon as practical. Dewars may remain connected between research operations at the discretion of the test conductor in controlled areas where large dewars are used and disconnection may constitute a hazard. Movements of dewars and tube trailers should be avoided during peak traffic hours.
- (4) Checklists are substantial aids to safe operations and are required for all except the most simple installations. There should be checklists of items concerned with safety of the test room and test area in addition to checklists of items pertaining to specific equipment. The checklists shall contain such items as combustible gas detection, ventilation, de-energizing of electrical ignition sources, posting of warning signs, and notification to plant protection and central control and other organizations listed by the AHJ at the controlling NASA center.

d. Cool Down of Cryogenic Systems.

- (1) During a cool down, cryogenic systems can experience large circumferential and radial temperature gradients that give rise to stresses not present during steady-state operation. Liquid flow cools a pipe faster than comparable gas flow, and the possibility exists for nonuniform cooling of pipes when two-phase flow occurs.

- (2) The largest circumferential temperature gradients, and consequently the highest added stresses, occur during stratified two-phase flow. Stratified two-phase flow occurs when liquid flows along the bottom or outer radius of a pipe or bend, and gas flows along the top or inner radius. Such conditions have caused significant pipe bowing in large cryogenic systems. Stratified flow has been found to decrease with increasing flow rate. During cool down, a minimum flow rate should be maintained to avoid pipe bowing.
- (3) Too rapid cooling can also cause large radial temperature gradients by quickly cooling the inner wall of sections, such as thick-walled flanges, while the outer wall remains near ambient temperature. Appendix B, Example 9 analyzes the temperature gradient that may occur in these operations.
- (4) It is recommended that cool down be accomplished by introducing a cold gas into the pipe, as from a vaporizer, instead of a liquid. Cooling with cold gas is always recommended for large cryogenic systems. Another alternative is the liquid soak, in which a small amount of cryogenic liquid is introduced into a limited portion of the piping system and allowed to evaporate under very low- or no-flow conditions so cooling occurs mostly by means of cold gas.
- (5) The margin of safety between the recommended cool down safe-flow limits and the limits at which pipe failure will occur is not well established, but operation of large systems within recommended limits has verified their safety.
- (6) Quantitative guides have been developed to maintain circumferential and radial temperature gradients within proven safe limits throughout cool-down for particular cryogenic liquids contained in horizontal pipes of particular common materials. The following guides to safe cool down rates should be followed:
 - (a) Thermal stress problems on cooldown are most likely in long ($L/D > 100$), thick-wall pipes with thick flanges.
 - (b) Figure A4.4 shows the minimum LH₂ and LN₂ flow rates that must be maintained to avoid wave or stratified flow up to a given fraction of completion of the vaporization process (Liebenberg, et al. 1967).

- (c) Figure A4.5 shows the maximum LH₂ and LN₂ flow rates to avoid excessive thermal stress from rapid cooling of the thick-wall piping sections such as flanges (Novak 1970).
- (d) A steady cooldown flow rate of LH₂ or LN₂ that not only avoids stratified flow but keeps the maximum cooldown stress within the allowable stress range may not be possible for pipelines and flanges of certain sizes and materials. A pipeline in which this condition exists may be precooled with gas or slugs of liquid (Novak 1970).

Appendix B, Example 9 examines flow rates during cool-down.

- (7) An optional method of preparing a warm vessel or system to receive LH₂ uses LN₂ for precooling. The cooling process evaporates large amounts of the cooling liquid. This may become a hazard if the cooling liquid is hydrogen. Perform the following before LH₂ is introduced to the vessel or system.
 - (a) Evacuate the vessel or system to approximately 1.33 kPa (10 torr). A warm, inert gas pressure purge should be carefully planned as a special case if this vacuum cannot be tolerated.
 - (b) Introduce the LN₂ into the vessel or system, taking care to prevent air migration that will cause contamination. Care should be taken to consider the extra weight of LN₂ because of its density; more than a factor of ten greater than the density of LH₂.
 - (c) Allow ample time to obtain all of the cooling possible from the liquid and the cold gas. Drain off the remaining LN₂, and remove the nitrogen atmosphere by evacuating the vessel.

CHAPTER 8: TRANSPORTATION

Note: Standards and guidelines for the transportation of hydrogen are for the protection of people, buildings, roads, and equipment.

800 GENERAL

a. Public Thoroughfares.

Transportation of GH_2 or LH_2 on public thoroughfares is covered by Federal DOT (49 CFR 1995) and state transportation requirements. NASA operations for the transport of GH_2 or LH_2 shall adhere to these requirements. A brief summary of 49 CFR (1995) is provided in Appendix D.

b. NASA Properties.

Transportation of GH_2 or LH_2 on thoroughfares controlled by NASA is the responsibility of the AHJ at the controlling NASA center. Such transportation shall meet the appropriate federal and state labor standards and guidelines in addition to standards imposed by the AHJ at the controlling NASA center.

c. DOT Definitions.

Materials transport containers are described according to the following definitions developed by the DOT:

- (1) GH_2 is specified as a compressed gas (package shipping identification number UN 1049) with a hazard class of 2.1 (flammable gas) by DOT (49 CFR 172.101 1995 and 49 CFR 173.115 1995).
- (2) LH_2 is specified as a cryogenic liquid (package shipping identification number UN 1966) with a hazard class of 2.1 (flammable gas) by DOT (49 CFR 172.101 1995 and 49 CFR 173.115 1995).
- (3) Cargo tank (49 CFR 171.8 1995) is bulk packaging that meets the following criteria:

- (a) A tank primarily intended for the carriage of liquids or gases that includes appurtenances, reinforcements, fittings, and closures (for “tank”, see 49 CFR 178.345 1995, 49 CFR 178.337 1995, or 49 CFR 178.338 1995, as applicable).
 - (b) It is permanently attached to or forms a part of a motor vehicle; or is not permanently attached to a motor vehicle but, by reason of its size, construction, or attachment to a motor vehicle is loaded or unloaded without being removed from the motor vehicle.
 - (c) It is not fabricated under a specification for cylinders, portable tanks, tank cars, or multiunit tank car tanks.
- (4) A cylinder is a pressure vessel with a circular cross section designed for pressures greater than 275.7 kPa (40 psia) (49 CFR 171.8 1995).

801 TRANSPORT ON PUBLIC THOROUGHFARES

a. General.

While most NASA commerce on public thoroughfares involves commercial carriers, the responsibility for complying with federal and state transportation laws rests not only with them but also with the organizations that handle and receive hydrogen.

b. Training.

Personnel involved in handling, receiving, shipping, and transport of a hazardous material shall receive appropriate training (49 CFR 172.700 1995). NASA specific training can be obtained from the Hazardous Materials Coordinator, Transportation Branch, Lyndon B. Johnson Space Center, Houston, TX 77058, (713) 483-6509.

c. Emergency Response.

During all phases of transport, emergency response information is required at facilities where hazardous materials are loaded, stored, or handled (49 CFR 173.600 1995). Advanced planning for a variety of potentially hazardous and disastrous fires and explosions shall be undertaken with full realization that the first priority is reduction of risk to the lives of emergency personnel and bystanders. MSDSs

contain useful emergency response information and shall be available on site. NASA shipments of hydrogen are monitored by CHEMTREC at 1-800-424-9300. Other emergency information sources include the Dow Chemical USA Distribution Emergency Response System at 1-517-634-4400 and the Union Carbide Corporation Hazardous Emergency Leak Procedure (HELP) that provides information 24 hours a day at 1-304-744-3487.

d. Transport Requirements for GH₂.

49 CFR 172.101 (1995) and 49 CFR 173 (1995) give general requirements for the transport of GH₂.

- (1) Packaging must be labeled or placarded.
- (2) 49 CFR (1995) gives packaging requirements for the various GH₂ container types. Appendix D gives a summary of packaging sections of 49 CFR (1995).
- (3) GH₂ cannot be transported aboard passenger aircraft, railcars, or ships. Up to 150 kg are permitted aboard cargo aircraft. It may be stowed above or below deck aboard a cargo ship away from chlorine gas and living quarters in accordance with 49 CFR 172.101 (1995).

e. Transport Requirements for LH₂.

49 CFR 172.101 (1995) and 49 CFR 173 (1995) give general requirements for the transport of LH₂.

- (1) Packaging must be labeled or placarded.
- (2) 49 CFR (1995) gives packaging requirements for the various LH₂ container types. Appendix D gives a summary of packaging sections of 49 CFR (1995).
- (3) LH₂ is not permitted aboard passenger aircraft, passenger railcars, or cargo aircraft. It may be stowed only above deck on cargo ships away from living quarters in accordance with 49 CFR 172.101 (1995).

802 TRANSPORT ON SITE CONTROLLED THOROUGHFARE

a. Standard Commercial Operation on Site.

Federal and state transportation guidelines can be applied in lieu of special requirements on NASA controlled sites where conditions and requirements of use are similar to public thoroughfares.

b. Noncommercial Equipment and Special Operations.

Special equipment used for the transport of hydrogen shall meet federal and state labor requirements (29 CFR 1996) as well as additional requirements of the AHJ at the controlling NASA center.

c. Guidelines for the Design of Noncommercial Transport Equipment.

- (1) General guidelines. When applicable, standard hydrogen design practice must be used (Chapters 3, 4, and 5).
 - (a) The vessel design will be in accordance with accepted design practice (ASME BPVC (1995) and 49 CFR 178.338 1995).
 - (b) Redundant relief protection must be provided to the vessel and piping systems.
 - (c) The process piping should be protected from collision damage by undercarriage, hampers, or other structure. Process piping should be designed to be empty during transportation and shear downstream of the vessel isolation valve in the event of an accident.
 - (d) The vessel must be insulated such that the holding time is sufficient to prevent hydrogen venting while the vehicle is in motion.
 - (e) The trailer shall use a fail-safe emergency brake system.
- (2) Requirements for highway service. The design of noncommercial vehicles must comply with federal and state transportation guidelines (Section 801) for operation on public thoroughfares. Any cargo tank must meet highway standards for cargo tank design (49 CFR 178.338 1995 for cryogenic transport and 49 CFR 178.337 1995 for gas carriers).

d. General Operating Procedures.

The following guidelines apply to all hydrogen operations.

(1) General.

- (a) Areas shall be clear of nonessential personnel. Appropriate personnel protective equipment should be used. Maintenance of the necessary deluge systems shall be verified.
- (b) All equipment including transport system, transfer equipment, and facility shall be grounded.
- (c) It shall be verified that no flame-producing devices are located within the operational area. Spark-producing and electrical equipment within the operational area and not hazard-proof shall be turned off and locked out. All tools used shall comply with established safety requirements.
- (d) All vessel inlets and outlets, except safety relief devices, shall be marked to designate whether they are covered by vapor or liquid when the vessel is filled.
- (e) Transport containers shall be located over noncombustible surfaces when in operation.
- (f) It shall be verified that trailers are equipped with a dry-chemical fire extinguisher. The rating shall not be less than 10 BC.
- (g) Transfer must be stopped, and the leak must be repaired in the event of a hydrogen leak. Hydrogen sources should be isolated as quickly as possible in the event of a hydrogen fire.
- (h) The atmosphere shall be sampled for safe hydrogen limits (less than 25 percent of the LFL) before motor vehicles are permitted to operate within the control area.
- (i) Operational procedural checklists shall be used.

802d

- (2) Repair operations.
 - (a) The system shall be verified safe according to procedures described in Section 700e before any type of maintenance is attempted.
 - (b) Repairs, alterations, cleaning, or other operations performed in confined spaces in which hydrogen vapors or gases are likely to exist shall be in accordance with Section 700d. The personnel engaged in the operations shall be advised of the hazards that may be encountered, and an attendant shall be immediately available while the work is being performed to administer emergency rescue if necessary.
- (3) Venting operations.
 - (a) Facility venting should be used when possible.
 - (b) A safe location in the field, remote if possible, should be selected for venting. Consideration should be given to the wind direction so vented gas will be safely carried away.
 - (c) Boil-off gases from LH₂ can ignite in the cargo tank vent stack. Fire suppression should involve shutting off the hydrogen flow, when possible, by closing the vent valve. Helium flow can be applied to the vent stack discharge if available. The vent valve can be opened after the fire is out and the vent stack has cooled.

e. Inspection, Certification, and Recertification of Mobile Vessels.

Testing and certification of mobile vessels for GH₂ and for LH₂ shall be in accordance with 49 CFR 178.337 (1995) and 49 CFR 178.338 (1995), respectively. Recertification for mobile vessels shall be in accordance with 49 CFR 180.407 (1995).

803 TRANSPORTATION EMERGENCIES

a. Initial Actions.

The first concern shall be to prevent death or injury. Try to get the dewan off the road if possible preferably to an open location if an accident or emergency occurs. Shut-off the tractor-trailer electrical system. Post warning lights and signs and keep people at least 152 m (500 ft) away. Contact authorities and obtain help by calling the following:

- (1) On site. Call the number designated by the AHJ at the controlling NASA center.
- (2) Off site. Call CHEMTREC at 1-800-424-9300.

b. Emergency Actions.

Emergency actions to combat leaks and fires involving hydrogen tractor-trailers include pulling the vehicle into the least hazardous area and turning the ignition off. Parking the leaking tractor-trailer in an open area limits the possibility of partial confinement and decrease the chance of significant pressure rises should the mixture ignite. A fire extinguisher should be used for fires originating near the engine; water or chemical fire extinguishers should be used for tire fires. Tires may reignite 20 to 30 min after the initial fire has been extinguished; therefore, the driver should not leave the scene until the tire temperature is sufficiently lowered. The driver also should not leave the scene until the fire has been completely extinguished and the burning materials cooled. Aid should be requested from the nearest fire or police department. On the highway, the environment in which a fire and subsequent damage may occur is difficult to control. An accident may occur at any time and place along the route. A controlled release of hydrogen from the trailer through venting should take into account all possible ignition sources, vapor dispersion, population exposure, and general safe operations. Flares normally used for highway vehicular accident identification should not be used in close proximity to upset or damaged LH₂ vessels.

CHAPTER 9: EMERGENCY PROCEDURES

Note: An emergency action plan shall be developed and implemented.

900 GENERAL

An emergency action plan shall be developed and implemented. The emergency action plan shall be in writing and shall cover those designated actions employers and employees must take to ensure employee safety from fire and other emergencies (29 CFR 1910.38 1996 and NMI 1040.3 1991)

a. General Elements.

The following elements, at a minimum, shall be included in the plan (29 CFR 1910.38 1996):

- (1) Emergency escape procedures and emergency escape route assignments
- (2) Procedures to be followed by employees who remain to operate critical plant operations before they evacuate
- (3) Procedures to account for all employees after emergency evacuation has been completed
- (4) Rescue and medical duties for those employees who are to perform them
- (5) The preferred means of reporting fires and other emergencies
- (6) Names and regular job titles of persons for further information or explanation of duties under the plan

b. NASA Specific Elements.

Plans shall be developed in accordance with QS-EPP-92-001. Emergency plans shall include procedures for the following situations (NSS 1740.11 1993):

- (1) Actions by initially responding personnel
- (2) Appropriate fire suppression response
- (3) Establishment and maintenance of communications

900b

- (4) Appropriate medical response
- (5) Summoning outside assistance
- (6) Establishing security
- (7) Possible media coverage
- (8) Salvage and restoration operations
- (9) Establishing a command post with a predesignated line of authority
- (10) Hazardous material inventory (29 CFR 1910.120 1996)
- (11) Asbestos

c. Alarm System.

The AHJ at the controlling NASA center shall establish an employee alarm system (29 CFR 1910.165 1996). A distinctive signal for each purpose shall be used if the employee alarm system is used for alerting fire brigade members or for other purposes (29 CFR 1910.38 1996).

d. Incident Management System.

Each AHJ at the controlling NASA center shall adopt and implement the Incident Management System (IMS) in accordance with NFPA 1561 (1995). The IMS shall be used when managing a disaster or emergency (NSS 1740.11 1993).

e. Incident Command System.

The senior emergency response official responding to an emergency shall become the individual in charge of a site specific Incident Command System (ICS). All emergency responders and their communications shall be coordinated and controlled through the individual in charge of the ICS assisted by the senior official present for each employer (29 CFR 1910.120 1996).

f. Training.

The AHJ at the controlling NASA center shall designate and train a sufficient number of persons to assist in the safe and orderly emergency evacuation of employees before implementing the

emergency action plan. The AHJ at the controlling NASA center shall review the plan at the following times (29 CFR 1910.38 1996):

- (1) During initial plan development
- (2) During changes in employee responsibilities or designated actions under the plan
- (3) During plan changes.

902 TYPES OF EMERGENCIES

a. General.

- (1) The principal danger from a leak or spill is the potential for cryogenic burns and fires. Ventilation of storage, transfer, and use areas and the avoidance of ignition sources helps reduce the danger of fire.
- (2) Trucks, automobiles, or tank cars shall not be allowed through the area when spills occur, until the AHJ at the controlling NASA center has certified the area to be safe for operations. The area shall be completely roped off and signs shall be posted. A person shall be stationed in a safe location upwind to warn others of danger if rope or signs are not available.
- (3) The source of supply shall be immediately shut off when a liquid leak or spill occurs in the piping from a vessel or a pumping system. The system can be disassembled, and the leak can be repaired after the equipment or piping has been thoroughly vented and purged.
- (4) Catastrophic fires can be prevented by training personnel in their duties. It is important to remember that if the fire is extinguished without stopping the gas flow, an explosive mixture may form, making a more serious hazard than the fire itself. The approach generally should be to prevent the fire from spreading and let it burn until the hydrogen is consumed.
- (5) High-pressure GH₂ leaks are more frequently heard than seen. Operations shall be immediately stopped, the supply source shall be isolated from the leaking system, and the line (or the system) shall be relieved of any pressure as soon as leaks are noted. Operations shall resume only after the repairs are completed.

901b

b. Controllable Leaks.

Controllable leaks are relatively small leaks that would not result in significant spill quantity before block, shut-off, and relief valves can be made operational. The AHJ at the controlling NASA center is responsible for establishing procedures for small GH₂ leaks when such leaks have been shown to present no hazard to personnel, equipment, or facilities.

c. Uncontrollable Leaks.

Uncontrollable leaks may be large and involve major spills. Actions to be taken shall be directed to the safety of personnel. Fires and explosions may develop. Procedures to be followed include the following:

- (1) The supply source shall be shut off if possible.
- (2) The area shall be evacuated to 152 m (500 ft) from the spill source.
- (3) Safety and fire departments shall be notified.
- (4) Adjacent equipment shall be cooled down in case of fire.

d. Handling Gas Leaks from Cylinders.

- (1) Only an acceptable, approved solution shall be used when testing for leaks.
- (2) If a cylinder safety device leaks, personnel shall not attempt to correct the leak by tightening the safety device cap while the cylinder is under pressure. The contents of the cylinder shall be emptied in a safe location. The cap shall be removed to examine the condition of the threads, correct the damage, and pressurize and leak test.
- (3) Leaking commercial cylinders should be safely vented, tagged as defective, and returned to the supplier.

e. Handling Cylinder Fires.

- (1) Personnel shall not try to put a fire out unless the cylinder is in the open or in a well-ventilated area free of combustibles and ignition sources. Extreme care should be taken in attempting to extinguish the fire. The process may create a

mixture of air and escaping hydrogen that, if reignited, might explode.

- (2) In most instances, personnel shall not attempt to remove the burning cylinder, but the burning cylinder and any surrounding cylinders and combustibles should be kept cool by spraying them with water.
- (3) The hazard presented by the possibility of the flame increasing in size and intensity and the possibility of igniting other cylinders or combustibles shall be kept in mind when making the decision to move a burning cylinder.
- (4) When a group of cylinders is burning, it is extremely important that the persons fighting the fire do so from as great a distance as practicable. Personnel should be protected against the possibility of fragments or shrapnel should an explosion occur. The efforts of fire fighters in such instances should be directed toward keeping the cylinders cool and preventing adjacent equipment and buildings from catching fire.

f. Hydrogen Spills.

Experiments were recently completed on the dispersion of flammable clouds resulting from large LH₂ spills. Such data are necessary for evaluating the safety of hydrogen systems and separation distances from buildings and roadways and developing satisfactory ignition and spill controls.

Note: Although they have not been tested, the data should apply to SLH₂ systems, except for the additional energy required to melt the solid particles.

- (1) Table A4.1 summarizes initial data obtained in experiments performed by A. D. Little, Inc. (1961) and by Zebetakis and Burgess (1961). Gas evolution rates measured with a gas meter were compared with calculated vaporization rates. Most of the A. D. Little, Inc. (1961) vaporization data were obtained from tests in a 0.6-m (2-ft) diameter, vacuum-insulated cylinder. Data for spills on sand and bank gravel exhibited an initial vaporization rate of 2.12 to 2.96 mm/s (5 to 7 in./min), decreasing to an apparently constant liquid regression rate of about 0.635 mm/s (1.5 in./min).

- (2) Experiments (Witcofsky and Chirivella 1982) provide basic information regarding the physical phenomena governing the dispersion of flammable clouds resulting from large LH₂ spills. The experiments consisted of ground spills of LH₂ as large as 5.7 m³ (1500 gal), with spill durations of approximately 35 s. Instrumented towers downwind of the spill site gathered data on the temperature, hydrogen concentration, and turbulence levels as the hydrogen vapor cloud drifted downwind. Visual phenomena were recorded by motion picture and still cameras. Results of the experiments indicate, for rapid spills, thermal and momentum-induced turbulences cause the cloud to disperse to safe concentration levels and to become positively buoyant long before mixing from normal atmospheric turbulence becomes a major factor. On the basis of the LH₂ spill quantities, rates, and modes reported and the limited data analyses conducted, the following conclusions were drawn:
- (a) Rapid LH₂ spills that might occur from a storage facility rupture are characterized by a brief period of ground-level flammable cloud travel during which the violent turbulence generated by the momentum of the spill, the quick phase change from a liquid to a vapor, and the thermal instability of the cloud cause the hydrogen vapors to mix quickly with air, disperse to nonflammable concentration, warm up, and become positively buoyant. The ground-level cloud travels approximately 50 to 100 m (164 to 328 ft) and then rises at 0.5 to 1.0 m/s (1.64 to 3.28 ft/s).
 - (b) Prolonged, gentle spills or spills that might occur from an LH₂ pipeline rupture are characterized by prolonged ground-level cloud travel. Ground-level cloud travel is prolonged by low spill or momentum-induced cloud turbulence and suspected to be aggravated by long-term ground cooling; the major heat transfer mechanism for determining the vaporization rate.
 - (c) The experiments show that the use of dikes around LH₂ storage facilities probably prolong ground-level flammable cloud travel and that it may be preferable not to use dikes and take advantage of the dispersion mechanisms provided by spill and vaporization-induced turbulence.

902 ASSISTANCE IN EMERGENCIES

Responsible safety personnel shall monitor the operations to ensure all safety precautions are taken during transfer, loading, testing, and disposal operations. Assistance in any emergency shall be available from those knowledgeable of safety and trained to deal with such an emergency.

a. Fire and Police Departments.

- (1) Fire department personnel shall be informed of the operations to be undertaken and when they will begin. Fire department assistance in an emergency shall be under the direction of the senior fire-fighting officer.
- (2) Fire fighters and police who respond to a spill, fire, or vehicle collision should be familiar with the hazard information cards recommended by the DOT or other safety documents (NHB 2710.1 1982). They should also know the recommended exclusion areas to protect the public if a spill or fire occurs. An additional factor for increased safety is awareness of fragment evacuation distance criteria. Guidance should be provided to limit danger from fragments and reduce the probability of injuries or fatalities in explosions.

b. Site Personnel.

Site personnel, trained in handling specific mishaps and accidents, may be assigned definite tasks to perform in an emergency. These tasks shall be assigned by the AHJ at the controlling NASA center.

c. Security.

Security personnel shall be informed of actions to be undertaken and prepared to assist in an emergency.

903 FIRE SUPPRESSION

Note: Hydrogen fires normally are not extinguished until the supply of hydrogen has been shut off because of the danger of reignition and explosion.

a. General.

- (1) There are many critical areas within NASA Field Installations where the occurrence of a fire or other related mishap demands a unique response from workers in the area, the safety organization, the security or police force, and responding fire fighters or emergency medical technicians. Existing routine procedures may not reflect the occurrence of such events or prove useful in structuring an effective response. Comprehensive planning for response to emergency situations shall be undertaken after a thorough analysis of the potential hazards. See NMI 1040.3 (1991), 29 CFR 1910.38 (1996), 29 CFR 1910.120 (1996), and 29 CFR 1910.156 (1996) (NSS 1740.11 1993).
- (2) Fire extinguishing equipment meeting the requirements of 29 CFR 1910.120 (1996) shall be on hand for ready use to control incipient fires.
- (3) Section 408 describes the design and installation of fixed fire suppression systems.
- (4) Employees, other than trained professional firefighters, trained volunteers, or emergency response personnel, shall not fight fires except in cases in which the fire is incipient in nature (NHB 1700.1 1993).
- (5) The only positive way of handling a hydrogen fire is to let it burn under control until the hydrogen flow can be stopped. A hazardous combustible mixture starts forming at once if the hydrogen fire is extinguished and the hydrogen flow is not stopped. It is very possible that the mixture will ignite with an explosion to cause more damage and restart the fire.
- (6) Although the hydrogen fire should not be extinguished until the hydrogen flow can be stopped, water sprays, etc., shall be used to extinguish any secondary fire and prevent the spread of the fire. The hydrogen-containing equipment should be kept cool by water sprays to decrease the rate of hydrogen leakage and prevent further heat damage.
- (7) Carbon dioxide may be used in the presence of hydrogen fires. Although some toxic carbon monoxide may be produced in the flame, it will not be a large amount. Anyone breathing in the hot flame gases will be affected in any case, regardless of the presence of carbon monoxide. The carbon monoxide will be

down to tolerable levels by the time the flame gases are diluted with fresh air and reach breathable temperatures. Confined spaces shall be well ventilated and verified as safe as described in Section 403d before they are entered, unless the appropriate protective apparatus are being used. Dry chemicals are better than carbon dioxide because they make the flames visible.

- (8) Remotely-controlled water-spray equipment, if it has been installed, should be used instead of hoses to cool equipment and reduce the spread of fire. If it is necessary to use hoses, personnel using them shall stay behind protective structures.

b. Actions Against GH₂ Fires.

- (1) Actions against GH₂ fires shall be in accordance with emergency action plans, including supervision as directed by the ICS.
- (2) The GH₂ supply shall be isolated if possible. Hydrogen systems shall be designed to stop the gas flow in an emergency.
- (3) Fog and solid-stream nozzles are the most adaptable in controlling fires. Dry-chemical extinguishers, carbon dioxide, nitrogen, and steam extinguish small hydrogen fires.
- (4) Water shall be sprayed on adjacent equipment to cool it as necessary.

c. Actions Against LH₂ Fires.

- (1) Actions against LH₂ fires shall be in accordance with emergency action plans, including supervision as directed by the ICS.
- (2) The LH₂ supply shall be isolated if possible. Hydrogen systems shall be designed to stop the liquid flow in an emergency.
- (3) Care shall be taken to prevent spraying water on or into vent openings when using water to suppress LH₂ fires (NFPA 50B 1994).

- (4) Water shall not be applied if the inner surface is exposed.
- (5) The only action in case of the ignition of a massive LH₂ spill is to keep adjacent equipment and facilities cool by spraying them with water.

904 FIRST-AID PROCEDURES FOR CRYOGENIC-INDUCED INJURIES

Note: This information represents the most current NASA Headquarters procedure on cold injuries. It may change, and anyone dealing with cryogenic hydrogen systems should keep informed on the latest recommended procedures.

a. General.

Direct physical contact with LH₂, cold vapor, or cold equipment can cause serious tissue damage. Momentary contact with a small amount of the liquid may not pose as great a danger of a burn because a protective film may form. Danger of freezing occurs when large amounts are spilled and exposure is extensive. Cardiac malfunctions are likely when the internal body temperature drops to 300 K (80.2 °F), and death may result when the internal body temperature drops to 298 K (76.4 °F).

b. Medical Assistance.

Medical assistance should be obtained as soon as possible. Treatment of truly frozen tissue requires medical supervision because incorrect first aid practices invariably aggravate the injury.

- (1) It is safest in the field to do nothing other than to protect the involved area with a loose cover. Transport the injured person to a medical facility if directed.
- (2) Attempts to administer first aid are often harmful. The following are important things to remember:
 - (a) Frozen gloves, shoes, or clothing shall not be removed except in a slow, careful manner, because the skin may be pulled off. Unremoved clothing can easily be put into a warm water bath.
 - (b) The affected part shall not be massaged.

- (c) The affected part shall not be exposed to temperatures higher than 318 K (112 °F). Exposure to warm temperatures superimposes a burn, and gravely damages already injured tissues.
- (d) Water outside the temperature range of 311 K to 318 K (100 °F to 112 °F) shall not be applied to expose the affected part.
- (e) Safety showers, eyewash fountains, or other sources of water shall not be used, because the temperature will almost certainly be therapeutically incorrect and aggravate the injury. Safety showers shall be tagged, NOT TO BE USED FOR TREATMENT OF CRYOGENIC BURNS.
- (f) Snow or ice shall not be applied.
- (g) Ointments shall not be applied.

c. Training.

Education of the risk of cold injury as well as preventive and emergency care must be incorporated into training programs for operations and emergency response.

905 SAFEGUARDS FOR ENTERING PERMIT-REQUIRED CONFINED SPACES

- a. Personnel entering a confined space that may be subject to oxygen enrichment, oxygen depletion, toxic chemicals, or hydrogen gas shall follow approved practices and procedures (29 CFR 1910.146 1996).
- b. Acceptable entry conditions that must exist in a permit space to allow entry follow:
 - (1) Oxygen content shall be between 19.5 percent by volume and 23.5 percent by volume, otherwise appropriate breathing apparatus shall be used.
 - (2) Hydrogen content shall be less than 10 percent of LFL (less than 0.4 percent by volume).

905b

- (3) Atmospheric concentrations of any substance that may expose personnel to risk of death, incapacitation, impairment of ability to self-rescue, injury, or acute illness shall be below the limits established in 29 CFR (1996).
- c. Personnel entering permit-required confined spaces shall have an attendant present and area life-line or other approved safety removal equipment as required.
 - d. The internal atmosphere shall be tested, before personnel enter permit-required confined spaces, with a calibrated direct reading instrument for the following conditions in the order given:
 - (1) Oxygen content
 - (2) Flammable GH₂ gases and vapors
 - (3) Potential toxic air contaminants

CHAPTER 10: REFERENCES

- A. D. Little, Inc. *Final Report, Electrostatic Hazards Associated with the Transfer and Storage of Liquid Hydrogen*. A. D. Little report to the Agena and Centaur Systems Office, Marshall Space Flight Center, NASA, Huntsville, AL, May (1961).
- API 620. *Design and Construction of Large, Welded, Low-Pressure, Storage Tanks, API Standard 620, 8th Edition*. American Petroleum Institute, Washington, DC, June (1990).
- AMCP-706-180. *Engineering Design Handbook, Principles of Explosive Behavior*. Army Materiel Command, Alexandria, VA, April (1972).
- ANSI/ASME A13.1. *Scheme for Identification of Piping Systems*. American Society of Mechanical Engineers, New York, NY (1981).
- ANSI/ASME B31.1. *Power Piping*. National Standard Code for Pressure Piping American Society of Mechanical Engineers, New York, NY (1995).
- ANSI/ASME B31.3. *Process Piping*. American Society of Mechanical Engineers, New York, NY (1996).
- ANSI/ASME B31.8. *Gas Transmission and Distribution Piping Systems*, American Society of Mechanical Engineers, New York, NY (1986).
- ANSI/IEEE Std 268. *American National Standard for Metric Practice*, Institute of Electrical and Electronics Engineers, New York, NY (1992).
- ANSI/UL 913. *UL Standard for Intrinsically Safe Apparatus and Associated Apparatus for Use in Class I, UL II, and III, Division 1 Hazardous Locations*. National Fire Protection Association, Inc., New York, NY (1988, 1993 and 1996 updates).
- ASME. *ASME Boiler and Pressure Vessel Code, Section V, Nondestructive Examination*. American Society of Mechanical Engineers, New York, NY (1995).
- ASME. *ASME Boiler and Pressure Vessel Code, Section VIII, Rules for Construction of Pressure Vessels, Division 1*. American Society of Mechanical Engineers, New York, NY (1995).
- ASME. *ASME Boiler and Pressure Vessel Code, Section IX, Welding and Brazing Qualifications Procedures*. American Society of Mechanical Engineers, New York, NY (1995).

- ASTM F310-70. *Standard Practice for Sampling Cryogenic Aerospace Fluids*. American Society for Testing Materials, Philadelphia, PA (1980).
- Baker, W. E., J. J. Kulesz, R. F. Ricker, P. S. Westine, V. B. Parr, I. M. Vargas, and P. K. Moseley. *Workbook for Estimating Effects of Accidental Explosions in Propellant Ground Handling and Transport Systems*. NASA CR-3023, NASA (1978).
- Beach, R. "Preventing Static Electricity Fires." *Chemical Engineering*, Volume 71, No. 26 (December 21, 1964): pp. 73-78; Vol. 72, No. 1 (January 4, 1965): pp. 63-66; Vol. 72, No. 3 (February 1, 1965): pp. 85-88.
- Benz, F. J., C. V. Bishop, and M. D. Pedley. *Ignition and Thermal Hazards of Selected Aerospace Fluids: Overview, Data, and Procedures*. NASA White Sands Test Facility, Las Cruces, NM, October (1988).
- Benz, F. J. and P. L. Boucher. "Flammability Characteristics of Hydrogen/Oxygen/Nitrogen Mixtures at Reduced Pressures." *Workshop on the Impact of Hydrogen on Water Reactor Safety*. Vol. 3, M. Berman, Ed., SAND 81-0661-VOL-3, Albuquerque, NM (1981).
- Brown, L. E., H. R. Wesson, and J. R. Welker. "Predict LNG Fire Radiation." *Hydrocarbon Processing*, Vol. 53, No. 5 (May 1974): pp. 141-143.
- Bull D. C., J. E. Ellworth, and P. J. Shiff. "Detonation Cell Structures in Fuel/Air Mixtures." *Combustion and Flame*, Vol. 45, No. 1 (1982): pp. 7-22.
- Bunker, R.L, J. Dees, and M. Eck. *Large Scale Hydrogen/Oxygen Explosion Project*. Special Interim Test Data Report, NASA White Sands Test Facility, WSTF # 95-28791, Las Cruces, NM, January 5, 1995.
- Buettner, K. "Effects of Extreme Heat and Cold on Human Skin, II, Surface Temperatures, Plain and Heat Conductivity in Experiments with Radiant Heat." *Journal of Applied Physiology*, Vol. 3 (1951): pp. 703-713.
- Burgess, D., et al. "Volume of Flammable Mixture Resulting from the Atmospheric Dispersion of a Leak or Spill." *Proceedings of the Fifteenth Symposium (International) on Combustion*. Combustion Institute, Pittsburgh, PA (1975): pp. 289-303.
- CFR Title 29. *Occupational Health and Safety Standards*. Code of Federal Regulations. Part 1910, Sects. 38, 103, 106, 119, 120, 132, 133, 134, 146, 156, 165, 1027, (latest revision).
- CFR Title 49. *Transportation*. Code of Federal Regulations. Parts 171, 172, 173, 177, 178, 180, Sects. 171.8, 172.101, 173.31, 173.33, 173.115, 173.302, 173.306, 173.315, 173.316, 173.318, 177.840, 178.36, 178.33-1, 178.33-7, 178.33-8, 178.345-7, 180.407 (latest revision).

- CGA G-5.4. *Standard for Hydrogen Piping Systems at Consumer Locations*. Compressed Gas Association. Arlington, VA (1992).
- CGA S-1.1. *Pressure Relief Device Standards - Part 1-Cylinders for Compressed Gases*. Compressed Gas Association. Pamphlet S-1.1-1995. Arlington, VA (1995).
- CGA S-1.2. *Pressure Relief Device Standards - Part 2-Cargo and Portable Tanks for Compressed Gases*. Compressed Gas Association. Pamphlet S-1.2-1995. Arlington, VA (1995).
- CGA S-1.3. *Pressure Relief Device Standards - Part 3-Compressed Gas Storage Containers*. Compressed Gas Association, Pamphlet S-1.3-1995. Arlington, VA (1995).
- CGA V-6. *Standard Cryogenic Liquid Transfer Connections, CGA Pamphlet V-6*. Compressed Gas Association, Arlington, VA 1993.
- Cloyd, D. R. and W.J. Murphy. *Handling Hazardous Materials*. NASA SP-5032, National Aeronautics and Space Administration, Washington DC, September (1965).
- DoD 6055.9. *Ammunition and Explosives Safety Standards*. Department of Defense, 1992.
- Edeskuty F. J. and W. F. Stewart. *Safety in the Handling of Cryogenic Fluids*. Plenum Press, New York, NY (1996).
- Gordon S, and B. J. McBride. *Computer Program for Calculation of Complex Chemical Equilibrium Compositions and Applications*. NASA Reference Publication 1311, October (1994).
- Hertzberg, M. and C. D. Litton. *Flammability Limits and Pressure Development in Hydrogen-Air Mixtures*. PRC Report No. 4305, Pittsburgh Research Center, Pittsburgh, PA, January (1981).
- Kent, G. R. "Find Radiation Effect of Flares." *Hydrocarbon Processing*, Vol. 47, No. 6, Section 1 (June 1968): pp. 119-130.
- KHB 1710.2A(V2). *KSC Safety Practices Handbook, Volume 2 - Safety Operating Procedures, No. 41 - Pressure System Safety*. Rev. A, NASA Kennedy Space Center, FL, May 25 (1983).
- KSC-STD-E-0002. *Standard for Hazard Proofing of Electrically Energized Equipment*. Rev. A, NASA Kennedy Space Center, FL, August (1976).
- KSC-STD-Z2-0009. *Standard for Design of Cryogenic Ground Support Equipment*. NASA Kennedy Space Center, FL, June (1973).

- KSC-SPEC-Z-0020. *Specification for Welding of Aerospace Ground Support Equipment and Related Facilities*. NASA Kennedy Space Center, FL (1995).
- Lee, John H. S. "Initiation of Gaseous Detonation." *Annual Review of Physical Chemistry*, Vol. 28 (1977): pp. 75-104.
- Lee, John H. S., R. Knystautas, C. M. Guirao, W. A. Benedict, and J.E. Shepherd. *Hydrogen-Air Detonations*. Sandia National Laboratories, Albuquerque, NM (1982).
- Lewis B. and G. von Elbe. *Combustion, Flames and Explosion of Gases, 2nd Ed.*. New York Academic Press, New York, NY (1961).
- McClintock, R. M. and H. P. Gibbons. *Mechanical Properties of Structural Materials at Low Temperature, a Compilation from the Literature, National Bureau of Standards Monograph 13*. United States Department of Commerce, Washington, DC (1960).
- McPherson, W. B. Private Communication (1995).
- MIL-C-81302. *Military Specification, Cleaning, Compound Solvent, Trichlorotrifluoroethane*, Revision D (1991).
- MIL-P-27201. *Military Specification, Propellant Hydrogen, Revision B*. U. S. Air Force, 30 June (1971).
- MIL-STD-1522A. *Military Standard, Standard General Requirements for Safe Design and Operation of Pressurized Missile and Space Systems, Revision A*. United States Air Force, 1984.
- Moore, et al. *NASA Lewis Hydrogen Safety Manual*. NASA Lewis Research Center, Cleveland, OH, December, 10 (1959).
- Mills, J. C., L. J. Linley, and D. L. Phippen. *Lower Flammability Limits of Hydrogen in Air at Reduced Pressures*. TR-205-001, NASA White Sands Test Facility, Las Cruces, NM, April (1977).
- NASA LeRC. *Lewis Operational Safety Manual*. "Chapter 10: Rocket Propellant." NASA Lewis Research Center, Cleveland, OH, February (1967).
- NASA TM 104438. *Lewis Safety Manual, Chapter 6, Hydrogen Propellant*. Cleveland, OH (1992).
- NASA TM X-52454. *Hydrogen Safety Manual*. NASA Lewis Research Center, Cleveland, OH (1968).

- NFPA 15. *Standard for Water Spray Fixed Systems for Fire Protection*. National Fire Protection Association, Quincy, MA (1996).
- NFPA 50A. *Standard for Gaseous Hydrogen Systems at Consumer Sites*. National Fire Protection Association, Inc., Quincy, MA (1994).
- NFPA 50B. *Standard for Liquefied Hydrogen Systems at Consumer Sites*. National Fire Protection Association, Inc., Quincy, MA (1994).
- NFPA 68. *Guide for Explosion Venting of Deflagrations*. National Fire Protection Association, Inc., Quincy, MA (1994).
- NFPA 69. *Standard for Explosion Prevention Systems*. National Fire Protection Association, Inc., Quincy, MA (1992).
- NFPA 70. *National Electric Code (NEC)*. National Fire Protection Association, Inc., Quincy, MA (1993).
- NFPA 496. *Standard for Purged Enclosures for Electrical Equipment in Hazardous (Classified) Areas*. National Fire Protection Association, Inc., Quincy, MA (1982).
- NFPA 780. *Standard for Installation of Lightning Protection Systems*. National Fire Protection Association, Inc., Quincy, MA (1995).
- NFPA 1561. *Standard on Fire Department Incident Management System*. National Fire Protection Association, Inc., Quincy, MA, August (1995).
- NHB 1700.1. *NASA Basic Safety Manual*. Volume 1-A; Vol 1-B, National Aeronautics and Space Administration, Washington, DC (1993).
- NHB 1700.6. *Guide for Inservice Inspection of Ground-Based Pressure Vessels and Systems*. National Aeronautics and Space Administration, Washington, DC, January (1976).
- NHB 2710.1. *Safety and Health Handbook - Occupational Safety and Health Programs*. NASA TM-84718, Washington, DC (1982).
- NHB 7320.1. *NASA Facilities Engineering Handbook, Revision B*. National Aeronautics and Space Administration, Washington, DC (1982).
- NHS/IH 1845.2. *NASA Health Standard for Entry Into and Work in Confined Spaces*. (1983).
- NMI 1040.3. *NASA Management Instruction, Emergency Preparedness Program, Revision C*. National Aeronautics and Space Administration, July (1991).

- NMI 1710.1. *NASA Management Instruction, Safety Program for Pressure Vessels and Pressurized Systems, Revision D*. National Aeronautics and Space Administration, Washington, DC, February (1994).
- NMI 8621.1. *Mishap Reporting and Investigating*, NASA Management Instruction, Revision D, National Aeronautics and Space Administration, June (1983).
- NSS 1740.11. *NASA Safety Standard for Fire Protection*. National Aeronautics and Space Administration, Office of Safety and Mission Assurance, Washington, DC, August (1993).
- NSS 1740.12. *NASA Safety Standard for Explosives, Propellants, and Pyrotechnics*. National Aeronautics and Space Administration, Washington, DC, (1993).
- NSS 1740.15. *NASA Safety Standard for Oxygen and Oxygen Systems*. Office of Safety and Mission Assurance, Washington, DC, January (1996, or latest revision).
- NSS/HP 1740.1. *NASA Aerospace Pressure Vessel Safety Standard*. National Aeronautics and Space Administration, Washington, DC, February (1974).
- NSS/HP 1740.4. *NASA Medium Weight Pressure Vessel Safety Standard*. National Aeronautics and Space Administration, Washington, DC, August (1976).
- O'Hanlon, J. F., *A User's Guide to Vacuum Technology*. John Wiley & Sons, New York (1980).
- Ordin, P. M. and R. C. Carter. *Clinch River Breeder Reactor Hydrogen Disposal and Ignition System*. ARSD-00093, General Electric, June (1980).
- Ordin, P. M. "A Review of Hydrogen Accidents and Incidents in NASA Operations." Proceedings in the *9th Intersociety Energy Conversion Engineering Conference*. American Society of Mechanical Engineers (1974): pp. 442-453.
- Perlee H. E., E. L. Litchfield, and M. G. Zabetakis. *Review of Fire and Explosion Hazards of Flight Vehicle Combustibles*. Annual Report No. 404, ASD-TR-61, Supplement 3, N64-28608; AD-602-481, Bureau of Mines, Pittsburgh, PA, June (1964).
- QS-EPP-92-001. *NASA Emergency Preparedness Plan*, National Aeronautics and Space Administration, Washington, DC, July (1992).
- Raj, P. and S. Atallah. "Thermal Radiation from LNG Spill Fires." *Advances in Cryogenic Engineering*, Vol. 20, K.D. Timmerhaus, Ed., Plenum Press, NY, (1975): pp. 143-150.

- Rosen, B., V. H. Dayan, and R. L. Proffitt. *Hydrogen Leaks and Fire Detection, A Survey*. NASA, Washington, DC (1970).
- Shepard J. E. and S. F. Roller. *Predictions of Detonability of Hydrogen-Air-Steam Mixtures*. SAND 82--2456, Albuquerque, NM (1982).
- Siegel, R. and J. R. Howell. *Thermal Radiation Heat Transfer, Volume 3 - Radiation Transfer With Absorbing, Emitting, and Scattering Media*. NASA SP-164-VOL-3, Washington, DC (1971).
- Smith, S. R. Ph.D. *Gas-Liquid Phase Equilibrium in the He-H₂ System*. Ohio State University, Columbus, OH (1952).
- Streett, W. B., R. E. Sonntag, and G. J. Van Wylen. "Liquid-Vapor Equilibrium in the System Normal Hydrogen-Helium." *Journal of Chemistry and Physics*, Vol. 40, No. 5 (March 1964): p. 1390.
- Swisher, J. H., S. C. Keaton, A. J. West, and A. T. Jones. *Survey of Hydrogen Compatibility Problems in Energy Storage and Energy Transmission Systems*. Sandia Laboratories Energy Report, SAND74-8219, Albuquerque, NM (1974).
- Thompson, J. D. and J. D. Enloe. "Flammability Limits of Hydrogen-Oxygen-Nitrogen Mixtures". *Combustion and Flame*, 1066, 10(4) (December 1996): pp. 393-394
- Van Dolah, R.W., et al. *Review of Fire and Explosion Hazards of Flight Vehicle Combustibles*. BM-IC-8137, Bureau of Mines, Pittsburgh, PA (1963).
- Webb, P. *Pain Limited Heat Exposures, Tissue Heating and Thermal Sensations*. Webb Associates, Yellow Springs, OH (1963).
- Willis, W. L. "Electrical Conductivity of Some Cryogenic Fluids." *Cryogenics*, Vol 6 (October 1966): pp. 279-284.
- Wionsky, S. G. "Predicting Flammable Material Classifications." *Chemical Engineering*, Vol. 79, No. 26 (November 27, 1972): pp. 81-86.
- Witcofsky, W. D. and J. E. Chirivella. "Experimental and Analytical Analyses of the Mechanisms Governing the Dispersion of Flammable Clouds Formed by Liquid Hydrogen Spills." *Hydrogen Energy Progress-IV*, T. N. Veziroglu, W. D. Van Vorst, and J. H. Kelley, Eds. Vol. 4, Pergamon Press, New York (1982): pp. 1659-1674.
- Zabetakis, M. G. and D. S. Burgess. *Research on the Hazards Associated With the Production and Handling of Liquid Hydrogen*. BM-RI-5707, Bureau of Mines Report of Investigation, Washington, DC (1961).
- Zabetakis, M. G. *Safety With Cryogenic Fluids*. Plenum Press, New York (1967).

APPENDIX A
TABLES AND FIGURES

A.1 HYDROGEN CHEMICAL AND PHYSICAL PROPERTIES

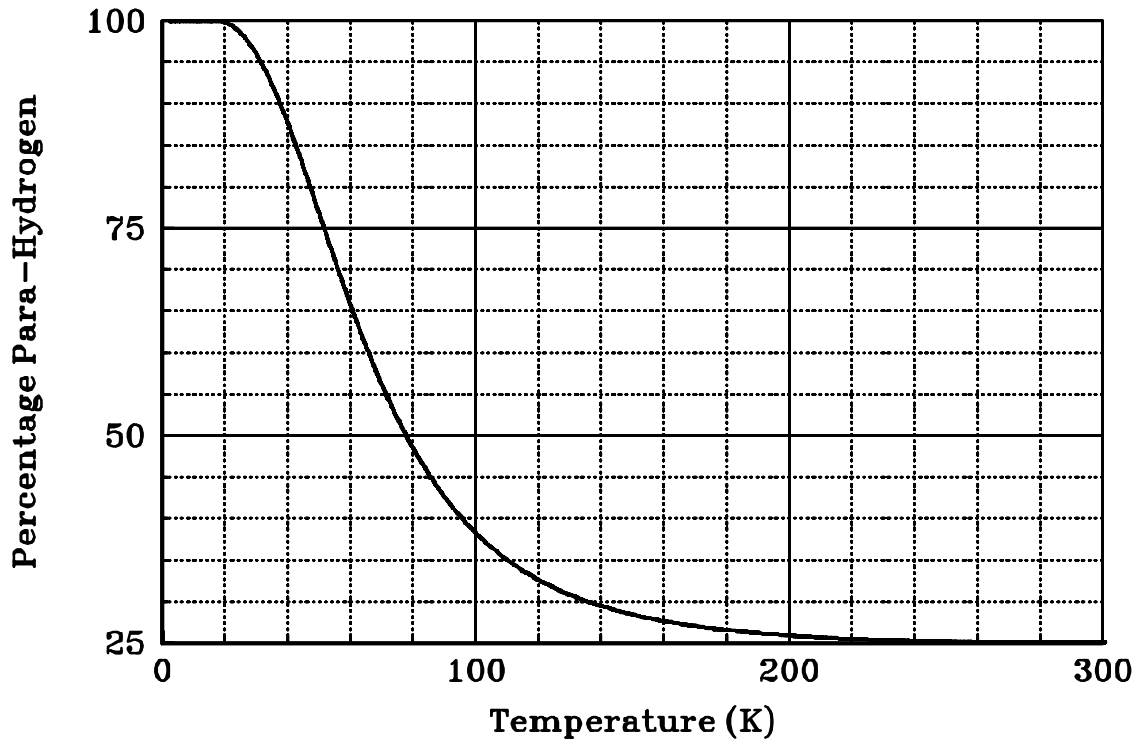

Figure A1.1
Equilibrium Percentage of Para-hydrogen vs. Temperature

Source:

McCarty, R. D., J. Hord, and H. M. Roder. *Selected Properties of Hydrogen (Engineering Design Data)*. NBS Monograph 168, National Bureau of Standards, Boulder, CO (1981).

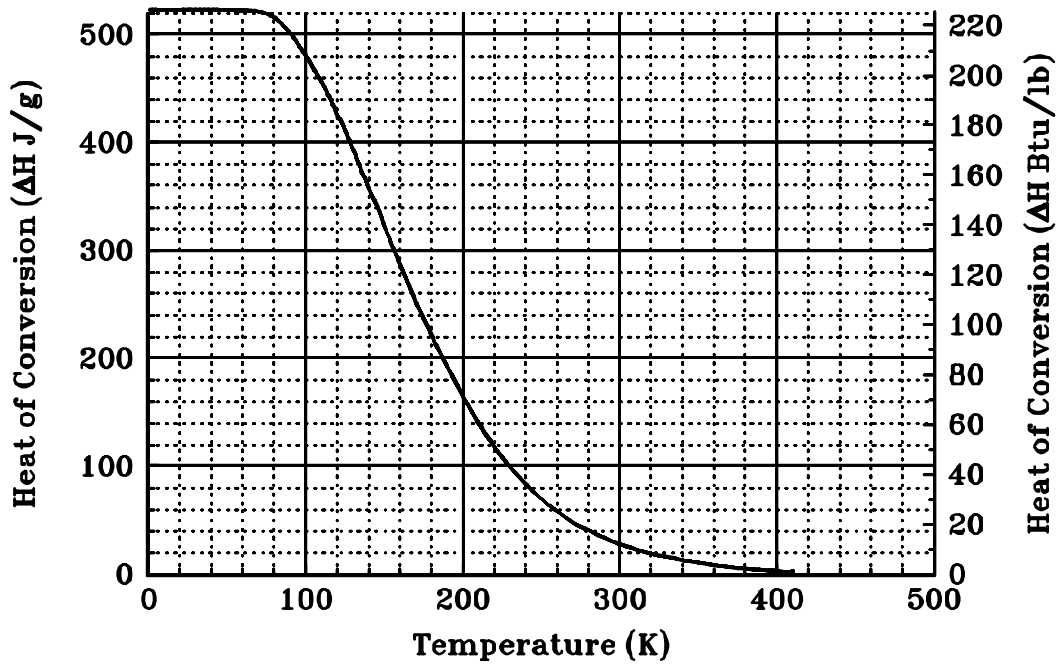

Figure A1.2
Enthalpy of Normal Hydrogen Conversion

Source:

McCarty, R. D., J. Hord, and H. M. Roder. *Selected Properties of Hydrogen (Engineering Design Data)*. NBS Monograph 168, National Bureau of Standards, Boulder, CO (1981).

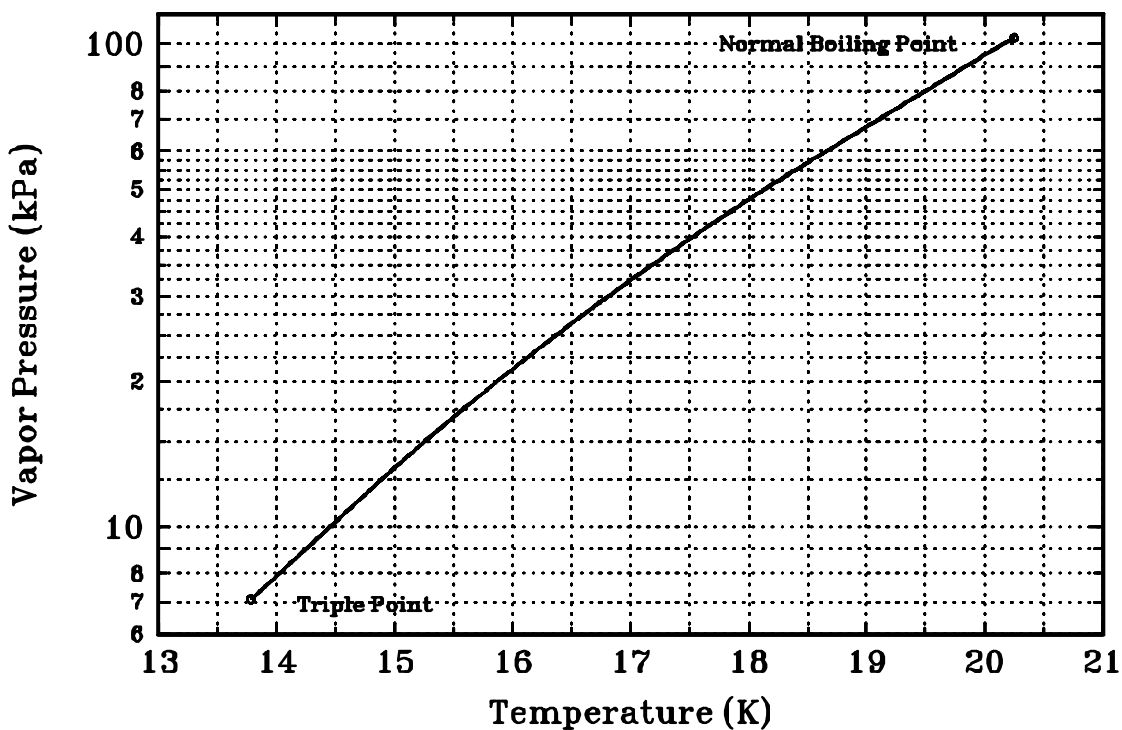

Figure A1.3
 Vapor Pressure of Liquefied Para-hydrogen (TP¹ to NBP²)

Source:

McCarty, R. D., J. Hord, and H. M. Roder. *Selected Properties of Hydrogen (Engineering Design Data)*. NBS Monograph 168, National Bureau of Standards, Boulder, CO (1981).

¹ TP = Triple Point

² NBP = Normal Boiling Point

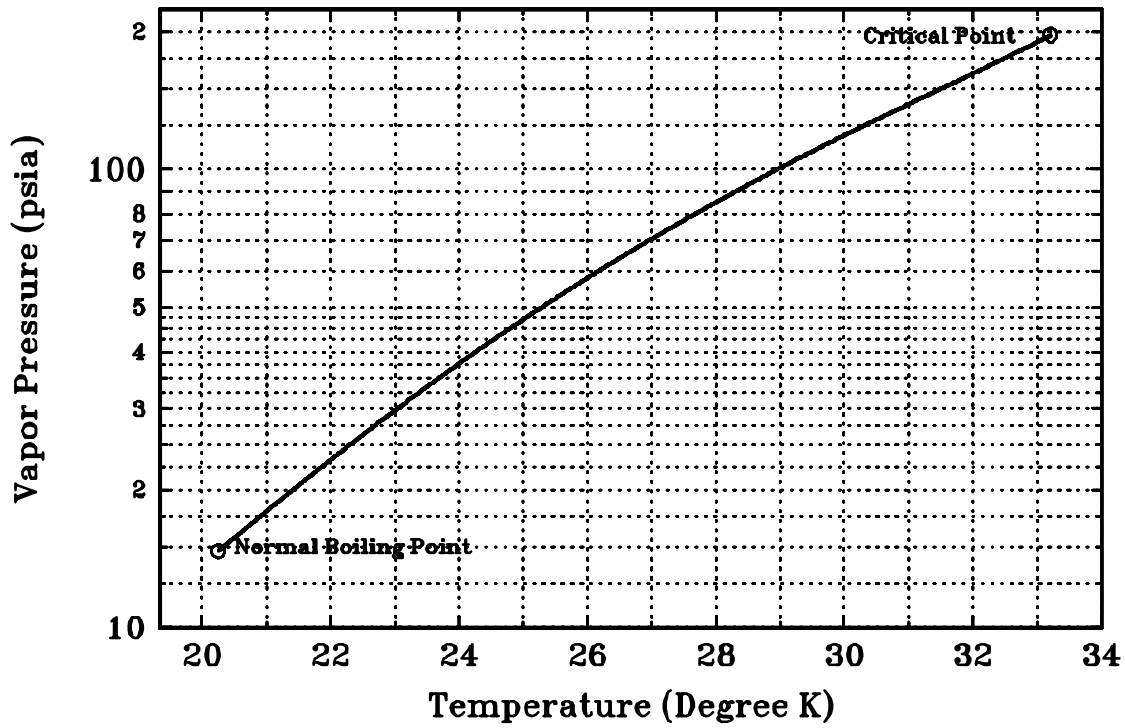

Figure A1.4
Vapor Pressure of LH₂ (NBP¹ to CP²)

Source:

McCarty, R. D., J. Hord, and H. M. Roder. *Selected Properties of Hydrogen (Engineering Design Data)*. NBS Monograph 168, National Bureau of Standards, Boulder, CO (1981).

¹ NBP = Normal Boiling Point

² CP = Critical Point

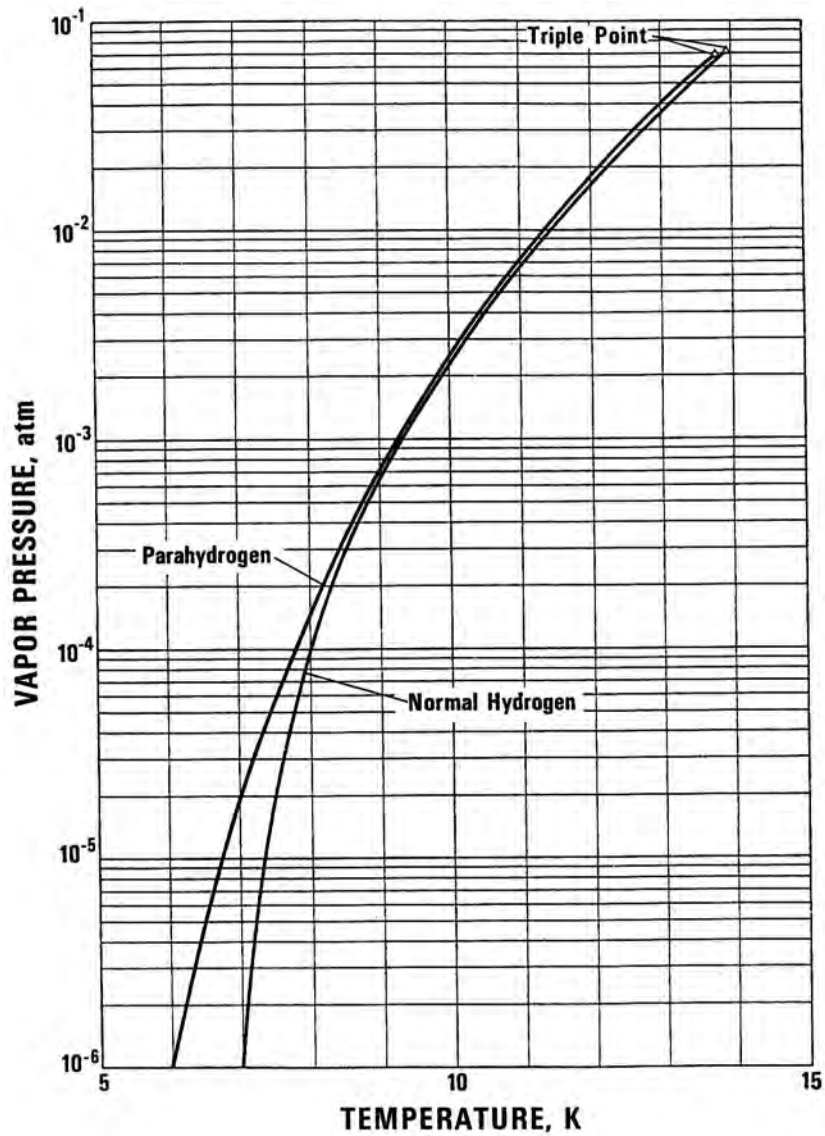

Figure A1.5
Vapor Pressures of Normal and Para-hydrogen Below the Triple Point

Source:

McCarty, R. D., J. Hord, and H. M. Roder. *Selected Properties of Hydrogen (Engineering Design Data)*. NBS Monograph 168, National Bureau of Standards, Boulder, CO (1981).

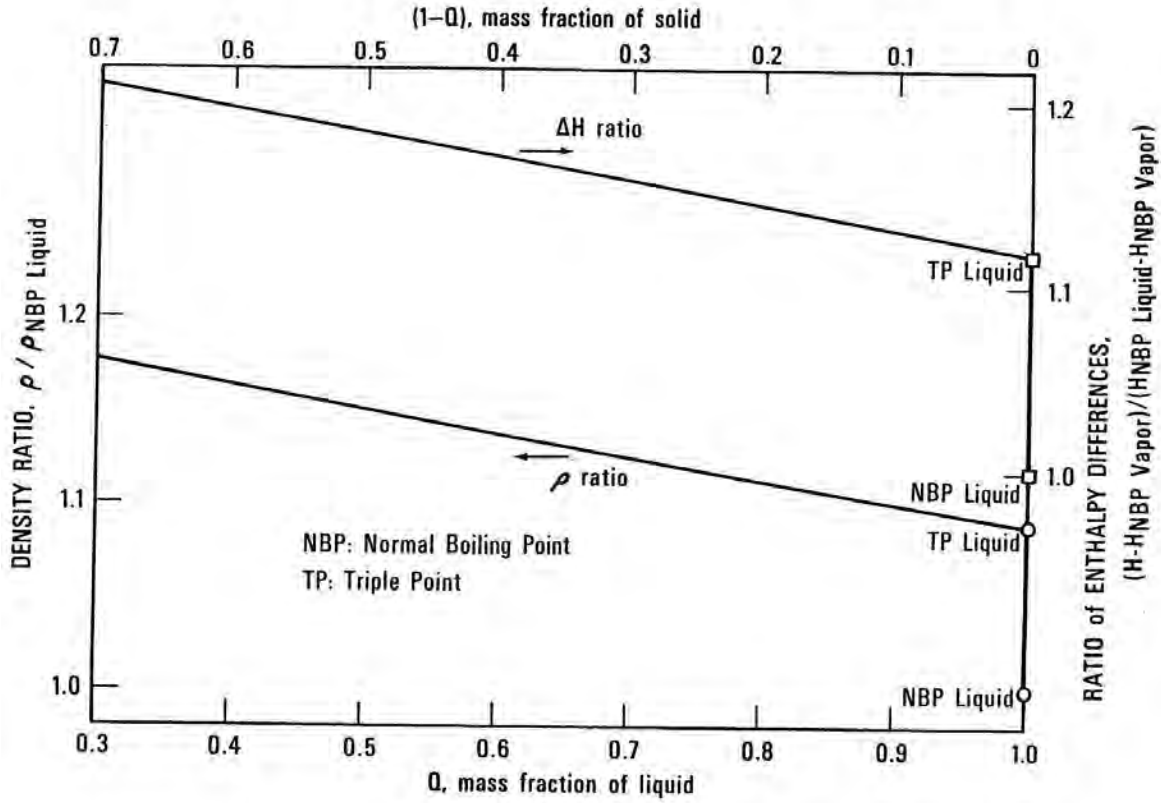

Figure A1.6
 Comparison of Densities and Bulk Fluid Heat Capacities for Slush, Triple-Point Liquid, and NBP¹ Liquid Para-hydrogen

Source:

McCarty, R. D., J. Hord, and H. M. Roder. *Selected Properties of Hydrogen (Engineering Design Data)*. NBS Monograph 168, National Bureau of Standards, Boulder, CO (1981).

¹ NBP = Normal Boiling Point

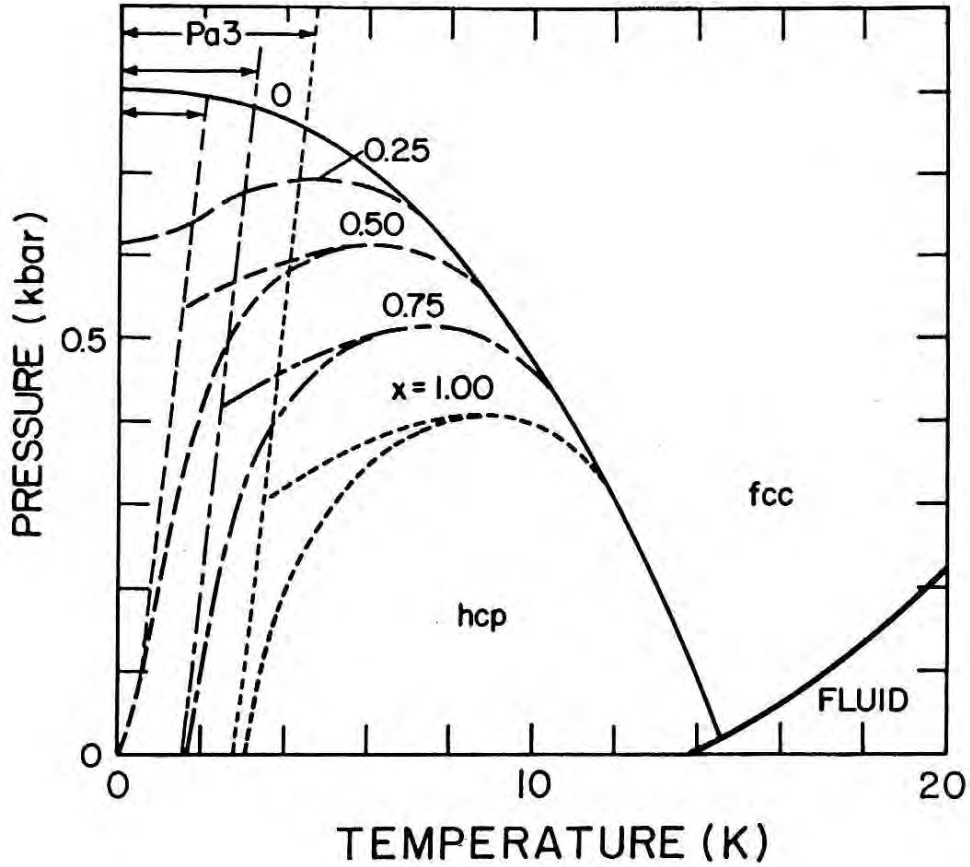

Figure A1.7
Proposed Phase Diagram (P-T Plane) for Solid Hydrogen
at Various Ortho-hydrogen Mole Fractions, x .

Note: Alternate branches are shown for hcp-fcc transition. Heavy solid line is melting curve.
hcp= hexagonal close packed. fcc= face centered cubic.

Source:

McCarty, R. D., J. Hord, and H. M. Roder. *Selected Properties of Hydrogen (Engineering Design Data)*. NBS Monograph 168, National Bureau of Standards, Boulder, CO (1981).

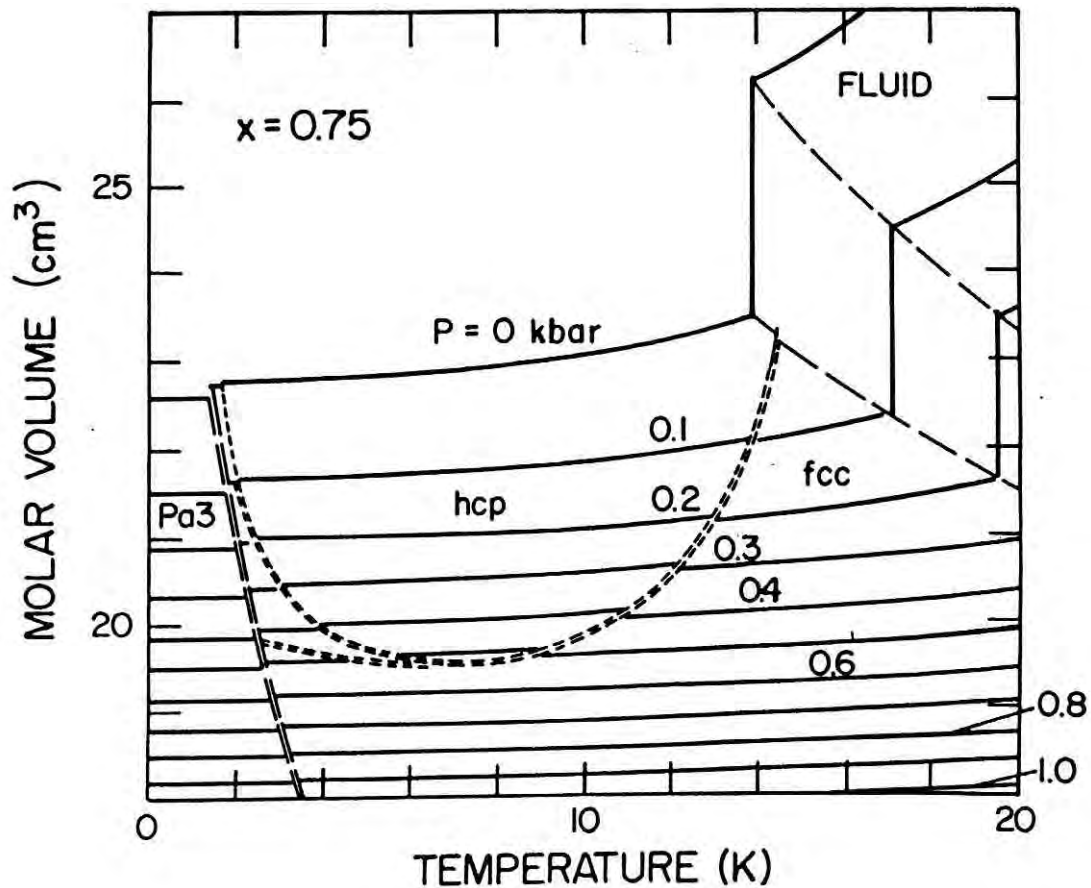

Figure A1.8
Proposed Phase Diagram (V-T Plane) for Solid Normal Hydrogen

Note: Dashed lines indicate alternate branches for hcp-fcc transition curve. x = mole fraction. hcp= hexagonal close packed. fcc= face centered cubic.

Source:

McCarty, R. D., J. Hord, and H. M. Roder. *Selected Properties of Hydrogen (Engineering Design Data)*. NBS Monograph 168, National Bureau of Standards, Boulder, CO (1981).

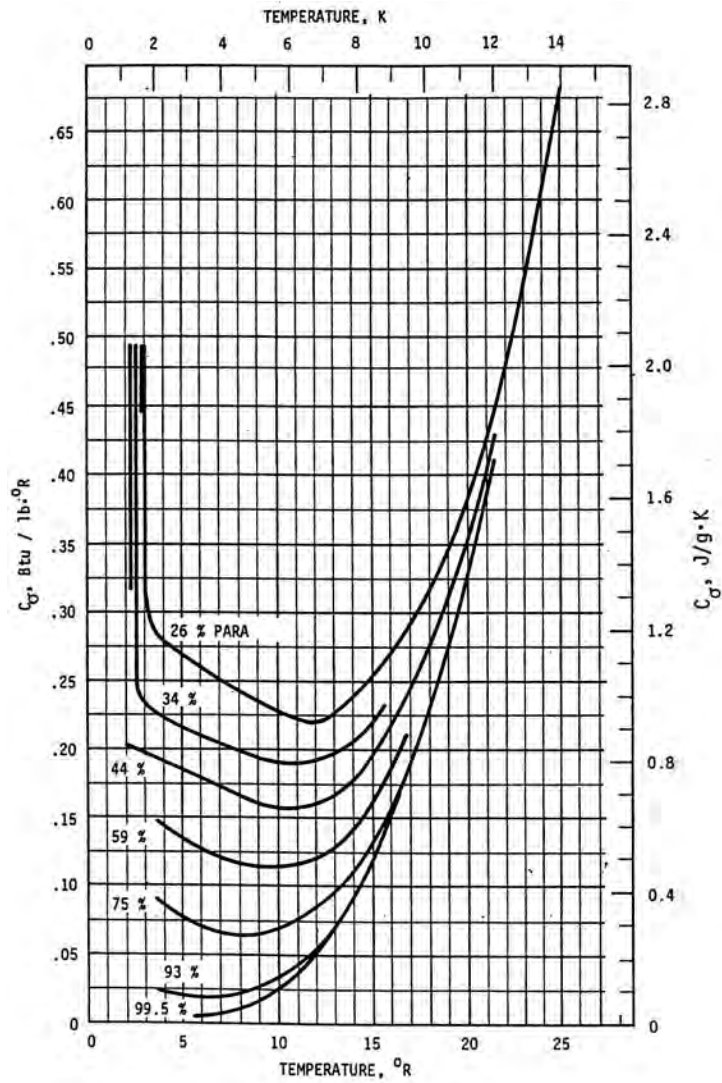

Figure A1.9
Specific Heat (Heat Capacity) of Saturated Solid Hydrogen

Source:

McCarty, R. D., J. Hord, and H. M. Roder. *Selected Properties of Hydrogen (Engineering Design Data)*. NBS Monograph 168, National Bureau of Standards, Boulder, CO (1981).

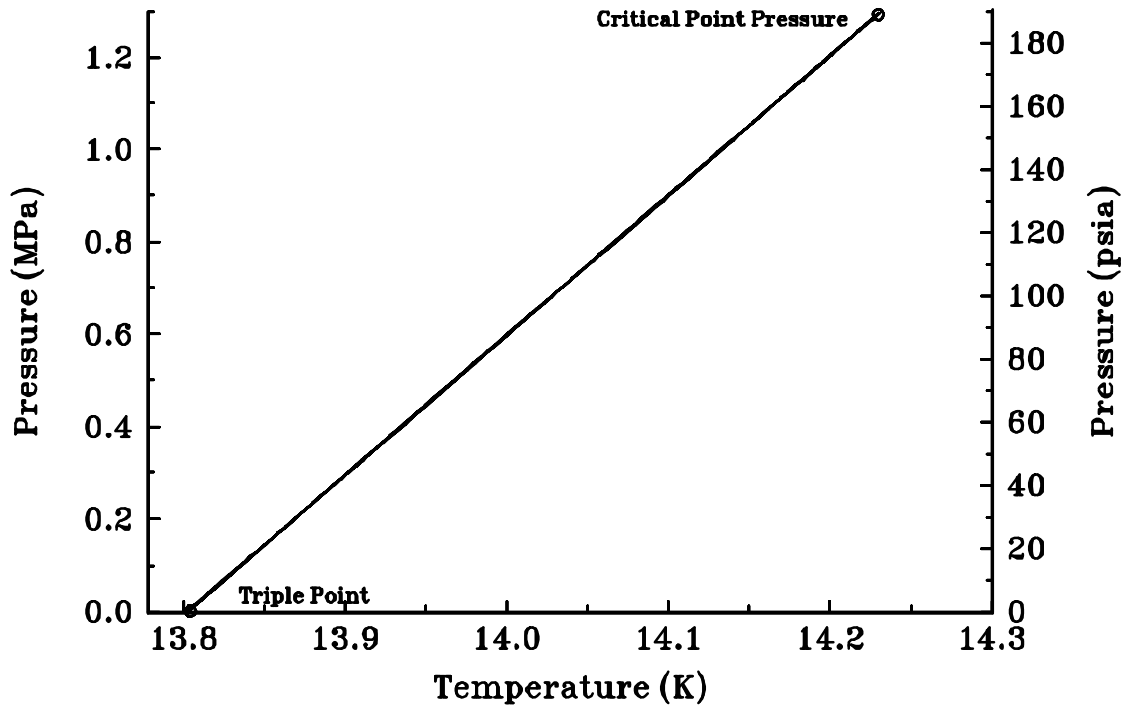

Figure A1.10

Melting Line from Triple Point to Critical Point Pressure for Para-hydrogen

Source:

McCarty, R. D., J. Hord, and H. M. Roder. *Selected Properties of Hydrogen (Engineering Design Data)*. NBS Monograph 168, National Bureau of Standards, Boulder, CO (1981).

Table A1.1
Selected Thermophysical, Chemical, and Combustion Properties of
Gaseous, Liquefied, Slush, and Solid Para-hydrogen^a

Molecular Weight	2.01594	
NORMAL TEMPERATURE AND PRESSURE (NTP) ^b		
Density of GH ₂	83.764 g/m ³	0.00523 lb _m /ft ³
Density of air (for comparison)	1,198 g/m ³	0.0749 lb _m /ft ³
Specific heat at constant pressure, C _p	14.89 kJ/kg·K	3.559 Btu/lb _m ·°R
Specific heat ratio, $\gamma = C_p/C_v$	1.383	
Enthalpy	4097.7 kJ/kg	1762.8 Btu/lb _m
Internal Energy	2888.0 kJ/kg	1242.5 Btu/lb _m
Entropy	64.44 kJ/kg·K	15.40 Btu/lb _m ·°R
Velocity of sound (adiabatic)	1294 m/s	4246 ft/s
Viscosity	8.81 μ Pa·s	0.00881 centipoise
Thermal conductivity, k	19.14 μ W/m·K	0.111 Btu/ft·h·°R
Dielectric constant, ϵ	1.00026	
Compressibility factor, Z	1.0006	
Index of refraction	1.00012	
CRITICAL POINT		
Temperature	32.976 K	-400.6 °F
Pressure	1,292.8 kPa abs	187.5 psia
Density	31.43 kg/m ³	1.96 lb _m /ft ³
Specific heat at saturation, C _{σ}	(very large)	
Specific heat at constant pressure, C _p	(very large)	
Specific heat ratio, $\gamma = C_p/C_v$	(large)	
Enthalpy	38.49 kJ/kg	16.56 Btu/lb _m
Internal Energy	2.83 kJ/kg	1.22 Btu/lb _m
Entropy	17.6 kJ/kg·K	4.20 Btu/lb _m ·°R
Velocity of sound	350 m/s	1148 ft/s
Viscosity	3.5 μ Pa·s	0.0035 centipoise
Thermal conductivity, k	(anomalously large)	
Dielectric constant, ϵ	1.098	
Compressibility factor, Z	0.3025	
NORMAL BOILING POINT (NBP)		
Normal Boiling Temperature (NBT)	20.268 K	-423.2 °F
Pressure	101.3 kPa	14.696 psia
Density		
of vapor	1.338 kg/m ³	0.0835 lb _m /ft ³
of liquid	70.78 kg/m ³	4.42 lb _m /ft ³
Heat of vaporization	445.6 kJ/kg	191.7 Btu/lb _m
Specific heat at saturation, C _{σ}		
of vapor	-16.51 kJ/kg·K	-3.95 Btu/lb _m ·°R
of liquid	9.38 kJ/kg·K	2.24 Btu/lb _m ·°R

Table A1.1 (continued)
 Selected Thermophysical, Chemical, and Combustion Properties of
 Gaseous, Liquefied, Slush, and Solid Para-hydrogen^a

Specific heat at constant pressure, C_p		
of vapor	12.15 kJ/kg·K	2.904 Btu/lb _m ·°R
of liquid	9.688 kJ/kg·K	2.315 Btu/lb _m ·°R
Specific heat ratio, $\gamma = C_p/C_v$		
of vapor	1.869	
of liquid	1.688	
Enthalpy		
of vapor	189.3 kJ/kg	81.5 Btu/lb _m
of liquid	-256.3 kJ/kg	-110.2 Btu/lb _m
Internal energy		
of vapor	113.6 kJ/kg	48.87 Btu/lb _m
of liquid	-257.7 kJ/kg	-110.9 Btu/lb _m
Entropy		
of vapor	29.97 kJ/kg·K	7.162 Btu/lb _m ·°R
of liquid	7.976 kJ/kg·K	1.906 Btu/lb _m ·°R
Velocity of sound (adiabatic)		
of vapor	355 m/s	1165 ft/s
of liquid	1093 m/s	3586 ft/s
Viscosity		
of vapor	1.1 μPa·s	0.0011 centipoise
of liquid	13.2 μPa·s	0.0132 centipoise
Thermal conductivity, k		
of vapor	1.69 μW/m·K	0.00977 Btu/ft·h·°R
of liquid	9.9 μW/m·K	0.0572 Btu/ft·h·°R
Dielectric constant, ϵ		
of vapor	1.0040	
of liquid	1.230	
Compressibility factor, Z		
of vapor	0.9061	
of liquid	0.01712	
Surface tension of liquid	0.00193 N/m	1.1x10 ⁻⁵ lb _f /in
Index of refraction of liquid	1.110	
TRIPLE POINT		
Temperature	13.803 K	-434.8 °F
Pressure	7.04 kPa abs	1.02 psia
Density		
of vapor	0.1258 kg/m ³	0.00784 lb _m /ft ³
of liquid	77.03 kg/m ³	4.81 lb _m /ft ³
of solid	86.50 kg/m ³	5.40 lb _m /ft ³
Heat of fusion	58.29 kJ/kg	25.08 Btu/lb _m
Heat of vaporization	449.17 kJ/kg	193.2 Btu/lb _m
Heat of sublimation	507.39 kJ/kg	218.3 Btu/lb _m

Table A1.1 (continued)
 Selected Thermophysical, Chemical, and Combustion Properties of
 Gaseous, Liquefied, Slush, and Solid Para-hydrogen^a

Specific heat at saturation, C_σ		
of vapor	-23.28 kJ/kg·K	-5.57 Btu/lb _m ·°R
of liquid	6.87 kJ/kg·K	1.64 Btu/lb _m ·°R
of solid	2.84 kJ/kg·K	0.679 Btu/lb _m ·°R
Specific heat at constant pressure, C_p		
of vapor	10.52 kJ/kg·K	2.513 Btu/lb _m ·°R
of liquid	6.513 kJ/kg·K	1.557 Btu/lb _m ·°R
Specific heat ratio, $\gamma = C_p/C_v$		
of vapor	1.693	
of liquid	1.382	
Enthalpy		
of vapor	140.3 kJ/kg	60.4 Btu/lb _m
of liquid	-308.9 kJ/kg	-132.9 Btu/lb _m
of solid	-367.2 kJ/kg	-158.0 Btu/lb _m
Internal energy		
of vapor	84.23 kJ/kg	36.24 Btu/lb _m
of liquid	-309.0 kJ/kg	-132.9 Btu/lb _m
of solid	-367.3 kJ/kg	-158.0 Btu/lb _m
Entropy		
of vapor	37.52 kJ/kg·K	8.967 Btu/lb _m ·°R
of liquid	20.16 kJ/kg·K	1.186 Btu/lb _m ·°R
of solid	0.739 kJ/kg·K	0.177 Btu/lb _m ·°R
Velocity of sound		
of vapor	305 m/s	1001 ft/s
of liquid	1273 m/s	4177 ft/s
Viscosity		
of vapor	0.74 μPa·s	0.00074 centipoise
of liquid	26.0 μPa·s	0.026 centipoise
Thermal conductivity, k		
of vapor	1.24 μW/m·K	0.00717 Btu/ft·h·°R
of liquid	7.3 μW/m·K	0.0422 Btu/ft·h·°R
of solid	90 μW/m·K	0.52 Btu/ft·h·°R
Dielectric constant, ϵ		
of vapor	1.00038	
of liquid	1.252	
of solid	1.286	
Compressibility factor, Z		
of vapor	0.9850	
of liquid	0.001606	
Density of slush (50% by mass solid)	81.50 kg/m ³	5.09 lb _m /ft ³
Density of slush (50% by volume solid)	81.77 kg/m ³	5.11 lb _m /ft ³

Table A1.1 (continued)
Selected Thermophysical, Chemical, and Combustion Properties of
Gaseous, Liquefied, Slush, and Solid Para-hydrogen

Gaseous, Liquefied, Slush, and Solid Para-hydrogen^aTHER PROPERTIES		
Equivalent vol solid @ TP/vol liquid @ NBT	0.8181	
Equivalent vol gas @ NTP/vol liquid @ NBT	845.1	
Pressure required to maintain NBP liquid density in NTP GH ₂ (fixed volume, no venting)	172 MPa	25,000 psi
Joule-Thomson inversion temperature	193 K	-112 °F
Heat of combustion (low)	119.93 kJ/g	51,573 Btu/lb _m
Heat of combustion (high)	141.86 kJ/g	61,003 Btu/lb _m
Limits of flammability in NTP air	4.0 to 75.0 vol %	
Limits of flammability in NTP oxygen	4.1 to 94.0 vol %	
Limits of detonability in NTP air	18.3 to 59.0 vol %	
Limits of detonability in NTP oxygen	15 to 90 vol %	
Stoichiometric composition in air	29.53 vol %	
Minimum energy for ignition in air	0.017 mJ	1.6x10 ⁻⁸ Btu
Autoignition temperature	858 K	1085 °F
Hot air-jet ignition temperature	943 K	1238 °F
Flame temperature in air	2318 K	3713 °F
Thermal energy radiated from flame to surroundings	17 to 25%	
Burning velocity in NTP air	265 to 325 cm/s	104 to 128 in/s
Detonation velocity in NTP air	1.48 to 2.15 km/s	4856 to 7054 ft/s
Diffusion coefficient in NTP air	0.61 cm ² /s	0.095 in ² /s
Diffusion velocity in NTP air	< 2.0 cm/s	0.79 in/s
Buoyant velocity in NTP air	1.2 to 9 m/s	3.9 to 30 ft/s
Maximum experimental safe gap in NTP air	0.008 cm	0.003 in.
Quenching gap in NTP air	0.064 cm	0.025 in.
Detonation induction distance in NTP air	L/D≈100	
Limiting oxygen index	5.0 vol %	
Vaporization rates (steady state) of liquid pools without burning	2.5 to 5.0 cm/s	1 to 2 in/s
Burning rates of spilled liquid pools	0.5 to 1.1 mm/s	0.02 to 0.04 in/s
Energy of explosion (theoretical explosive yield)		
≈24 (g TNT)/(g H ₂)	≈24 (lb _m TNT)/(lb _m H ₂)	
0.17 (g TNT)/(kJ H ₂)	4.0x10 ⁻⁴ (lb _m TNT)/(Btu H ₂)	
2.02 (kg TNT)/m ³ NTP GH ₂)	0.126 lb _m TNT)/(ft ³ NTP GH ₂)	
1.71 (g TNT)/(cm ³ NBP LH ₂)	107.3(lb _m TNT)/(ft ³ NBP LH ₂)	

^a McCarty, R. D., J. Hord, and H. M. Roder, *Selected Properties of Hydrogen (Engineering Design Data)*, NBS Monograph 168, National Bureau of Standards, Boulder, CO (1981).

^b NTP = 293 K (68 °F) and 101.3 kPa (14.69 psia)

NOTE: Temperature dependent ortho-para changes continue to influence properties in the solid state. Several properties (such as specific heat, thermal conductivity, and thermal diffusivity) are highly sensitive to actual ortho-para composition.

Table A1.2
Fixed Point Properties of Normal Hydrogen^b

Properties	Triple Point			Normal Boiling Point		Critical Point	STP	NTP
	Solid	Liquid	Vapor	Liquid	Vapor			
Temperature ^a , °F (K)	-434.55 (13.957)	-434.55 (13.957)	-434.55 (13.957)	-422.97 (20.390)	-422.97 (20.390)	-399.93 (33.190)	32.000 (273.15)	68.000 (293.15)
Pressure (inches Hg) (mm Hg)	2.147 (54.04)	2.147 (54.04)	2.147 (54.04)	30.19 (760.0)	30.19 (760.0)	391.9 (9865)	30.19 (760.0)	30.19 (760.0)
Density, lb/ft ³ (mol/cm ³)	5.409 (0.04301)	4.817 (0.03830)	8.099x10 ⁻³ (0.0644x10 ⁻³)	4.427 (0.0352)	83.05x10 ⁻³ (0.6604x10 ⁻³)	1.879 (0.01494)	5.609x10 ⁻³ (0.0446x10 ⁻³)	5.225x10 ⁻³ (0.04155x10 ⁻³)
Specific volume, ft ³ /lb (cm ³ /mol)	0.1849 (23.25)	0.2076 (26.11)	123.5 (15.530)	0.2259 (28.41)	12.05 (1514)	0.5322 (66.93)	178.3 (22.420)	191.38 (24.070)
Compressibility factor, Z = PV/RT	----	0.001621	0.9635	0.01698	0.9051	0.3191	1.00042	1.00049
Heats of fusion and vaporization, Btu/lb (J/mol)	24.99 (117.1)	194.4 (911.3)	---- ----	191.9 (899.1)	---- ----	0 (0)	---- ----	---- ----
Specific heat, Btu/lb·°R (J/g·K)								
At saturation, C _σ	0.6794 (2.842)	1.642 (6.870)	-5.565 (-23.28)	2.242 (9.380)	-3.946 (-16.51)	very large	---- ----	---- ----
At constant pressure, C _p	---- ----	1.569 (6.563)	2.516 (10.526)	2.336 (9.772)	2.917 (12.20)	very large	3.390 (14.18)	3.425 (14.33)
At constant volume, C _v	----	1.130 (4.727)	1.484 (6.211)	1.375 (5.754)	1.565 (6.548)	2.336 (9.772)	2.407 (10.07)	2.419 (10.12)
Specific heat ratio, γ= C _p /C _v	----	1.388	1.695	1.698	1.863	large	1.408	1.416

Table A1.2 (continued)
Fixed Point Properties of Normal Hydrogen

Properties	Triple Point			Normal Boiling Point		Critical Point	STP	NTP
	Solid	Liquid	Vapor	Liquid	Vapor			
Enthalpy Btu/lb (J/mol)	68.63 (321.6)	93.62 (438.7)	288.1 (1350)	117.0 (548.3)	308.9 (1447)	248.4 (1164)	1654 (7749)	1776 (8324)
Internal energy, Btu/lb (J/mol)	67.84 (317.9)	92.83 (435.0)	263.5 (1235)	116.5 (545.7)	276.2 (1294)	---- ----	1169 (5477)	1256 (5885)
Entropy, Btu/hr·°R (J/mol K)	2.41 (20.3)	3.40 (28.7)	11.1 (93.6)	4.14 (34.92)	9.36 (78.94)	6.47 (54.57)	16.5 (139.6)	16.8 (141.6)
Velocity of sound, ft/s (m/s)	---- ----	4206 (1282)	1007 (307)	3612 (1101)	1171 (357)	---- ----	4088 (1246)	4246 (1294)
Viscosity, centipoise (μPa·s)	---- ----	0.026 (26)	0.00074 (0.74)	0.0132 (13.2)	0.0011 (1.1)	0.0035 (3.5)	0.00839 (8.39)	0.00881 (8.81)
Thermal conductivity, k Btu/ft·h·°R (μW/m·K)	0.52 (90)	0.042 (7.3)	0.0072 (1.24)	0.057 (9.9)	0.0098 (1.69)	anomalously large	0.098 (17.40)	0.106 (18.38)
Prandtl no.	----	2.34	0.630	1.30	0.798	----	0.682	0.688
Dielectric constant, ε	1.287	1.253	1.00039	1.231	1.0040	1.0937	1.000271	1.000253
Index of refraction	1.134	1.119	1.000196	1.1093	1.0020	1.0458	1.000136	1.000126
Surface tension, lbf/in (N/m)	---- ----	0.0171x10 ⁻³ (3.00x10 ⁻³)	---- ----	0.0111x10 ⁻³ (1.94x10 ⁻³)	---- ----	0 (0)	---- ----	---- ----
Equivalent volume per volume of liquid at NBT	0.8184	0.9190	546.3	1.000	53.30	2.357	789.3	847.1

^a These temperatures are based on the IPTS-1968 temperature scale.

^b McCarty, R. D., J. Hord, and H. M. Roder, *Selected Properties of Hydrogen (Engineering Design Data)*, NBS Monograph 168, National Bureau of Standards, Boulder, Colorado, (1981).

NOTE: Dashes indicate not applicable.

Table A1.3
Thermodynamic Properties of the Hydrogen Solid-Vapor Two Phase Region^a

Pressure (ATM)	Temp (K)	V-SOL (CC/MOL)	D-SOL (MOL/L)	H-SOL (J/MOL)	S-SOL (J/MOL-K)	U-SOL (J/MOL)	C-SAT (J/MOL-K)	C-P (J/MOL-K)	ΔHSUB (J/MOL)	V-VAP (CC/MOL)	D-VAP (MOL/L)	H-VAP (J/MOL)	S-VAP (J/MOL-K)	U-VAP (J/MOL)
.06950	13.8	23.30	42.911	-740.2	1.500	-740.4	5.634	5.640	1022.1	16010.	.06238	281.9	75.57	169.0
.06505	13.7	23.29	42.931	-740.8	1.459	-740.9	5.502	5.508	1021.0	17015.	.05877	280.2	75.98	168.1
.06084	13.6	23.28	42.950	-741.3	1.420	-741.5	5.371	5.377	1019.8	18074.	.05533	278.5	76.40	167.0
.05685	13.5	23.27	42.969	-741.8	1.380	-742.0	5.243	5.248	1018.5	19213.	.05205	276.7	76.83	166.0
.05308	13.4	23.26	42.989	-742.4	1.342	-742.5	5.117	5.122	1017.3	20441.	.04892	274.9	77.26	165.0
.04951	13.3	23.25	43.007	-742.9	1.304	-743.0	4.992	4.997	1016.0	21765.	.04594	273.1	77.69	163.9
.04614	13.2	23.24	43.026	-743.4	1.267	-743.5	4.870	4.874	1014.6	23194.	.04311	271.3	78.13	162.9
.04296	13.1	23.23	43.045	-743.8	1.230	-743.9	4.750	4.754	1013.3	24738.	.04042	269.5	78.58	161.8
.03996	13.0	23.22	43.063	-744.3	1.194	-744.4	4.631	4.635	1011.9	26407.	.03787	267.6	79.03	160.7
.03713	12.9	23.21	43.082	-744.8	1.159	-744.8	4.514	4.518	1010.5	28215.	.03544	265.7	79.49	159.6
.03447	12.8	23.20	43.100	-745.2	1.124	-745.3	4.400	4.403	1009.0	30173.	.03314	263.8	79.96	158.4
.03197	12.7	23.19	43.118	-745.6	1.090	-745.7	4.287	4.290	1007.6	32298.	.03096	261.9	80.43	157.3
.02962	12.6	23.18	43.135	-746.1	1.057	-746.1	4.176	4.179	1006.1	34606.	.02890	260.0	80.90	156.2
.02741	12.5	23.17	43.153	-746.5	1.024	-746.5	4.067	4.070	1004.5	37114.	.02694	258.1	81.39	155.0
.02534	12.4	23.16	43.170	-746.9	0.992	-746.9	3.960	3.963	1003.0	39845.	.02510	256.1	81.88	153.8
.02340	12.3	23.15	43.188	-747.3	0.960	-747.3	3.855	3.858	1001.4	42821.	.02335	254.2	82.38	152.6
.02158	12.2	23.15	43.205	-747.6	0.929	-747.7	3.751	3.753	999.8	46067.	.02171	252.2	82.88	151.5
.01988	12.1	23.14	43.222	-748.0	0.899	-748.1	3.650	3.652	998.2	49613.	.02016	250.2	83.40	150.3
.01830	12.0	23.13	43.238	-748.4	0.869	-748.4	3.550	3.552	996.6	53491.	.01869	248.2	83.92	149.0
.01681	11.9	23.12	43.255	-748.7	0.839	-748.8	3.452	3.454	994.9	57738.	.01732	246.2	84.45	147.8
.01543	11.8	23.11	43.271	-749.1	0.811	-749.1	3.356	3.358	993.2	62395.	.01603	244.2	84.98	146.6
.01415	11.7	23.10	43.287	-749.4	0.783	-749.4	3.261	3.263	991.5	67509.	.01481	242.1	85.53	145.4
.01295	11.6	23.09	43.303	-749.7	0.755	-749.8	3.169	3.170	989.8	73131.	.01367	240.1	86.09	144.1
.01184	11.5	23.08	43.319	-750.0	0.728	-750.1	3.078	3.079	988.1	79321.	.01261	238.1	86.65	142.9
.01081	11.4	23.08	43.335	-750.3	0.701	-750.4	2.989	2.990	986.3	86146.	.01161	236.0	87.22	141.6
.00986	11.3	23.07	43.350	-750.6	0.676	-750.7	2.901	2.902	984.6	93682.	.01067	233.9	87.81	140.4
.00898	11.2	23.06	43.366	-750.9	0.650	-750.9	2.815	2.816	982.8	102017.	.00980	231.9	88.40	139.1
.00816	11.1	23.05	43.381	-751.2	0.625	-751.2	2.731	2.732	981.0	111248.	.00899	229.8	89.00	137.8
.00741	11.0	23.04	43.396	-751.5	0.601	-751.5	2.649	2.650	979.2	121489.	.00823	227.7	89.62	136.5
.00671	10.9	23.04	43.411	-751.7	0.577	-751.7	2.568	2.569	977.3	132869.	.00753	225.6	90.24	135.3
.00607	10.8	23.03	43.425	-752.0	0.554	-752.0	2.489	2.490	975.5	145535.	.00687	223.5	90.88	134.0
.00549	10.7	23.02	43.440	-752.2	0.531	-752.2	2.412	2.412	973.6	159656.	.00626	221.4	91.52	132.7
.00495	10.6	23.01	43.454	-752.5	0.509	-752.5	2.336	2.336	971.8	175429.	.00570	219.3	92.18	131.4
.00445	10.5	23.01	43.468	-752.7	0.487	-752.7	2.262	2.262	969.9	193077.	.00518	217.2	92.86	130.1
.00400	10.4	23.00	43.482	-752.9	0.466	-752.9	2.189	2.189	968.0	212861.	.00470	215.1	93.54	128.8
.00359	10.3	22.99	43.496	-753.1	0.445	-753.1	2.118	2.118	966.1	235082.	.00425	213.0	94.24	127.5
.00321	10.2	22.98	43.509	-753.3	0.424	-753.3	2.048	2.048	964.2	260087.	.00384	210.8	94.95	126.2
.00287	10.1	22.98	43.523	-753.5	0.405	-753.5	1.980	1.980	962.2	288284.	.00347	208.7	95.68	124.9
.00256	10.0	22.97	43.536	-753.7	0.385	-753.7	1.914	1.914	960.3	320146.	.00312	206.6	96.42	123.5
(MM HG)	(K)	(CC/MOL)	(CAL/MOL)	(CAL/MOL-K)	(CAL/MOL-K)	(CAL/MOL)	(Z, VAPOR)	(CAL/MOL)	(CAL/MOL-K)					
.1917E+01	10.0	22.873	1.4790000	.1975000	.5751000	230.55	.99878	232.03	23.252					
.5343E+00	9.0	22.809	.9788000	.1450000	.4280000	226.12	.99956	227.10	25.269					
.1118E+00	8.0	22.754	.6139000	.1022000	.3054000	221.53	1.00000	222.15	27.794					
.1561E-01	7.0	22.711	.3598000	.0684200	.2065000	216.82	1.00000	217.18	31.043					
.1198E-02	6.0	22.678	.1933000	.0429100	.1301000	212.02	1.00000	212.21	35.379					
.3570E-04	5.0	22.660	.0927500	.0247300	.0742000	207.15	1.00000	207.24	41.455					
.2080E-06	4.0	22.650	.0379900	.0126600	.0379900	202.24	1.00000	202.28	50.572					
.4832E-10	3.0	22.646	.0120200	.0053420	.0160300	197.30	1.00000	197.31	65.771					
.3985E-17	2.0	22.645	.0023740	.0015830	.0047490	192.34	1.00000	192.34	96.170					
.8255E-38	1.0	22.645	.0001484	.0001979	.0005936	187.37	1.00000	187.37	187.372					

^a McCarty, R. D., J. Hord, and H. M. Roder, *Selected Properties of Hydrogen (Engineering Design Data)*, NBS Monograph 168, National Bureau of Standards, Boulder, CO (1981).

Table A1.4
Thermodynamic Properties of the Hydrogen Solid-Liquid Two Phase Region^a

Pressure (ATM)	Temp (K)	V-SOL (CC/MOL)	D-SOL (MOL/L)	H-SOL (J/MOL)	S-SOL (J/MOL-K)	U-SOL (J/MOL)	ΔHFUS (J/MOL)	V-LIQ (CC/MOL)	D-LIQ (MOL/L)	H-LIQ (J/MOL)	S-LIQ (J/MOL-K)	U-LIQ (J/MOL)
.0695	13.8	23.30	42.911	-740.2	1.500	-740.4	117.3	26.17	38.214	-622.9	10.00	-623.1
5.976	14.0	23.27	42.972	-724.9	1.595	-739.0	118.4	26.07	38.354	-606.6	10.05	-622.4
11.982	14.2	23.23	43.048	-709.5	1.685	-737.7	119.5	25.97	38.502	-590.0	10.10	-621.6
18.087	14.4	23.18	43.137	-693.9	1.771	-736.4	120.6	25.87	38.657	-573.3	10.15	-620.7
24.288	14.6	23.13	43.237	-678.1	1.854	-735.1	121.8	25.76	38.816	-556.4	10.19	-619.8
30.585	14.8	23.07	43.346	-662.2	1.933	-733.7	122.9	25.65	38.980	-539.3	10.24	-618.8
36.976	15.0	23.01	43.462	-646.2	2.008	-732.4	124.1	25.55	39.146	-522.1	10.28	-617.8
43.459	15.2	22.94	43.584	-630.0	2.079	-731.1	125.3	25.44	39.314	-504.7	10.32	-616.8
50.033	15.4	22.88	43.710	-613.8	2.145	-729.7	126.5	25.33	39.483	-487.2	10.36	-615.6
56.69	15.6	22.81	43.840	-597.4	2.208	-728.4	127.7	25.22	39.652	-469.6	10.40	-614.5
63.45	15.8	22.74	43.971	-580.9	2.267	-727.1	129.0	25.11	39.821	-451.9	10.43	-613.3
70.29	16.0	22.67	44.104	-564.3	2.321	-725.8	130.2	25.01	39.989	-434.0	10.46	-612.1
77.22	16.2	22.60	44.238	-547.6	2.372	-724.4	131.5	24.90	40.155	-416.0	10.49	-610.9
84.23	16.4	22.54	44.372	-530.8	2.419	-723.1	132.8	24.80	40.319	-397.9	10.52	-609.6
91.33	16.6	22.47	44.506	-513.9	2.463	-721.8	134.1	24.70	40.482	-379.7	10.54	-608.3
98.51	16.8	22.40	44.639	-496.8	2.504	-720.5	135.5	24.60	40.643	-361.4	10.57	-607.0
105.78	17.0	22.34	44.772	-479.7	2.543	-719.2	136.8	24.51	40.801	-342.9	10.59	-605.6
113.13	17.2	22.27	44.903	-462.5	2.578	-717.8	138.2	24.42	40.957	-324.4	10.61	-604.3
120.56	17.4	22.21	45.034	-445.2	2.612	-716.5	139.5	24.32	41.111	-305.7	10.63	-602.8
128.07	17.6	22.14	45.163	-427.8	2.644	-715.1	140.9	24.23	41.263	-286.9	10.65	-601.4
135.66	17.8	22.08	45.292	-410.3	2.673	-713.8	142.3	24.15	41.412	-268.0	10.67	-599.9
143.33	18.0	22.02	45.419	-392.6	2.702	-712.4	143.7	24.06	41.559	-248.9	10.69	-598.4
151.07	18.2	21.96	45.545	-374.9	2.728	-711.0	145.2	23.98	41.704	-229.7	10.70	-596.8
158.90	18.4	21.90	45.670	-357.0	2.753	-709.6	146.6	23.90	41.847	-210.4	10.72	-595.2
166.80	18.6	21.84	45.793	-339.1	2.777	-708.2	148.1	23.82	41.988	-191.0	10.74	-593.5
174.78	18.8	21.78	45.916	-321.0	2.801	-706.7	149.6	23.74	42.127	-171.4	10.76	-591.8
182.83	19.0	21.72	46.037	-302.8	2.824	-705.2	151.0	23.66	42.264	-151.8	10.77	-590.1
190.96	19.2	21.66	46.158	-284.5	2.847	-703.7	152.5	23.59	42.400	-132.0	10.79	-588.3
199.17	19.4	21.61	46.277	-266.1	2.870	-702.2	154.1	23.51	42.533	-112.0	10.81	-586.5
207.44	19.6	21.55	46.396	-247.5	2.892	-700.6	155.6	23.44	42.666	-91.9	10.83	-584.6
215.79	19.8	21.50	46.514	-228.9	2.914	-699.0	157.1	23.37	42.796	-71.8	10.85	-582.7
224.22	20.0	21.45	46.631	-210.1	2.936	-697.3	158.7	23.30	42.925	-51.4	10.87	-580.7
232.71	20.2	21.39	46.747	-191.2	2.956	-695.7	160.3	23.23	43.053	-31.0	10.89	-578.7
241.28	20.4	21.34	46.863	-172.3	2.976	-694.0	161.8	23.16	43.180	-10.4	10.91	-576.6
249.92	20.6	21.29	46.978	-153.2	2.999	-692.2	163.4	23.09	43.305	10.3	10.93	-574.5
258.63	20.8	21.24	47.092	-133.9	3.020	-690.4	165.0	23.03	43.430	31.1	10.95	-572.3
267.41	21.0	21.18	47.206	-114.6	3.041	-688.6	166.7	22.96	43.553	52.0	10.98	-570.1
276.26	21.2	21.13	47.319	-95.2	3.063	-686.8	168.3	22.90	43.675	73.1	11.00	-567.8
285.19	21.4	21.08	47.432	-75.6	3.084	-684.9	169.9	22.83	43.796	94.3	11.03	-565.5
294.18	21.6	21.03	47.544	-56.0	3.106	-682.9	171.6	22.77	43.916	115.6	11.05	-563.1
303.23	21.8	20.98	47.656	-36.2	3.128	-681.0	173.3	22.71	44.036	137.1	11.08	-560.7
312.36	22.0	20.93	47.768	-16.3	3.150	-678.9	175.0	22.65	44.154	158.6	11.10	-558.2
321.56	22.2	20.89	47.879	3.6	3.173	-676.9	176.7	22.59	44.272	180.3	11.13	-555.7
330.82	22.4	20.84	47.990	23.7	3.195	-674.8	178.4	22.53	44.389	202.1	11.16	-553.1
340.15	22.6	20.79	48.101	43.9	3.218	-672.6	180.1	22.47	44.505	224.0	11.19	-550.4

^a McCarty, R. D., J. Hord, and H. M. Roder, *Selected Properties of Hydrogen (Engineering Design Data)*, NBS Monograph 168, National Bureau of Standards, Boulder, CO (1981).

Table A1.5
Molar Volume^a of Compressed Solid Para-hydrogen^b

Pressure (atm)	Temperature (K)				
	11.49	13.98	16.89	18.20	19.97
0	23.08				
25	22.63	22.83			
50	22.22	22.58			
75	21.85	22.24			
100	21.53	21.93			
150		21.26	22.00		
200			21.55	21.52	
250			21.10	21.07	21.45
300				20.70	21.30
350					21.15

^a All values of the molar volume are in cubic centimeters per mole.

^b McCarty, R. D., J. Hord, and H. M. Roder. *Selected Properties of Hydrogen (Engineering Design Data)*. NBS Monograph 168, National Bureau of Standards, Boulder, CO (1981).

Table A1.6
Thermal Expansion of Solid Para-hydrogen^a

Temperature (K)	Thermal Expansion coefficient, $\alpha \times 10^4$ (1/K)	Temperature (K)	Thermal Expansion coefficient, $\alpha \times 10^4$ (1/K)
1	0.022	8	21.7
2	0.22	9	26.7
3	1.0	10	30.4
4	3.0	11	34.6
5	6.5	12	39.4
6	11.3	13	44.7
7	16.5	13.80	49.4

^a McCarty, R. D., J. Hord, and H. M. Roder. *Selected Properties of Hydrogen (Engineering Design Data)*. NBS Monograph 168, National Bureau of Standards, Boulder, CO (1981).

ADDENDUM: SAMPLE MATERIAL SAFETY DATA SHEETS
FOR GASEOUS AND LIQUEFIED HYDROGEN

HYDROGEN - HYDROGEN, TECHNICAL
MATERIAL SAFETY DATA SHEET

FSC: 6830

NIIN: (to be supplied by manufacturer)

Manufacturer's CAGE: (to be supplied by manufacturer)

Part No. Indicator: A

Part Number/Trade Name: HYDROGEN

=====

General Information

=====

Item Name: HYDROGEN, TECHNICAL

Company's Name: (to be supplied by manufacturer)

Company's Street: (to be supplied by manufacturer)

Company's City: (to be supplied by manufacturer)

Company's State: (to be supplied by manufacturer)

Company's Country: (to be supplied by manufacturer)

Company's Zip Code: (to be supplied by manufacturer)

Company's Emer Ph #: (to be supplied by manufacturer)

Company's Info Ph #: (to be supplied by manufacturer)

Record No. For Safety Entry: 001

Tot Safety Entries This Stk#: 003

Status: SM

Date MSDS Prepared: (to be supplied by manufacturer)

Safety Data Review Date: (to be supplied by manufacturer)

Supply Item Manager: (to be supplied by manufacturer)

MSDS Serial Number: (to be supplied by manufacturer)

Specification Number: (to be supplied by manufacturer)

Spec Type, Grade, Class: TYPE I

Hazard Characteristic Code: G2

Unit Of Issue: CF

Unit Of Issue Container Qty: (to be supplied by manufacturer)

Type Of Container: CYLINDER

Net Unit Weight: UNKNOWN

NRC/State License Number: NONE

Net Propellant Weight-Ammo: NONE

=====

Ingredients/Identity Information

=====

Proprietary: NO

Ingredient: HYDROGEN

Ingredient Sequence Number: 01

Percent: 100

NIOSH (RTECS) Number: MW8900000

CAS Number: 1333-74-0

OSHA PEL: NOT ESTABLISHED

ACGIH TLV: NOT ESTABLISHED

Other Recommended Limit: NONE RECOMMENDED

=====
Physical/Chemical Characteristics
=====

Appearance And Odor: COLORLES GAS AT NORMAL TEMPERATURE AND PRESSURE;
ODORLESS

Boiling Point: -422F,-252C

Melting Point: -434F,-259C

Vapor Pressure (MM Hg/70 F): GAS

Vapor Density (Air= 1): 0.696

Specific Gravity: GAS

Decomposition Temperature: UNKNOWN

Evaporation Rate And Ref: N/A

Solubility In Water: NEGLIGIBLE

Viscosity: UNKNOWN

Corrosion Rate (IPY): UNKNOWN

Autoignition Temperature: 968F
=====

Fire and Explosion Hazard Data
=====

Flash Point: FLAMMABLE GAS

Lower Explosive Limit: 4

Upper Explosive Limit: 75

Extinguishing Media: CO2, DRY CHEMICALS, WATER SPRAY OR FOG

Special Fire Fighting Proc: EVACUATE AREA. COOL CONTAINER W/WATER SPRAY
(MAX DISTANCE). DO NOT EXTINGUISH FLAMES, ALLOW TO BURN OUT! USE SCBA.
STOP GAS FLOW & REMOVE CONTAINERS IF W/O RISK

Unusual Fire And Expl Hazrds: FLAME NEARLY INVISIBLE. FORMS EXPOLSIIVE
MIXTURES W/AIR & OXIDIZERS. KEEP CONTAINERS BELOW 125F. ESCAPING GAS MAY
IGNITE SPONTANEOUSLY, HAS LOW IGNITION ENERGY.
=====

Reactivity Data
=====

Stability: YES

Cond To Avoid (Stability): FOLLOW COMPRESSED GAS ASSN INSTRUCTIONS IN
PAMPHLET "SAFE HANDLING OF COMPRESSED GAS IN CONTAINERS".

Materials To Avoid: OXIDIZING AGENTS, LITHIUM, HALOGENS

Hazardous Decomp Products: NONE

Hazardous Poly Occur: NO

Conditions To Avoid (Poly): WILL NOT OCCUR.
=====

Health Hazard Data
=====

LD50-LC50 Mixture: LD50 (ORAL RAT) IS UNKNOWN

Route Of Entry - Inhalation: YES

Route Of Entry - Skin: NO

Route Of Entry - Ingestion: NO

Health Haz Acute And Chronic: INGESTED:UNLIKELY ROUTE OF EXPOSURE. SKIN:NO
EVIDENCE OF ADVERSE EFFECTS. INHALED:SIMPLE ASPHYXIANT. MODERATE
CONCENTRATIONS. MAY CAUSE HEADACHE, DROWSINESS, EXCITATION, EXCESS

SALIVATION, VOMITING & UNCONSCIOUSNESS. EYE:NO EVIDENCE OF ADVERSE EFFECTS.

Carcinogenicity - NTP: NO

Carcinogenicity - IARC: NO

Carcinogenicity - OSHA: NO

Explanation Carcinogenicity: MFR LISTED NO INFORMATION ABOUT THE CARCINOGENICITY OF THIS MATERIAL. HMIS DOES NOT EXPECT IT TO BE CARCINOGENIC.

Signs/Symptoms Of Overexp: INGESTED:UNLIKELY ROUTE OF EXPOSURE. SKIN:NO EVIDENCE OF ADVERSE EFFECTS. INHALED:SIMPLE ASPHYXIANT. HEADACHE, NO EVIDENCE OF ADVERSE EFFECTS.

Med Cond Aggravated By Exp: A KNOWLEDGE OF THE AVAILABLE TOXICOLOGY INFORMATION AND OF THE PHYSICAL & CHEMICAL PROPERTIES OF THE MATERIAL SUGGEST THAT OVEREXPOSURE IS UNLIKELY TO AGGRAVATE EXISTING MEDICAL CONDITIONS.

Emergency/First Aid Proc: INGESTED:PRODUCT IS A GAS AT NORMAL TEMPERATURE & PRESSURE. SKIN:WASH WITH SOAP & WATER. INHALED:REMOVE TO FRESH AIR. GIVE OXYGEN IF BREATHING IS DIFFICULT, ARTIFICIAL RESPIRATION IF NOT BREATHING. GET IMMEDIATE MEDICAL ATTENTION. EYE:FLUSH W/WATER. NOTE TO PHYSICIAN:THERE IS NO SPECIFIC ANTIDOTE. PRODUCT IS RELATIVELY INERT. TREATMENT SHOULD CONTROL SYMPTOMS AND CLINICAL CONDITION.

=====

Precautions for Safe Handling and Use

=====

Steps If Matl Released/Spill: DANGER! FORMS EXPLOSIVE MIXTURES W/AIR! EVACUATE AREA. USE SCBA. REMOVE SOURCES OF IGNITION IF W/O RISK. STOP LEAK IF W/O RISK. VENTILATE AREA OR MOVE CONTAINER TO WELL-VENTILATED AREA IF W/O RISK. CHECK ATMOSPHERE FOR EXPLOSIVENESS BEFORE ENTERING.

Neutralizing Agent: NO INFORMATION GIVEN BY MFR ON MSDS.

Waste Disposal Method: PREVENT WASTE FROM CONTAMINATING SURROUNDING ENVIRONMENT. DISCARD ANY PRODUCT, RESIDUE, DISPOSABLE CONTAINER OR LINER IN AN ENVIRONMENTALLY ACCEPTABLE MANNER IN FULL COMPLIANCE FEDERAL, STATE & LOCAL REGULATIONS.

Precautions-Handling/Storing: FOLLOW COMPRESSED GAS ASSN INSTRUCTIONS IN PAMPHLET "SAFE HANDLING OF COMPRESSED GAS IN CONTAINERS". NEVER WORK ON A PRESSURIZED SYSTEM.

Other Precautions: PROTECT CYLINDERS FROM DIRECT SUNLIGHT & STORE IN A WELL VENTILATED AREA. PROTECT FROM PHYSICAL DAMAGE. ISOLATE CYLINDERS FROM OXYGEN & CHLORINE. DO NOT LOAD WITH EXPLOSIVES, POISONS, RADIOACTIVE MATERIALS & ORGANIC PEROXIDES.

=====

Control Measures

=====

Respiratory Protection: NONE REQUIRED UNDER NORMAL USE. HOWEVER AIR SUPPLIED RESPIRATORS ARE REQUIRED WHILE WORKING IN CONFINED SPACES WITH THIS PRODUCT. THE RESPIRATORY PROTECTION USE MUST CONFORM WITH OSHA RULES IN 29 CFR1910.134.

Ventilation: USE EXPLOSION PROOF GENERAL/LOCAL EXHAUST SUFFICIENT TO CONTROL WORKER EXPOSURE.

Protective Gloves: PREFERRED FOR CYLINDER HANDLING

Eye Protection: SELECT PER OSHA 29CFR1910.133
Other Protective Equipment: METATARSAL SHOES FOR CYLINDER HANDLING. SELECT PER OSHA 29CFR1910.132 & 1910.133.
Work Hygienic Practices: MFR: ? HMIS:USE GOOD INDUSTRIAL HYGIENE PRACTICE. AVOID UNNECESSARY EXPOSURE. WASH THOROUGHLY BEFORE EATING OR DRINKING
Suppl. Safety & Health Data: NONE

=====
Transportation Data
=====

Trans Data Review Date: 94365
DOT PSN Code: HLR
DOT Proper Shipping Name: HYDROGEN, COMPRESSED
DOT Class: 2.1
DOT ID Number: UN1049
DOT Label: FLAMMABLE GAS
IMO PSN Code: IGH
IMO Proper Shipping Name: HYDROGEN, COMPRESSED
IMO Regulations Page Number: 2148
IMO UN Number: 1049
IMO UN Class: 2(2.1)
IMO Subsidiary Risk Label: -
IATA PSN Code: NSD
IATA UN ID Number: 1049
IATA Proper Shipping Name: HYDROGEN, COMPRESSED
IATA UN Class: 2.1
IATA Label: FLAMMABLE GAS
AFI PSN Code: NSD
AFI Symbols: 0
AFI Prop. Shipping Name: HYDROGEN, COMPRESSED
AFI Class: 2.1
AFI ID Number: UN1049
AFI Label: FLAMMABLE GAS
AFI Basic Pac Ref: 6-6,6-10

=====
Disposal Data
=====

=====
Label Data
=====

Label Required: YES
Technical Review Date: 31DEC94
MFR Label Number: NONE
Label Status: F
Common Name: HYDROGEN
Signal Word: DANGER!
Acute Health Hazard-Slight: X
Contact Hazard-Slight: X
Fire Hazard-Severe: X

Reactivity Hazard-None: X

Special Hazard Precautions: **TARGET ORGANS:RESPIRATORY SYSTEM**

INGESTED:UNLIKELY ROUTE OF EXPOSURE. SKIN:NO EVIDENCE OF ADVERSE EFFECTS.

INHALED:SIMPLE ASPHYXIANT. MODERATE CONCENTRATIONS MAY CAUSE HEADACHE, DROWSINESS,EXCITATION,EXCESS SALVATION,VOMITING & UNCONSCIOUSNESS.

EYE:NO EVIDENCE OF ADVERSE EFFECTS.

FOLLOW COMPRESSED GAS ASSN INSTRUCTIONS IN DANGER! FORMS EXPLOSIVE MIXTURES W/AIR! EVACUATE AREA,USE SCBA. REMOVE SOURCES OF IGNITION & STOP LEAK IF W/O RISK. VENTILATE AREA OR MOVE CONTAINER TO WELL VENTILATED AREA IF W/O RISK. CHECK ATMOSPHERE FOR EXPLOSIVENESS ENTERING AREA.

Protect Eye: Y

Protect Skin: Y

Label Name: (to be supplied by manufacturer)

Label Street: (to be supplied by manufacturer)

Label City: (to be supplied by manufacturer)

Label State: (to be supplied by manufacturer)

Label Zip Code: (to be supplied by manufacturer)

Label Country: (to be supplied by manufacturer)

Label Emergency Number: (to be supplied by manufacturer)

=====

LIQUID HYDROGEN - CRYOGENIC LIQUID
MATERIAL SAFETY DATA SHEET

FSC: 9135

NIIN: (to be supplied by manufacturer)

Manufacturer's CAGE: (to be supplied by manufacturer)

Part No. Indicator: A

Part Number/Trade Name: LIQUID HYDROGEN

=====

General Information

=====

Item Name: CRYOGENIC LIQUID

Company's Name: (to be supplied by manufacturer)

Company's Street: (to be supplied by manufacturer)

Company's City: (to be supplied by manufacturer)

Company's State: (to be supplied by manufacturer)

Company's Country: (to be supplied by manufacturer)

Company's Zip Code: (to be supplied by manufacturer)

Company's Emerg Ph #: (to be supplied by manufacturer)

Company's Info Ph #: (to be supplied by manufacturer)

Record No. For Safety Entry: 001

Tot Safety Entries This Stk#: 002

Status: SE

Date MSDS Prepared: (to be supplied by manufacturer)

Safety Data Review Date: (to be supplied by manufacturer)

Preparer's Company: (to be supplied by manufacturer)

Preparer's St Or P. O. Box: (to be supplied by manufacturer)

Preparer's City: (to be supplied by manufacturer)

Preparer's State: (to be supplied by manufacturer)

Preparer's Zip Code: (to be supplied by manufacturer)

MSDS Serial Number: (to be supplied by manufacturer)

=====

Ingredients/Identity Information

=====

Proprietary: NO

Ingredient: HYDROGEN

Ingredient Sequence Number: 01

Percent: 100

NIOSH (RTECS) Number: MW8900000

CAS Number: 1333-74-0

ACGIH TLV: SIMPLE ASPHYXIANT

=====

Physical/Chemical Characteristics

=====

Appearance And Odor: COLORLESS, ODORLESS CRYOGENIC LIQUID.

Boiling Point: -422.99F

Melting Point: -434.6F

Vapor Density (Air= 1): 0.0696

Specific Gravity: 0.07

Evaporation Rate And Ref: (BU AC = 1): > 3

Solubility In Water: NEGLIGIBLE

Percent Volatiles By Volume: 100

Autoignition Temperature: 968F

=====
Fire and Explosion Hazard Data
=====

Flash Point: FLAMMABLE GAS

Lower Explosive Limit: 4

Upper Explosive Limit: 75

Extinguishing Media: CO2, DRY CHEMICAL, WATER SPRAY/FOG.

Special Fire Fighting Proc: EVACUATE AREA. IMMEDIATELY COOL CONTAINERS W/WATER SPRAY FROM MAXIMUM DISTANCE W/O EXTINGUISHING FLAMES. REMOVE ALL IGNITION SOURCES SAFELY. WEAR SCBA WHERE NEEDED.

SAFELY STOP LEAK WHILE COOLING W/WATER SPRAY. SAFELY REMOVE ALL CONTAINERS FROM AREA. ALLOW FIRE TO BURN OUT.

Unusual Fire And Expl Hazrds: MAY FORM EXPLOSIVE MIXTURES W/AIR & OXIDIZING AGENTS. LIQUID WILL SOLIDIFY AIR & CREATE EXPLOSION HAZARD. CONTAINER MAY RUPTURE DUE TO HEAT OF FIRE. FLAME ALMOST INVISIBLE. FIREBALL IS FORMED IF GAS CLOUD IS IGNITED. EXPLOSIVE ATMOSPHERES MAY LINGER.

=====
Reactivity Data
=====

Stability: YES

Cond To Avoid (Stability): HEAT, FIRE & OTHER IGNITION SOURCES.

Materials To Avoid: OXYGEN, OXIDIZING AGENTS, AIR, LITHIUM, HALOGENS.

Hazardous Decomp Products: NONE

Hazardous Poly Occur: NO

=====
Health Hazard Data
=====

Route Of Entry - Inhalation: YES

Route Of Entry - Skin: NO

Route Of Entry - Ingestion: YES

Health Haz Acute And Chronic: INGESTION: CONTACT W/LIQUID MAY CAUSE FROSTBITE OF LIPS & MOUTH. EYES/SKIN: LIQUID CONTACT MAY CAUSE FROSTBITE. INHALATION: ASPHYXIANT. CAN CAUSE RAPID SUFFOCATION/DEATH DUE TO OXYGEN DEFICIENCY.

Carcinogenicity - NTP: NO

Carcinogenicity - IARC: NO

Carcinogenicity - OSHA: NO

Explanation Carcinogenicity: NONE

Signs/Symptoms Of Overexp: HEADACHE, DROWSINESS, DIZZINESS, EXCITATION, EXCESS SALIVATION, VOMITING, UNCONSCIOUSNESS.

Emergency/First Aid Proc: SKIN: IMMEDIATELY WARM FROSTBITE AREA W/WARM WATER. DON'T EXCEED 105F. INHALATION: REMOVE TO FRESH AIR. GIVE CPR/OXYGEN IF NEEDED.

EYES: IMMEDIATELY FLUSH W/WATER FOR 15 MIN.

OBTAIN MEDICAL ATTENTION IN ALL CASES. NOTE TO PHYSICIAN: NO SPECIFIC ANTIDOTE. PRODUCT IS RELATIVELY INERT. TREATMENT OF OVEREXPOSURE SHOULD BE DIRECTED AT CONTROL OF SYMPTOMS & CLINICAL CONDITION.

=====
Precautions for Safe Handling and Use
=====

Steps If Matl Released/Spill: IMMEDIATELY EVACUATE AREA. WEAR SCBA WHERE NEEDED. REMOVE IGNITION SOURCES. REDUCE VAPORS W/FOG/FINE WATER SPRAY. BEFORE ENTERING AREA, CHECK ATMOSPHERE W/APPROPRIATE DEVICE. VENTILATE AREA/MOVE LEAKING CONTAINER TO WELL VENTILATED AREA SAFELY.

Waste Disposal Method: PREVENT WASTE FROM CONTAMINATING SURROUNDING ENVIRONMENT. DISCARD ANY PRODUCT/RESIDUE/DISPOSABLE CONTAINER/LINER IN AN ENVIRONMENTALLY ACCEPTABLE MANNER IAW/FEDERAL, STATE & LOCAL REGULATIONS.

SAFELY SHUT OFF LEAK.

Precautions-Handling/Storing: STORE & USE W/ADEQUATE VENTILATION AT ALL TIMES. USE ONLY IN CLOSED SYSTEM. CLOSE VALVE WHEN NOT IN USE/WHEN EMPTY.

KEEP AWAY FROM OXIDIZING AGENTS.

Other Precautions: DON'T GET LIQUID IN EYES, ON SKIN/CLOTHING. USE PIPING & EQUIPMENT DESIGNED TO WITHSTAND PRESSURES/TEMPS TO BE ENCOUNTERED. ONLY USE SPARK/EXPLOSION PROOF EQUIPMENT. GROUND ALL EQUIPMENT. NEVER WORK ON A PRESSURIZED SYSTEM.

=====
Control Measures
=====

Respiratory Protection: NONE REQUIRED UNDER NORMAL USE. WEAR AIR SUPPLIED RESPIRATOR WHILE WORKING IN CONFINED AREAS W/THIS PRODUCT.

Ventilation: EXPLOSION PROOF LOCAL EXHAUST SYSTEM W/SUFFICIENT AIR FLOW VELOCITY RECOMMENDED. GENERAL EXHAUST MAY BE ACCEPTABLE.

Protective Gloves: LOOSE FITTING CRYOGENIC

Eye Protection: SAFETY GLASSES & FULL FACE SHIELD

Other Protective Equipment: METATARSAL SHOES FOR CYLINDER HANDLING, CUFFLESS TROUSERS OUTSIDE SHOES, HIGH TOP SHOES ARE PREFERRED.

Work Hygienic Practices: REMOVE/LAUNDER CONTAMINATED CLOTHING BEFORE REUSE.

Suppl. Safety & Health Data: NONE

=====
Transportation Data
=====

=====
Disposal Data
=====

=====
Label Data
=====

Label Required: YES

Label Status: G

Common Name: LIQUID HYDROGEN

Special Hazard Precautions: INGESTION: CONTACT W/LIQUID MAY CAUSE FROSTBITE OF LIPS & MOUTH. EYES/SKIN: LIQUID CONTACT MAY CAUSE FROSTBITE. INHALATION: ASPHYXIANT. CAN CAUSE RAPID SUFFOCATION/DEATH DUE TO OXYGEN DEFICIENCY. HEADACHE, DROWSINESS, DIZZINESS, EXCITATION, EXCESS SALIVATION, VOMITING, UNCONSCIOUSNESS.

Label Name: (to be supplied by manufacturer)

Label Street: (to be supplied by manufacturer)

Label City: (to be supplied by manufacturer)

Label State: (to be supplied by manufacturer)

Label Zip Code: (to be supplied by manufacturer)

Label Country: (to be supplied by manufacturer)

Label Emergency Number: (to be supplied by manufacturer)
=====

A.2 FLAMMABILITY, FIRES, DEFLAGRATION, AND DETONATION

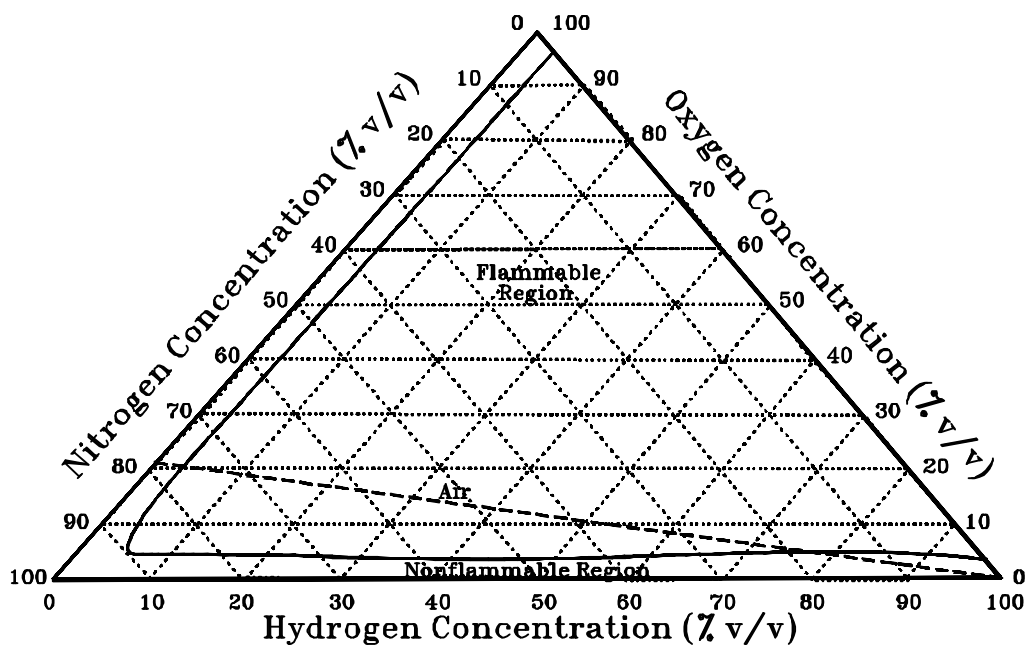

Figure A2.1
 Flammability Limits at a Pressure of 101.3 kPa (14.7 psia)
 and a Temperature of 298 K (77 °F)

Sources:

Coward, H. F. and G. W. Jones. *Limits of Flammability of Gases and Vapors*. Bureau of Mines Bulletin 503, N70-74476; AD-701575 (1952).

Payman, W. and H. Titman. "Limits of Inflammability of Hydrogen and Deuterium in Oxygen and Air." *Nature*, 137 (1936): pp. 160-168.

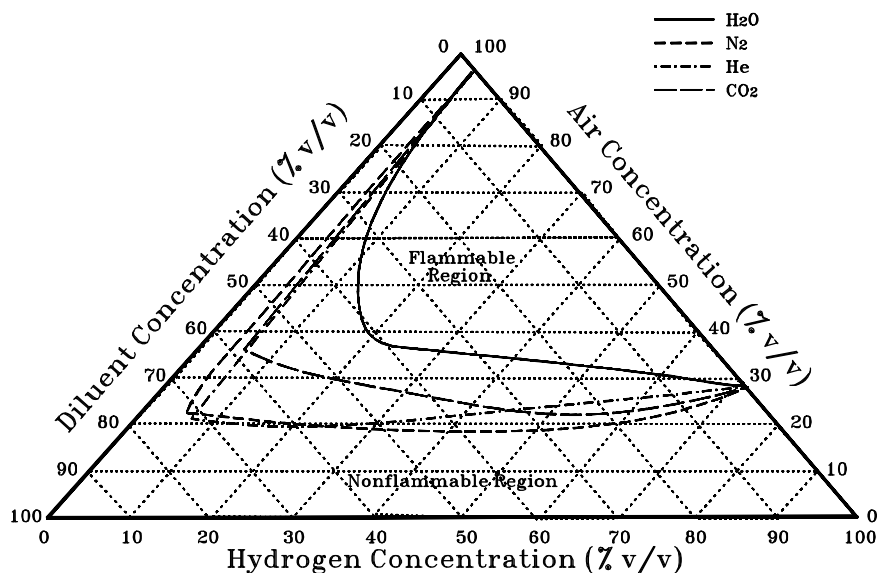

Figure A2.2

Effects of N₂, He, CO₂, and H₂O Diluents on Flammability Limits of Hydrogen in Air at 101.3 kPa (14.7 psia) (The effects of N₂, He, and CO₂ are at 298 K (77 °F) and H₂O is at 422 K (300 °F))

Sources:

N₂, He, CO₂: Coward, H. F. and G. W. Jones. *Limits of Flammability of Gases and Vapors*. Bureau of Mines Bulletin 503, 1952, N70-74476; AD-701575.

CO₂: Jones, G. W. and G. St. J. Perrott. "Oxygen Required for the Propagation of Hydrogen, Carbon Monoxide, and Methane Flames". *Ind. Eng. Chem.*, 19 (9), (1927): pp. 985-989.

H₂O: Coley, G. D. and J. E. Field. "Role of Cavities in the Initiation and Growth of Explosions in Liquids." *Proceedings of the Royal Society of London Series A*, 335 (1600), (1973): pp. 67-86.

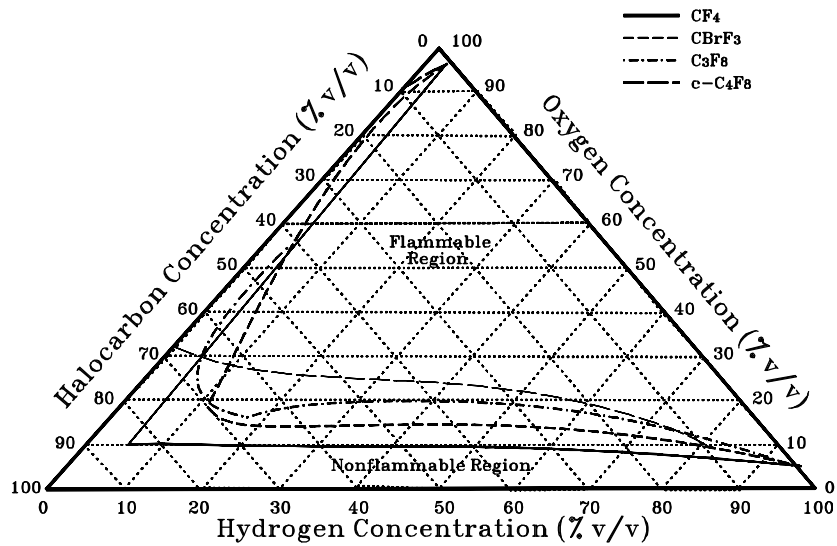

Figure A2.3

Effects of Halocarbon Inhibitors on Flammability Limits of Hydrogen-Oxygen Mixtures at a Pressure of 101.3 kPa (14.7 psia) and a Temperature of 298 K (77 °F)

Source:

McHale, E. T., R. W. Geary, G. von Elbe, and C. Huggett, "Flammability Limits of $\text{GH}_2\text{-GO}_2\text{-gFluorocarbon}$ Mixtures," *Combustion and Flame*, (1971): 16 (2): pp. 167-175.

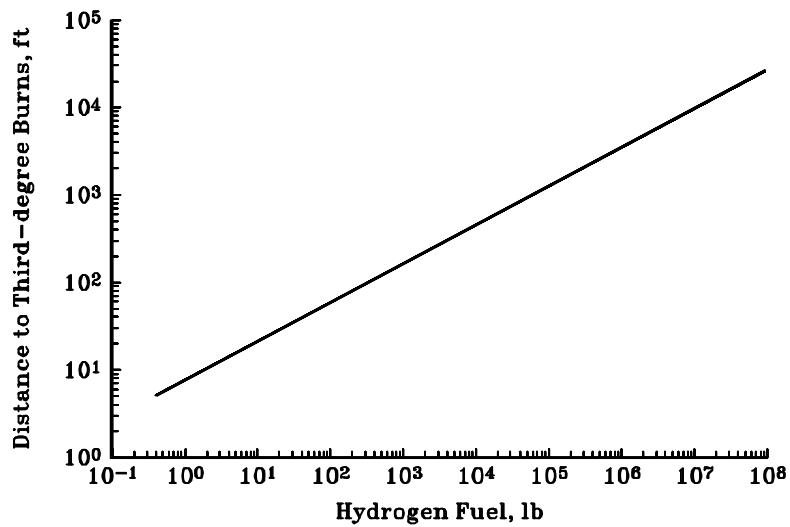

Figure A2.4

Distance for Fireball Radiation Flux Induced Third Degree Burns per Amount of Fuel Burned at a Thermal Radiation Intensity of 134 kJ/m² (11.8 Btu/ft²)

Source:

Siegel, R. and J. R. Howell. *Thermal Radiation Heat Transfer. Vol 3: Radiation Transfer with Absorbing, Emitting, and Scattering Media.* NASA SP-164: Vol. 3 (1971).

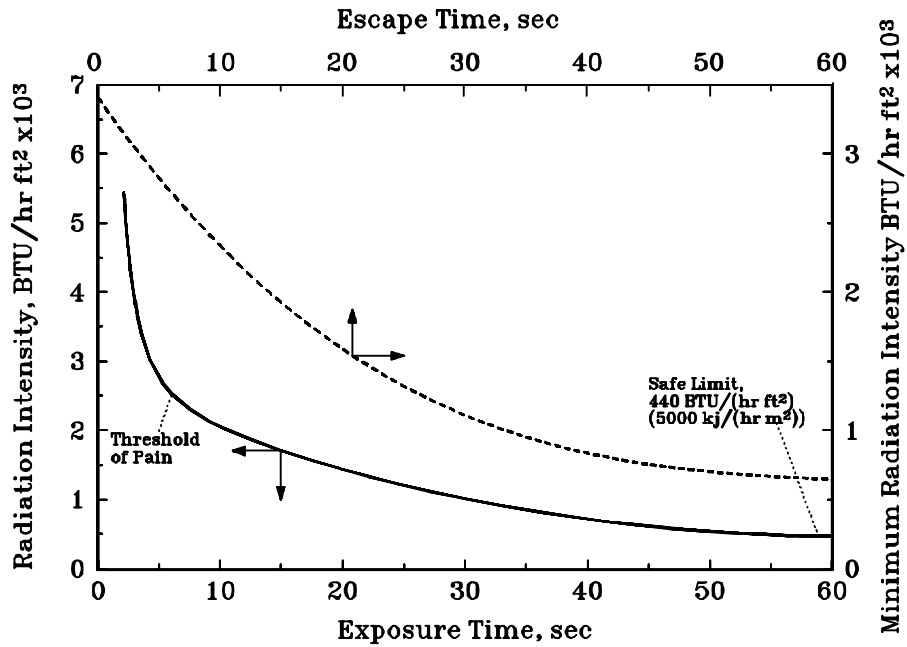

Figure A2.5
Radiation Intensity as a Function of Exposure Time or Escape Time

Source:

Kent, G. R. "Find Radiation Effects of Flares," *Hydrocarbon Processing*. 47 (6), (1968): pp. 119-130.

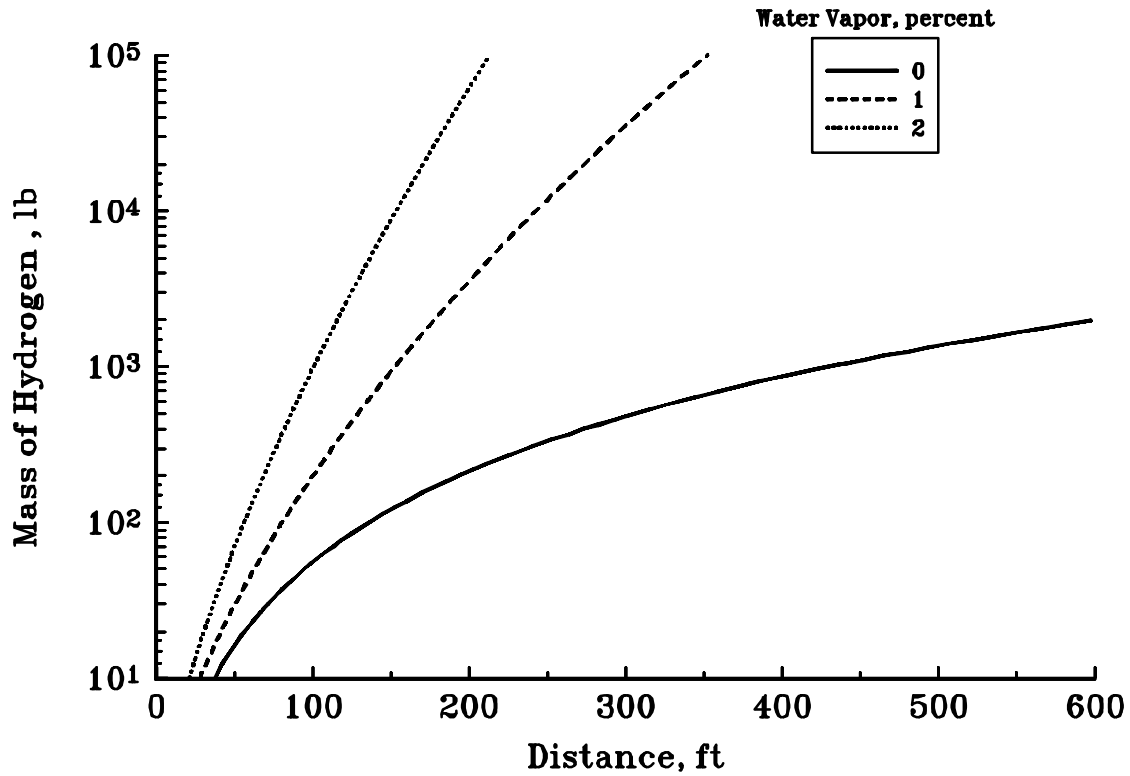

Figure A2.6

Variation in Distance from a Hydrogen Fire for a Thermal Radiation Exposure of 2 cal/cm^2 for an Exposure Duration of 10 s

Note: 2 cal/cm^2 is roughly the radiant flux required to produce flesh burns and ignite certain combustible materials in short exposure times where $2 \text{ cal/cm}^2 = 8.4 \text{ J/cm}^2$ (0.051 Btu/in^2).

Source:

Zebetakis, M. G. and D. S. Burgess. *Research on the Hazards Associated With the Production and Handling of Liquid Hydrogen*. BM-RI-5707, Bureau of Mines Report of Investigation, Washington, DC (1961).

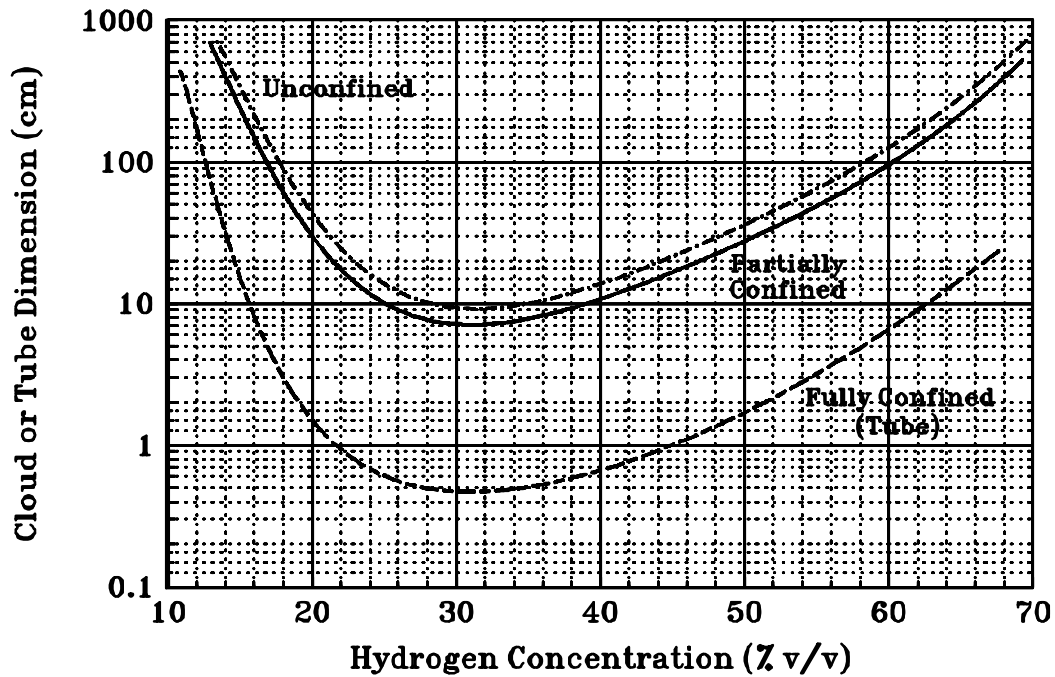

Figure A2.7
 Minimum Dimensions of H_2 -Air Mixtures for Detonation
 at 101.3 kPa (14.7 psia) and 298 K (77 °F)

Source:

Lee, J. H., R., Kynstantus, C. M. Guirao, W. A. Benedick, and J. E. Shepherd. "Hydrogen-Air Detonations." Proceedings of the 2nd International Workshop on the Impact of Hydrogen on Water Reactor Safety. M. Berman, Ed., SAND82-2456, Sandia National Laboratories, Albuquerque, NM, October (1982).

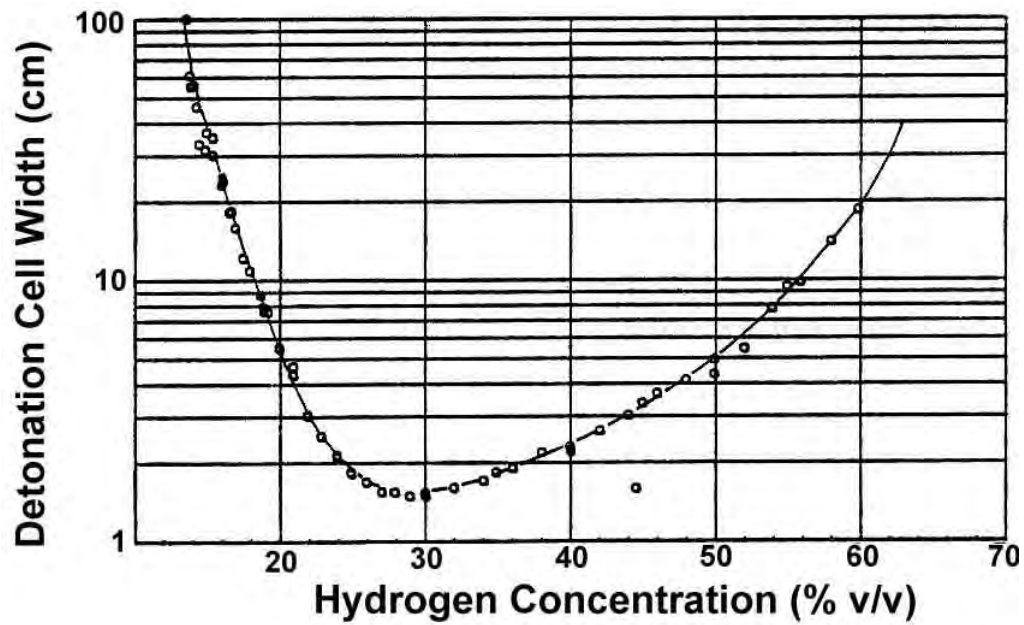

Figure A2.8
 Detonation Cell Widths for Hydrogen-Air Mixtures at 101.3 kPa (14.7 psia)

Source:

Lee, J. H., R. Kynstantus, C. M. Guirao, W. A. Benedick, and J. E. Shepherd. "Hydrogen-Air Detonations." *Proceedings of the 2nd International Workshop on the Impact of Hydrogen on Water Reactor Safety*. M. Berman, Ed., SAND82-2456, Sandia National Laboratories, Albuquerque, NM, October (1982).

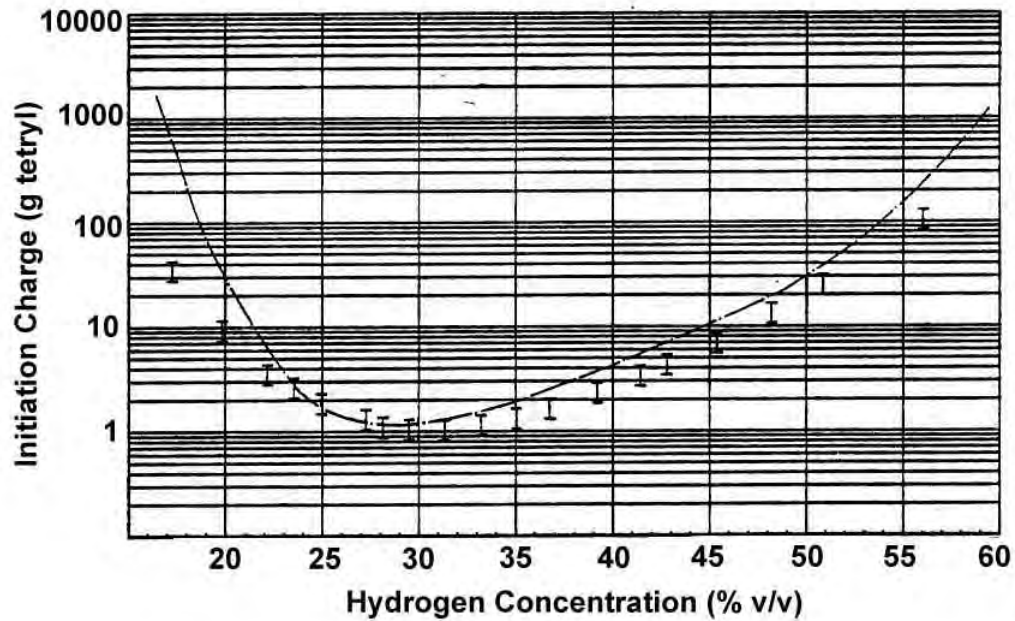

Figure A2.9

Minimum Initiation Energies for Direct Detonation of Hydrogen-Air Mixtures

Source:

Lee, J. H., R. Kynstantus, C. M. Guirao, W. A. Benedick, and J. E. Shepherd. "Hydrogen-Air Detonations." Proceedings of the 2nd International Workshop on the Impact of Hydrogen on Water Reactor Safety. M. Berman, Ed., SAND82-2456, Sandia National Laboratories, Albuquerque, NM, October (1982).

Table A2.1
Potential Ignition Sources^a

Thermal Ignition	Electrical Ignition
Personnel smoking	Electrical short circuits, sparks, and arcs
Open flames	Metal fracture
Shock waves from tank rupture	Static electricity (two-phase flow)
Fragments from bursting vessels	Static electricity (flow with solid particles)
Heating of high-velocity jets	Lightning
Welding	Generation of electrical charge by equipment operations
Explosive charges	
Friction and galling	
Resonance ignition (repeated shock waves in a flow system)	
Mechanical impact	
Tensile rupture	
Mechanical vibration	
Exhaust from thermal combustion engine	

^a Ordin, P. M. "Safety," Chapter 1, *Liquid Cryogenics, Vol 1, Theory and Equipment*. K. D. Williamson, Jr. and F. J. Edeskuty, Eds., CRC Press, Boca Raton, FL (1983).

Table A2.2
Flammability Limits

	Upward Propagation		Downward Propagation		Horizontal Propagation	
	Lower Limit	Upper Limit	Lower Limit	Upper Limit	Lower	Upper Limit
Hydrogen Content (vol %)						
Hydrogen in air and oxygen at 101.3 kPa (14.7 psia):						
H ₂ + air:						
Tubes	4.1	74.8	8.9	74.5	6.2	71.3
Spherical Vessels	4.6	75.5	---	---	---	---
H ₂ + oxygen	4.1	94.0	4.1	92.0	---	---
Hydrogen plus inert gas mixtures at 101.3 kPa (14.7 psia):						
H ₂ + He+ 21 vol% O ₂	7.7	75.7	8.7	75.7	---	---
H ₂ + CO ₂ + 21 vol% O ₂	5.3	69.8	13.1	69.8	---	---
H ₂ + N ₂ + 21 vol% O ₂	4.2	74.6	9.0	74.6	---	---
Hydrogen in air at reduced pressure with a 45 mJ (47.5 Btu) ignition source:						
Pressure (kPa)	25 cm Tube		2 L Sphere			
	Lower Limit	Upper Limit	Lower Limit	Upper Limit		
20	≈ 4	≈ 56	≈ 5	≈ 52		
10	≈ 10	≈ 42	≈ 11	≈ 35		
7	≈ 15	≈ 33	≈ 16	≈ 27		
6	20-30		20-25 (at 6.5 kPa)			
Note: Dashes indicate no information available.						

Source:

Benz, F. J., C. V. Bishop, and M. D. Pedley. *Ignition and Thermal Hazards of Selected Aerospace Fluids: Overview, Data, and Procedures*. NASA White Sands Test Facility, Las Cruces, NM (1988).

Table A2.3
Effects of Diluents^a on Flammable Range for Hydrogen in Air

Tube Diameter, cm (in.)	Rating of Diluents at Reducing Flammable Range			
Wide tubes	CO ₂	< N ₂	< He	< Ar ^b
2.2 (0.87)	CO ₂	< He	< N ₂	< Ar ^b
1.6 (0.63)	He	< CO ₂	< N ₂	< Ar ^b

^a Equal concentrations
^b Ar is the least effective in reducing the flammable range.

Source:

Mellish, C. E. and J. W. Linnett. "The Influence of Inert Gases on Some Flame Phenomena." Proceedings of the 4th Symposium (International) Combustion, Baltimore, MD (1953): pp. 407-420.

Table A2.4
Inhibitor for Extinction of Hydrogen Diffusion Flames

Inhibitor	Concentration at Flame Extinction (vol%)
Added to air:	
Nitrogen	94.1
CH ₃ Br	11.7
CBrF ₃	17.7
Added to fuel:	
Nitrogen	52.4
CH ₃ Br	58.1
CBrF ₃	56.6

Source:

Creitz, E. C. "Inhibition of Diffusion Flames by Methyl Bromide and Trifluoromethyl-Bromide Applied to the Fuel and Oxygen Sides of the Reaction Zone." *Journal of Research for Applied Physics and Chemistry*, 65A (1961): pp. 389-396.

Table A2.5
Critical Radiant Flux Levels

Radiant flux		Effect
W/cm ² (Btu/h/ft ²)		
0.473	(1500)	Pain felt in 15-30 s (skin burns in 30 s)
1.167	(3700)	Thin steel with insulated backing can undergo failure
1.260	(4000)	Minimum flux - wood ignition
2.30	(7300)	Uninsulated steel - undergoes structural failure
5.86	(18000)	Fiber insulating board - ignition after 3 s exposure
4.35	(14000)	Fiber insulating board - ignition after 7 s exposure
3.35	(11000)	Cotton fabrics - ignition after 7 s exposure
NOTE: Safe limit for extended exposure - 0.139 W/cm ² (440 Btu/h/ft ²). For exposures from 10-30 s: 1 st degree burns ≈ 2-4 cal/cm ² or 8.4-16.7 J/cm ² (0.0051-0.102 Btu/in ²) 2 nd degree burns ≈ 4-8 cal/cm ² or 8.4-16.7 J/cm ² (0.0051-0.102 Btu/in ²).		

Source:

Ordin, P. M. "Safety," Chapter 1, *Liquid Cryogenics, Vol 1, Theory and Equipment*, K. D. Williamson, Jr. and F. J. Edeskuty, Eds. CRC Press, Boca Raton, FL (1983).

A.3 HYDROGEN STORAGE SITING

Table A3.1
Order of Preference for Location of GH₂ Storage Systems^{a,b}

Nature of Location	GH ₂ Volume		
	Less Than 3000 ft ³ (85 m ³)	3000 to 15000 ft ³ (85 to 425 m ³)	Over 15000 ft ³ (425 m ³)
Outdoors	I	I	I
In separate building	II	II	II
In special room	III	III	Not permitted
Inside buildings, but not in a special room and exposed to other occupancies.	IV	Not permitted	Not permitted

^a 29 CFR 1910.103 (1996) and NFPA 50A (1994)

^b The location of GH₂ storage, as determined by the maximum total quantity of GH₂, shall be in the order of preference indicated by Roman numerals with I indicating the most preferred and IV the least preferred location.

Table A3.2
Quantity-Distance Requirements for Nonpropellant GH₂ Systems for Outdoor Locations^a

Type of Outdoor Exposure ^{g,h}	Size of Gaseous Hydrogen System			
	Less than 3000 CF (85 CM)	3,000 CF (85 CM) to 15000 CF (425 CM)	In Excess of 15000 CF (425 CM)	
1. Building or structure	a) Wall(s) adjacent to system constructed of noncombustible or limited-combustible materials.			
	1) Sprinklered building or structure, or contents non-combustible.	0 ^b	5 ft (1.5 m) ^b	5 ft (1.5 m) ^b
	2) Unsprinklered building or structure with combustible contents.			
	Adjacent wall(s) with fire-resistance rating less than 2 h ^c	0 ^d	10 ft (3 m)	25 ft (7.6 m) ^e
	Adjacent wall(s) with fire-resistance rating of 2 h or greater. ^c	0	5 ft (1.5 m)	5 ft (1.5 m)
	b) Wall(s) adjacent to system constructed of other than non-combustible or limited materials.	10	25 ft (7.6 m)	50 ft (15 m) ^e
2. Wall Openings	Not above any part of a system	10 ft (3 m)	10 ft (3 m)	10 ft (3 m)
	Above any part of a system	25 ft (7.6 m)	25 ft (7.6 m)	25 ft (7.6 m)
3. All classes of flammable and combustible liquids above ground.	0 - 1000 gal (3785 L)	10 ft (3 m) ^f	10 ft (3 m) ^f	10 ft (3 m) ^f
	In excess of 1000 gal (3785 L)	25 ft (7.6 m) ^f	25 ft (7.6 m) ^f	25 ft (7.6 m) ^f
4. All classes of flammable and combustible liquids below ground — 0-1000 gal (0-3785 L)	Tank	10 ft (3 m) ^f	10 ft (3 m) ^f	10 ft (3 m) ^f
	Vent or fill opening of tank	25 ft (7.6 m) ^f	25 ft (7.6 m) ^f	25 ft (7.6 m) ^f
5. All classes of flammable and combustible liquids below ground - in excess of 1000 gal (3785 L)	Tank	20 ft (6 m) ^f	20 ft (6 m) ^f	20 ft (6 m) ^f
	Vent or fill opening of tank	25 ft (7.6 m) ^f	25 ft (7.6 m) ^f	25 ft (7.6 m) ^f
6. Flammable gas storage (other than hydrogen), high pressure or low pressure.	0-15000 CF (255 CM) capacity	10 ft (3 m)	25 ft (7.6 m)	25 ft (7.6 m)
	In excess of 15000 CF (255 CM) capacity	25 ft (7.6 m)	50 ft (15 m)	50 ft (15 m)
7. Oxygen Storage	20000 CF (566 CM) or less	Refer to NFPA 51		
	More than 20000 CF (566 CM)	Refer to NFPA 50		
8. Fast burning solids such as ordinary lumber, excelsior, or paper	50 ft (15 m)	50 ft (15 m)	50 ft (15 m)	
9. Slow burning solids such as heavy timber or coal	25 ft (7.6 m)	25 ft (7.6 m)	25 ft (7.6 m)	
10. Open flames and welding	25 ft (7.6 m)	25 ft (7.6 m)	25 ft (7.6 m)	
11. Air compressor intakes or inlets to ventilating or air-conditioning equipment	50 ft (15 m)	50 ft (15 m)	50 ft (15 m)	
12. Places of public assembly	25 ft (7.6 m)	25 ft (7.6 m)	25 ft (7.6 m)	
13. Public sidewalks and parked vehicles	15 ft (4.6 m)	15 ft (4.6 m)	15 ft (4.6 m)	
14. Line of adjoining property which may be built upon	5 ft (1.5 m)	5 ft (1.5 m)	5 ft (1.5 m)	

^a NFPA 50A (1994).

^b Portions of wall less than 10 ft (3 m) (measured horizontally) from any part of a system shall have a fire-resistance rating of at least one-half hour.

^c Exclusive of windows and doors.

^d Portions of walls less than 10 ft (3 m) (measured horizontally) from any part of a system shall have a fire resistance rating of at least 1 h.

^e But not less than one half the height of adjacent wall or building or structure.

^f Distances may be reduced to 15 ft (4.6 m) for Class IIIB combustible liquids. Class IIIB liquids include those having a closed cup flash point at or above 200 °F (366.5 K).

^g The distances in exposure types 1, 3 through 10, and 14 shall not apply where protective structures having a minimum fire-resistance rating of 2 h are located between the system and exposure.

^h Unloading connections on delivery equipment shall not be positioned closer to any of the exposures cited than the distances given for the storage system.

Table A3.3
Order of Preference for Location of LH₂ Storage Systems^{a, b, c}

Nature of Location	LH ₂ Volume, L (gal)			
	150 (39.63) to 189 (50)	190 (51) to 1136 (300)	1137 (301) to 2271 (600)	In excess of 2271 (600)
Outdoors	I	I	I	I
In separate building	II	II	II	Not permitted
In special room	III	III	Not permitted	Not permitted
Inside buildings, but not in a special room and exposed to other occupancies.	IV	Not permitted	Not permitted	Not permitted

^a 29 CFR 1910.103 and NFPA 50B (1994).

^b This table does not apply to the storage in dewars of the type generally used in laboratories for experimental purposes.

^c The location of LH₂ storage, as determined by the maximum total quantity of LH₂, shall be in the order of preference indicated by Roman numerals with I indicating the most preferred and IV the least preferred location.

Table A3.4
Quantity-Distance^a Requirements for Nonpropellant LH₂ Systems for Outdoor Locations^{b,c}

Type of Outdoor Exposure ^h	Total Liquid Hydrogen Storage Capacity (gal)		
	39.65 to 3500	3501 to 15,000	15,001 to 75,000
1. Building/structure			
a) Wall(s) adjacent to system constructed of non combustible materials or limited combustible materials.			
(1) Sprinklered building/structure or unsprinklered building/structure having noncombustible contents.	5 ^{d,f}	5 ^{d,f}	5 ^{d,f}
(2) Unsprinklered building/structure with combustible contents. Adjacent wall(s) with fire resistance rating less than 3 hr. ^e	25 5	50 5	75 5
Adjacent wall(s) with fire resistance rating of 3 hr or greater. ^e			
b) Wall(s) adjacent to system constructed of combustible materials	50	50	50
(1) Sprinklered building/structure	50	75	100
(2) Unsprinklered building/structure			
2. Wall openings			
a) Openable	75	75	75
b) Unopenable	25	50	50
3. Air compressor intakes, inlets for air conditioning or ventilating equipment.	75	75	75
4. All classes of flammable and combustible liquids (above ground and vent or fill openings if below ground).	50 ^g	75 ^g	100 ^g
5. Between stationary liquefied hydrogen containers	5	5	5
6. Flammable gas storage (other than hydrogen)	50	75	75
7. Liquid oxygen storage and other oxidizers	75	75	75
8. Combustible solids	50	75	100
9. Open flames and welding	50	50	50
10. Places of public assembly	75	75	75
11. Public ways, railroads, and property lines	25	50	75
12. Inlet to underground sewers	5	5	5
13. Protective structures	5 ^f	5 ^f	5 ^f

^a Distances are given in units of feet.

^b NFPA 50B (1994).

^c The distances in exposure types 1, 4, 6, 7, 8, and 11 shall be permitted to be reduced by two thirds, but to not less than 5 ft (1.5 m), for insulated portions of the system; and, for uninsulated portions of the system, by the use of protective structures having a minimum fire resistance rating of 2 h, which interrupts the line of sight between the uninsulated portions of the LH₂ system and the exposure. The protective structure, or the insulated LH₂ tank, shall interrupt the line of sight between uninsulated portions of the LH₂ storage system and the exposure.

^d Portions of wall less than 10 ft (3 m) (measured horizontally) from any part of a system shall have a fire resistance rating of at least one-half hour.

^e Exclusive of windows and doors.

^f Where protective structures are provided, ventilation and confinement of product shall be considered. The 5 ft (1.5 m) distance in exposure types 1 and 13 facilitates maintenance and enhances ventilation.

^g Distances may be reduced to 15 ft (4.6 m) for Class IIIB combustible liquids (liquids having a flash point at or above 366.5 K (200 °F)).

^h Unloading connections on delivery equipment shall not be positioned closer to any of the exposures cited than the distances given for the storage system.

Table A3.5
Liquid Propellant Hazard and Compatibility Groups^f

Propellant	Hazard Group ^a	Storage Compatibility Group ^b
Alcohols (CH ₃ OH, C ₂ H ₅ OH, and (CH ₃) ₂ CHOH)	I	C
Anhydrous ammonia (NH ₃)	I	C
Aniline (C ₆ H ₅ NH ₂)	I	C
Hydrocarbon fuels (JP-4, JP-5, and RP-1)	I	C
Monopropellant (NOS-58-6)	I	C
Nitrogen tetroxide (N ₂ O ₄)	I	A
Otto fuel II	I	G
Red fuming nitric acid (HNO ₃)	I	A
Triethylboron (B(C ₂ H ₅) ₃)	I	D
Bromine pentafluoride (BrF ₅)	II	A
Chlorine trifluoride (ClF ₃)	II	A
Hydrogen peroxide (H ₂ O ₂) greater than 52%	II ^c	A
Liquid fluorine (LF ₂)	II	A
Liquid oxygen (LO ₂)	II	A
Perchloryl fluoride (ClO ₃ F)	II	A
Oxygen difluoride (OF ₂)	II	A
Ozone difluoride (O ₂ F ₂)	II	A
Ethylene oxide (C ₂ H ₄ O)	III	D
Hydrazine (N ₂ H ₄)	III	C
Hydrazine and unsymmetrical dimethyl-hydrazine (UDMH) mixtures	III	C
Liquid hydrogen (LH ₂)	III	C
Mixed amine fuels	III	C
Monomethylhydrazine (CH ₂ NHNH ₃)	III	C
Pentaborine (B ₅ H ₉)	III	D
UDMH ((CH ₃) ₂ NNH ₂)	III	C
Nitromethane (CH ₃ NO ₂)	IV ^d	F ^e
Tetranitromethane (C(NO ₂) ₄)	IV	F

^a The toxic hazard may be an overriding consideration for some materials listed. Consult applicable regulations and, if necessary, other authorities or publications for toxic siting criteria.

^b Propellants with same compatibility group letter are considered as compatible propellants and those with unlike letters incompatible.

^c Concentrations of hydrogen peroxide greater than 90% can detonate under certain conditions. However, its sensitivity to detonation is no greater than that of standard energetic double base solid propellant under the same conditions.

^d Technical grade or better nitromethane in unit quantities of 55 gal (208 L) or less in DOT 17E or C drums may be stored using hazard group II distances provided drums are stored only one tier high, drums are protected from direct rays of the sun, and a maximum storage life of 2 years is enforced unless storage life tests indicate that products meet purchase specifications at that time. Such tests are to be repeated at 1-year intervals thereafter.

^e Nitromethane is chemically compatible with storage compatibility group C liquid propellants; however, differences in hazards require nitromethane be stored separately.

^f DoD 6055.9 (1992), NSS 1740.12 (1993).

Table A3.6
Explosive Equivalent Factors for Liquid Propellants^{a, b}

Propellant Combinations	Static Test Stands	Range Launch Pads
LO ₂ /LH ₂	60%	60%
LO ₂ /LH ₂ + LO ₂ /RP-1 ^d	60% for LO ₂ /LH ₂ + 10% for LO ₂ /RP-1 ^d	60% for LO ₂ /LH ₂ + 20% for LO ₂ /RP-1 ^d

^a NSS 1740.12 (1993), DoD 6055.9 (1992).

^b The percentage factors given in the table are to be used to determine the equivalencies of propellant mixtures at static test stands and range launch pads when such propellants are located above ground and are unconfined except for their tankage. Other configurations shall be considered on an individual basis to determine the equivalencies.

^c For quantities of propellant up to but not over the equivalent of 45 kg (100 lb) of explosives, the distance shall be determined on an individual basis by the authority having jurisdiction at the controlling NASA center. All personnel and facilities, involved in the operation or not, shall be adequately protected by proper operating procedures, equipment design, shielding, barricading, or other suitable means.

^d Alcohols or other hydrocarbons may be substituted for RP-1.

Table A3.7
Safe Quantity-Distance Relationships for LH₂ Storage for Hazard Group III Materials^a

Pounds of Propellant		Inhabited Buildings, Public Traffic Routes, and Incompatible Group III Storage Distance (ft)		Intragroup ^e and Compatible Group III
Over	Not Over	Unprotected ^b	Protected ^{c,d}	Distance (ft)
Column 1	Column 2	Column 3	Column 4	Column 5
0	100	600	80	30
100	200	600	100	35
200	300	600	110	40
300	400	600	120	45
400	500	600	130	50
500	600	600	135	50
600	700	600	140	55
700	800	600	145	55
800	900	600	150	60
900	1,000	600	150	60
1,000	2,000	600	175	65
2,000	3,000	600	190	70
3,000	4,000	600	200	75
4,000	5,000	600	210	80
5,000	6,000	600	220	80
6,000	7,000	600	225	85
7,000	8,000	600	230	85
8,000	9,000	600	235	90
9,000	10,000	600	240	90
10,000	15,000	1200	260	95
15,000	20,000	1200	275	100
20,000	25,000	1200	285	105
25,000	30,000	1200	295	110
30,000	35,000	1200	300	110
35,000	40,000	1200	310	115
40,000	45,000	1200	315	120
45,000	50,000	1200	320	120
50,000	60,000	1200	330	125
60,000	70,000	1200	340	130
70,000	80,000	1200	355	130
80,000	90,000	1200	360	135
90,000	100,000	1200	365	135
100,000	125,000	1800	380	140
125,000	150,000	1800	395	145
150,000	175,000	1800	405	150
175,000	200,000	1800	415	155
200,000	250,000	1800	425	160
250,000	300,000	1800	440	165
300,000	350,000	1800	455	170
350,000	400,000	1800	465	175
400,000	450,000	1800	475	180
450,000	500,000	1800	485	180
500,000	600,000	1800	500	185
600,000	700,000	1800	515	190

Table A3.7 (continued)
 Safe Quantity-Distance Relationships for LH₂ Storage for Hazard Group III Materials^a

Pounds of Propellant		Inhabited Buildings, Public Traffic Routes, and Incompatible Group III Storage Distance (ft)		Intragroup ^e and Compatible Group III Distance (ft)
Over	Not Over	Unprotected ^b	Protected ^{c,d}	
Column 1	Column 2	Column 3	Column 4	Column 5
700,000	800,000	1800	530	195
800,000	900,000	1800	540	200
900,000	1,000,000	1800	550	205
1,000,000 ^f	2,000,000	1800	630	235
2,000,000	3,000,000	1800	675	255
3,000,000	4,000,000	1800	710	265
4,000,000	5,000,000	1800	740	275
5,000,000	6,000,000	1800	760	285
6,000,000	7,000,000	1800	780	295
7,000,000	8,000,000	1800	800	300
8,000,000	9,000,000	1800	815	305
9,000,000	10,000,000	1800	830	310

^a From NSS 1740.12, Table 7-5.

^b Distances are necessary to provide reasonable protection from fragments of tanks or equipment that are expected to be thrown in a vapor-phase explosion.

^c The term "protected" means that protection from fragments is provided by terrain, effective barricades, nets, or other physical means.

^d Distances are recommended inhabited building distances and extrapolation thereof (2 cal/cm² on 1% water vapor curve) (Zabetakis and Burgess 1961).

^e This applies to storage of liquid propellants in all types of containers, including missile tankage, in quantities greater than single minimum-size shipping containers such as one 55 gal (208 L) drum or one 500 lb (226.8 kg) (net weight) cylinder. Smaller quantities shall be stored and handled as prescribed by controlling NASA center.

^f Extrapolation above 1,000,000 lb (453,590 kg) extended well outside data from which original quantity-distance tables were derived (Zabetakis and Burgess 1961); however, they are supported by independent calculation and knowledge of like phenomena.

Table A3.8
Separation and Intraline Quantity-Distance Values for Mixed Propellants^a

Weight of Explosives or Group IV Propellant (lb) Column 1	Distance from Propellant and Explosives Hazard (ft)			
	To Inhabited Buildings Column 2	To Public Traffic Routes Column 3	Intraline	
			Barricaded Column 4	Unbarricaded Column 5
≤100	--- ^b	--- ^b	--- ^b	--- ^b
>100	190	115	40	80
200	235	140	50	100
300	270	160	60	120
400	295	175	65	130
500	320	190	70	140
600	340	205	75	150
700	355	215	80	160
800	375	225	85	170
900	390	235	90	180
1,000	400	240	95	190
1,500	460	275	105	210
2,000	505	305	115	230
3,000	580	350	130	260
4,000	635	380	140	280
5,000	685	410	150	300
6,000	730	440	160	320
7,000	770	460	170	340
8,000	800	480	180	360
9,000	835	500	190	380
10,000	865	520	200	400
15,000	990	595	225	450
20,000	1090	655	245	490
25,000	1170	700	265	530
30,000	1245	745	280	560
35,000	1310	785	295	590
40,000	1370	820	310	620
45,000	1425	855	320	640
50,000	1475	885	330	660
55,000	1520	910	340	680
60,000	1565	940	350	700
65,000	1610	965	360	720
70,000	1650	990	370	740
75,000	1685	1010	385	770
80,000	1725	1035	390	780
85,000	1760	1055	395	790
90,000	1795	1075	400	800
95,000	1825	1095	410	820
100,000	1855	1115	415	830
125,000	2115	1270	450	900
150,000	2350	1410	475	950
175,000	2565	1540	500	1000
200,000	2770	1660	525	1050

Table A3.8 (continued)Separation and Intraline Quantity-Distance Values for Mixed Propellants^a

Weight of Explosives or Group IV Propellant (lb) Column 1	Distance in Feet from Propellant and Explosives Hazard (ft)			
	To Inhabited Buildings Column 2	To Public Traffic Routes Column 3	Intraline	
			Barricaded Column 4	Unbarricaded Column 5
225,000	2965	1780	545	1090
250,000	3150	1890	565	1135
275,000	3250	1950	585	1170
300,000	3345	2005	600	1200
325,000	3440	2065	620	1240
350,000	3525	2115	635	1270
375,000	3605	2165	650	1300
400,000	3685	2210	665	1330
425,000	3760	2250	680	1355
450,000	3830	2300	690	1380
475,000	3900	2340	700	1405
500,000	3970	2380	715	1670
600,000	4220	2530	760	1520
700,000	4440	2660	800	1600
800,000	4640	2780	835	1670
900,000	4830	2900	870	1740
1,000,000	5000	3000	900	1800
2,000,000	6300	3780	1135	2270
2,500,000	6790	4070	1220	2440
3,000,000	7210	4330	1300	2600
3,500,000	7590	4550	1365	2730
4,000,000	7935	4760	1430	2860
5,000,000	8550	5130	1540	3080

^a From NSS 1740.12, Table 7-6 except for weights greater than 20,000 lb. Distances for weights above 20,000 lb from DoD 6055.9, Table 9-1, notes 3 and 7, and Table 9-3.

^b Distance shall be determined on individual basis by the authority having jurisdiction at the controlling NASA Center for quantities of propellant up to but not over equivalent of 100 lb (45 kg) of explosives. All personnel and facilities, involved in operation or not, shall be protected adequately by proper operating procedures, equipment design, shielding, barricading, or other suitable means.

A.4 VENTING AND FLOW OF HYDROGEN

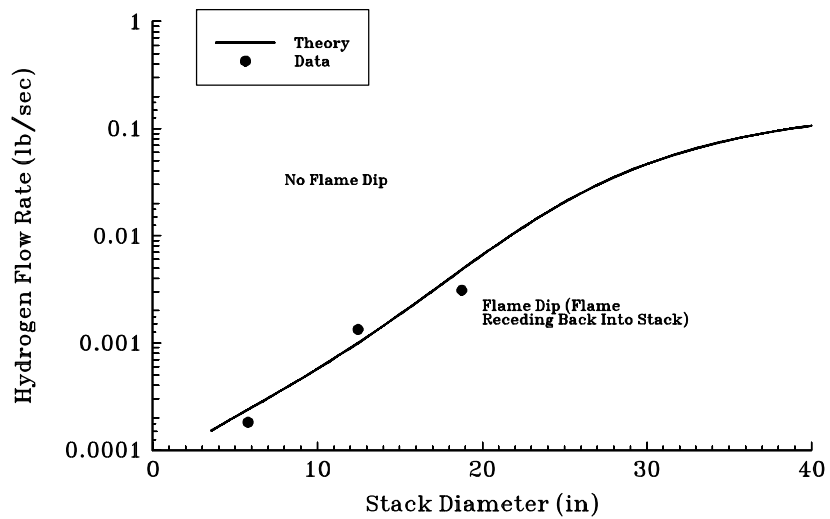

Figure A4.1
Flame Dip as a Function of Stack Diameter and Hydrogen Flow

Source:

Grumer, J., A Strasser, J. M. Singer, P. M. Gussey, and V. R. Rowe, "Hydrogen Flare Stack Diffusion Flames: Low and High Flow Instabilities, Burning Rates, Dilution Limits, Temperatures, and Wind Effects," BM-RI-7457, Bureau of Mines Report of Investigation (1970)

Peterson, P., "Explosions in Flare Stacks." *Chemical Eng. Prog.*, 63(8), August (1967): pp. 67-70.

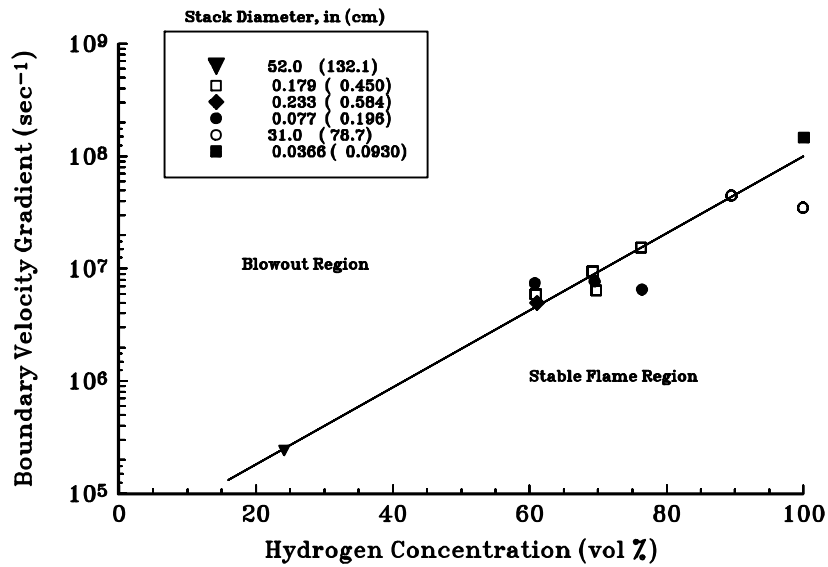

Figure A4.2
Blowout and Stable Flame Region

Source:

Brzustowski, T. A., S. R. Gollahalli, and H. F. Sullivan, "The Turbulent Hydrogen Diffusion Flame in a Cross-Wind," *Comb. Sci. Tech.*, 11(1-2), (1975) pp. 20-33.

Ordin, P. M., and R. C. Carter, "Clinch River Breeder Reactor Hydrogen Disposal and Ignition System," ARSD-00093, General Electric, June (1980).

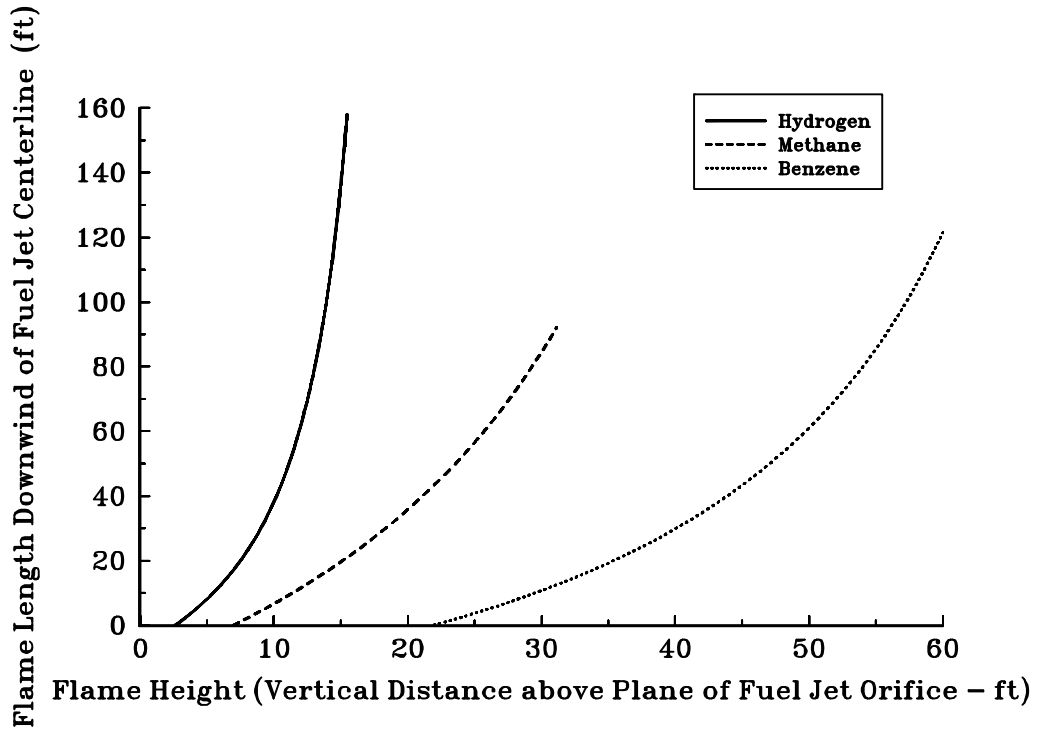

Figure A4.3
Flame Shape in Crosswinds

Source:

Brzustowski, T. A., S R. Gollahalli, and H. F. Sullivan, "The Turbulent Hydrogen Diffusion Flame in a Cross-Wind," *Comb. Sci. Tech.*, 11(1-2), (1975).

Ordin, P. M., and R. C. Carter, " Clinch River Breeder Reactor Hydrogen Disposal and Ignition System," ARSD-00093, General Electric, June (1980).

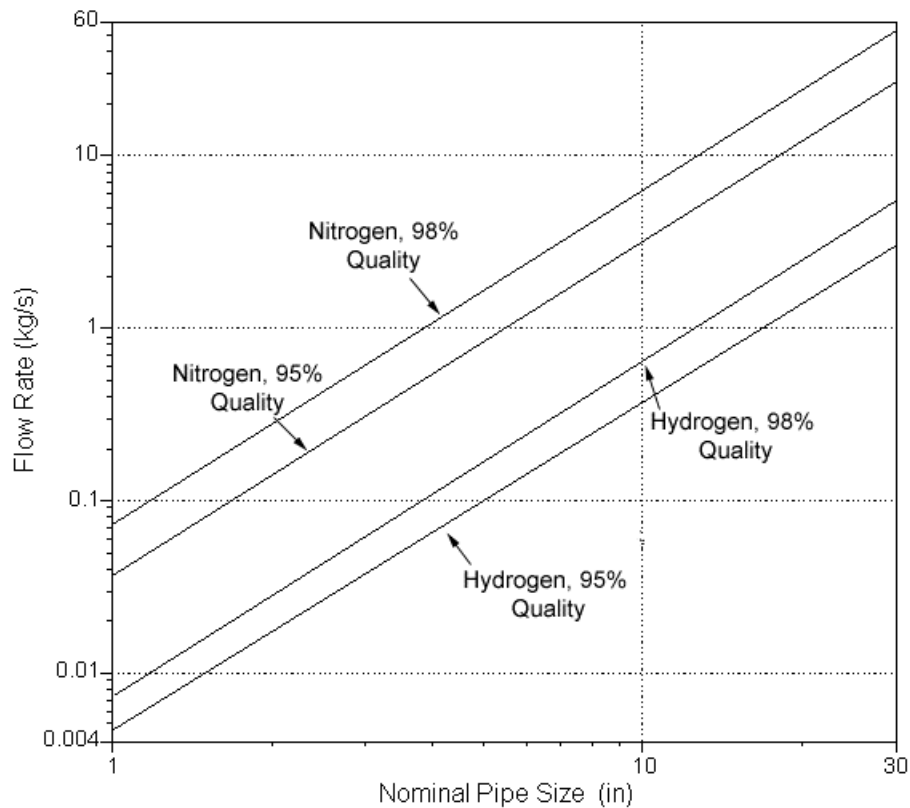

Figure A4.4
Minimum Flow Rate for Non-Stratified, Two Phase Hydrogen and Nitrogen Flow for Pipeline Fluid Qualities Below 95% and 98%^a

^a Liquid and gas phases assumed saturated at normal boiling point.

Source:

Liebenberg, D. H., J. K. Novak, and F. J. Edeskuty. "Cooldown of Cryogenic Transfer Systems." *AIAA 3rd Propulsion Joint Specialist Conference*, AIAA Paper No. 67-475, Washington, DC, July 17-21 (1967).

Novak, J. K. "Cooldown Flow Rate Limits Imposed by Thermal Stresses in Liquid Hydrogen or Nitrogen Pipelines." *Advances in Cryogenic Engineering*, Vol. 15, K. D. Timmerhaus, Ed., Plenum Press, New York (1970): pp. 346-353.

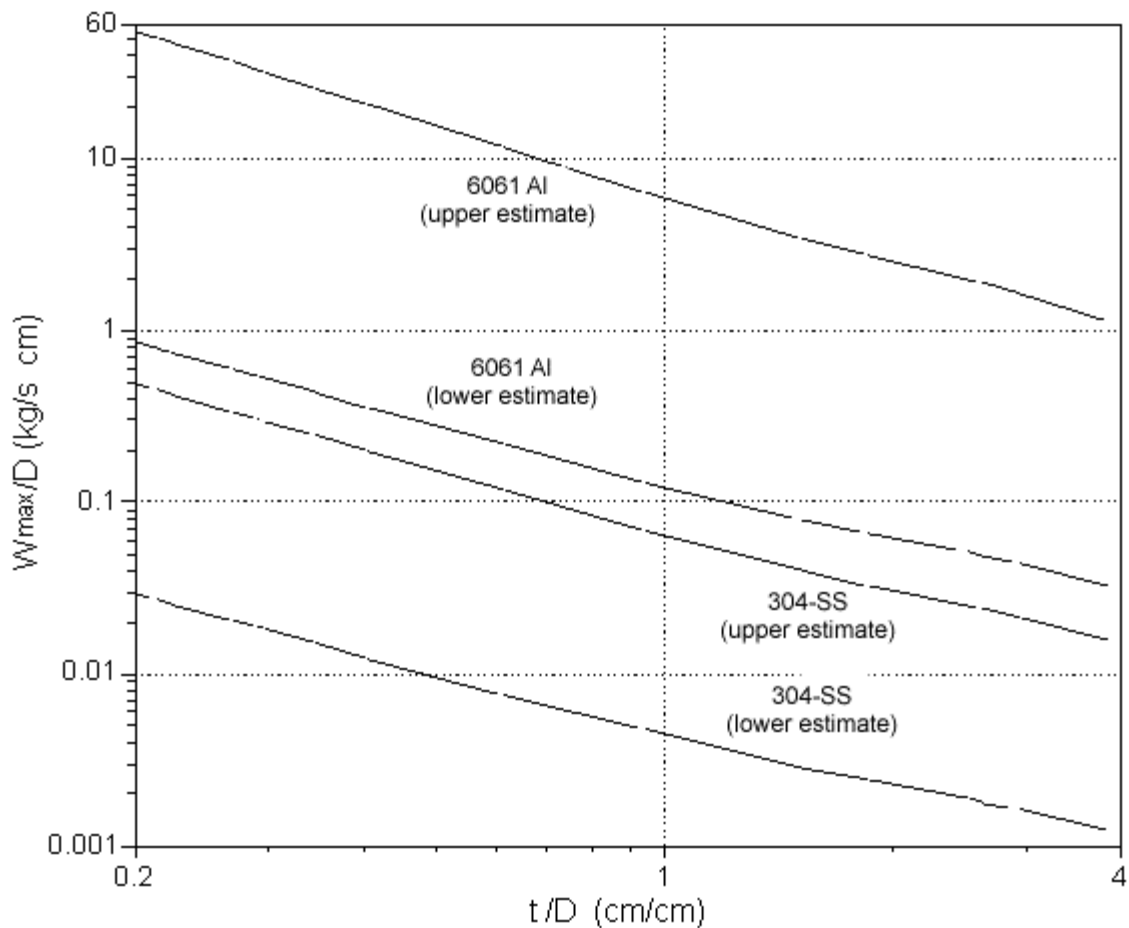

Figure A4.5
Liquid Hydrogen Flow Rate Limits to Avoid Excessive Cooldown Stresses
in Thick-wall Piping Sections such as Flanges for 304 SS and 6061 Al

t = maximum radial thickness of flange wall (cm)
D = inside diameter of flange (cm)
W_{max} = cooldown flow rate limit (kg/s)

Upper and lower estimates represent difference in variables such as heat transfer correlation and limiting stress values.

Source:

Novak, J. K. "Cooldown Flow Rate Limits Imposed by Thermal Stresses in Liquid Hydrogen or Nitrogen Pipelines." *Advances in Cryogenic Engineering*, Vol. 15, K. D. Timmerhaus, Ed., Plenum Press, New York, (1970): pp. 346-353

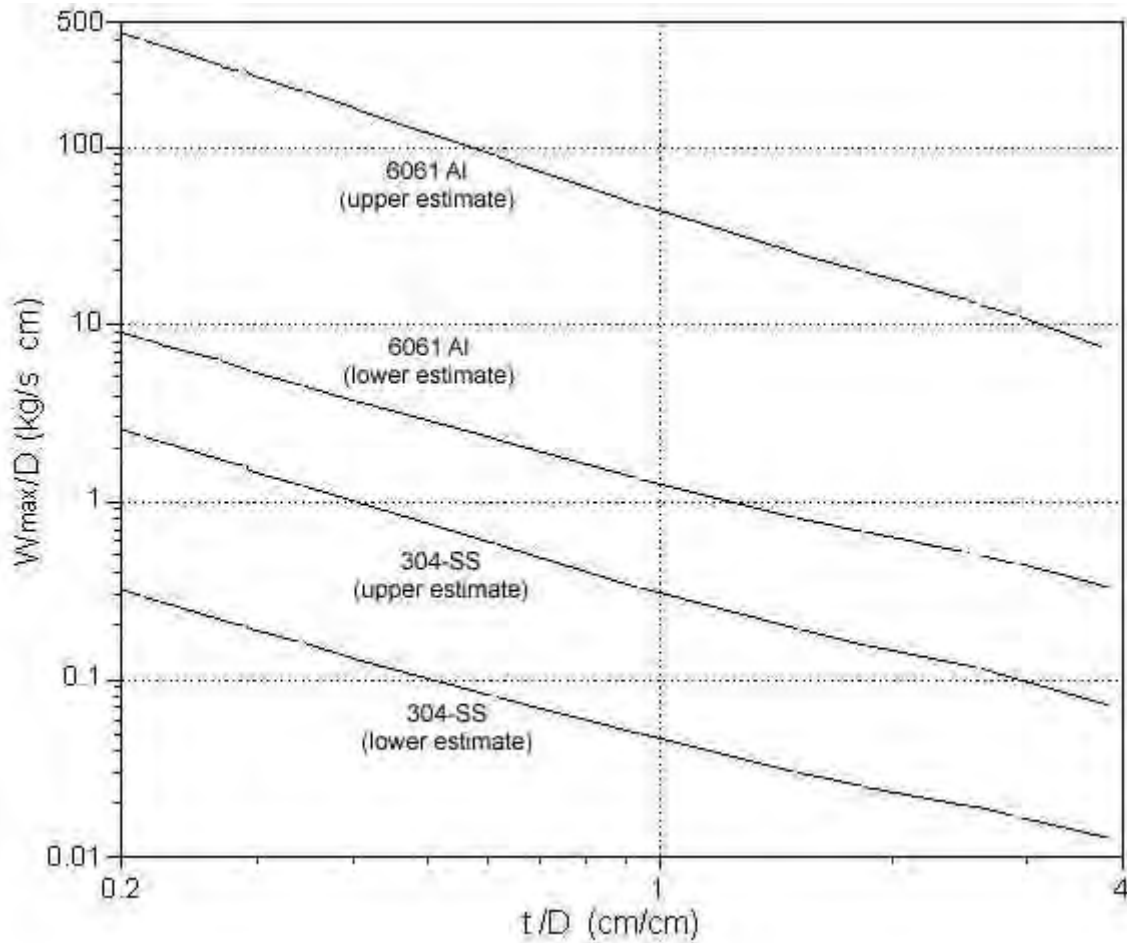

Figure A4.6

Liquid Nitrogen Flow Rate Limits to Avoid Excessive Cooldown Stresses in Thick-wall Piping Sections Such as Flanges for 304 SS and 6061 Al

t = maximum radial thickness of flange wall (cm)

D = inside diameter of flange (cm)

W_{\max} = cooldown flow rate limit (kg/s)

Upper and lower estimates represent difference in variables such as heat transfer correlation and limiting stress values.

Source:

Novak, J. K. "Cooldown Flow Rate Limits Imposed by Thermal Stresses in Liquid Hydrogen or Nitrogen Pipelines." *Advances in Cryogenic Engineering*, Vol. 15, K. D. Timmerhaus, Ed., Plenum Press, New York, (1970): pp. 346-353.

Table A4.1
Summary of Liquefied Hydrogen Spill Data

Size of spill (gal)	Surface	Vaporization	Dispersal	Ignition	Radiation
AD 324/94 ^a					
0.18	Paraffin wax	Yes	No	No	No
1.8	Macadam	No	Visible cloud rise only	No	No
1.8	Gravel	No	Visible cloud rise only	No	No
14.4	Gravel	No	No	Yes	Flame size only
15.4	Steel	No	No	Yes	Flame size only
.8	Macadam	No	Vertical concentrations in quiescent atmosphere	No	No
2.0-23.6	Gravel	No	No	Yes	Flame size and radiant heat flux
BM-RI-5707 ^b					
23.5-44.4	Sand	Yes	No	No	No
35.2	Bank Gravel	Yes	No	No	No
25.0-50.0	Crushed rock	Yes	No	No	No
1.3	Sand	Average	Observations of visible vaporization time cloud	Yes	Fireball size only
32.0	Sand	Average	Observations of visible vaporization time cloud	No	Fireball size only
500.0	Sand	Average	Observations of visible vaporization time cloud	No	Fireball size and radiant heat flux
5000.0	Sand	No	No	Yes ^c	Fireball size and radiant heat flux

^a A. D. Little, Inc., "An Investigation of Hazards Associated with the Storage and Handling of Liquid Hydrogen," AD 324/94, A. D. Little, Inc., Cambridge, MA, March (1960).
^b Zebetakis, M. G., and D. S. Burgess, "Research on the Hazards Associated with the Production and Handling of Liquid Hydrogen," BM-RI-5707, Bureau of Mines Report of Investigation (1961).
^c Inadvertently

A.5 MATERIALS

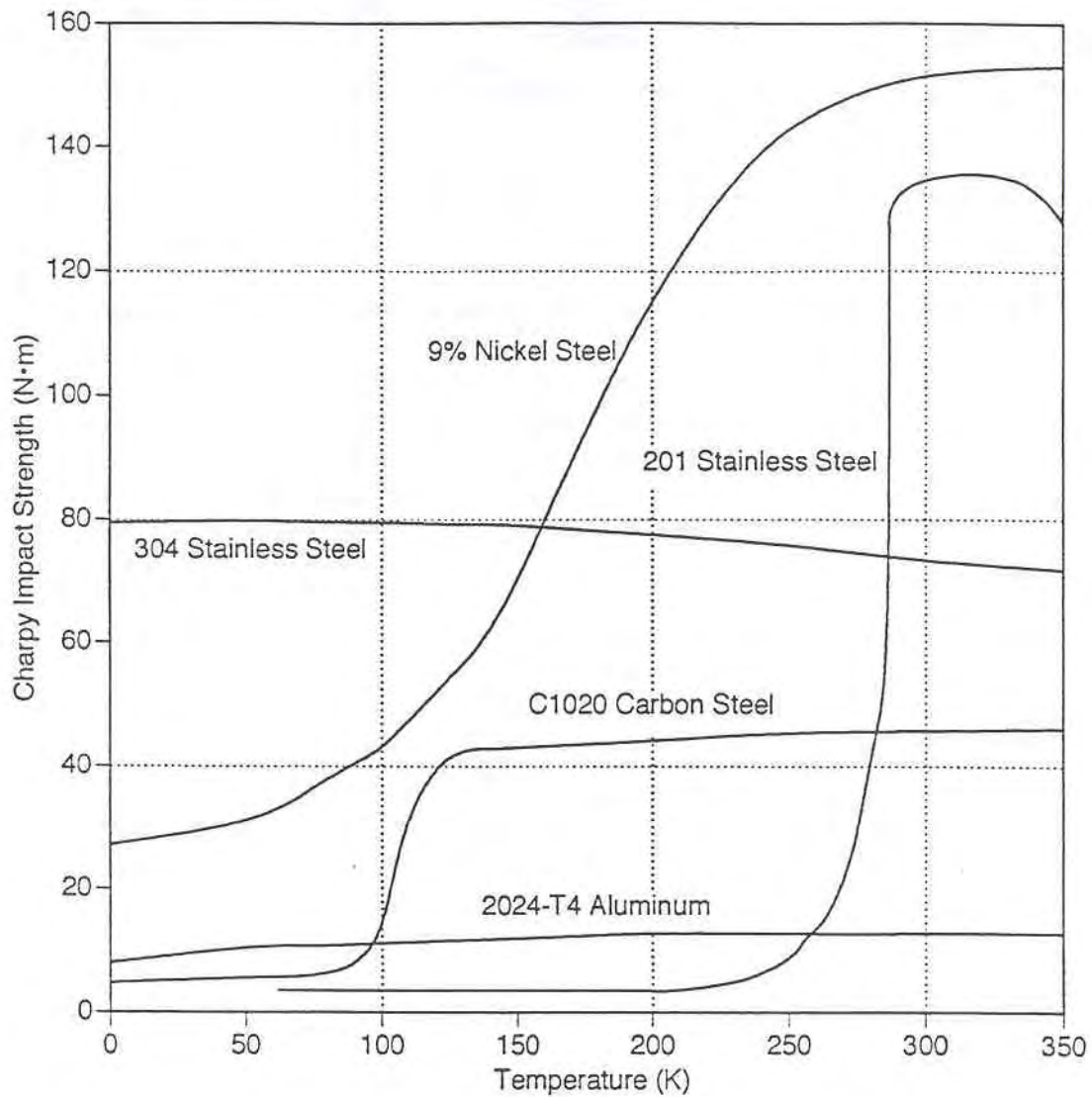

Figure A5.1

Charpy Impact Strength as a Function of Temperature for Various Materials

Source:

Brown, W. F., Jr., H. Mindlin, and C. Y. Ho, Editors. *Aerospace Structural Metals Handbook*. CINDAS/USAF CRDA Handbooks Operation, Purdue University, West Lafayette, IN (1996 Edition).

Durham, T. F., R. M. McClintock, and R. P. Reed. *Cryogenic Materials Data Handbook*. Office of Technical Services, Washington, DC (1962).

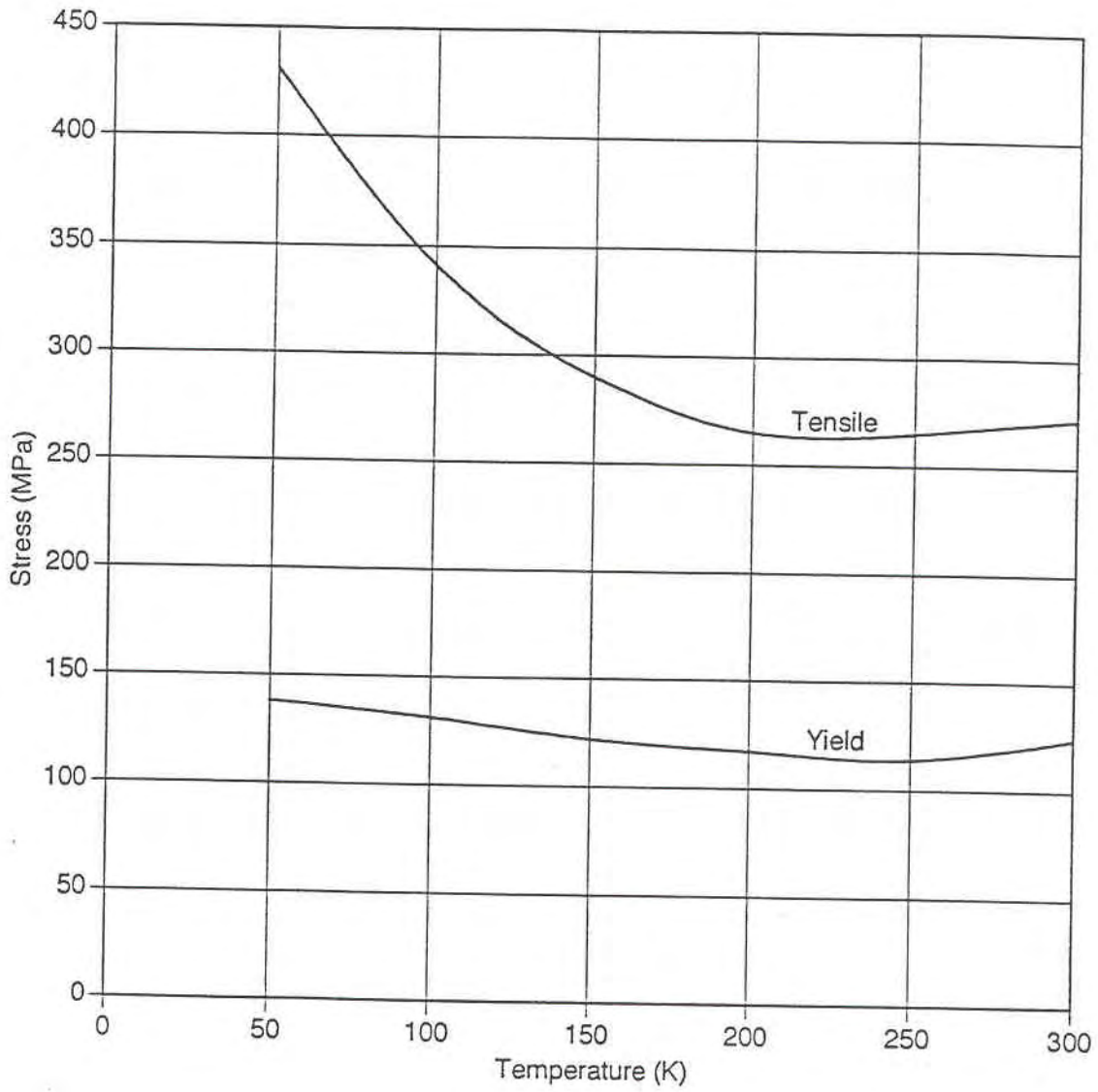

Figure A5.2
Yield and Tensile Stress of 5086 Aluminum as a Function of Temperature

Source:

McClintock, R. M., and H. P. Gibbons. *Mechanical Properties of Structural Materials at Low Temperatures, A Compilation from the Literature*. National Bureau of Standards, Monograph 13, United States Department of Commerce, Washington, DC (1960).

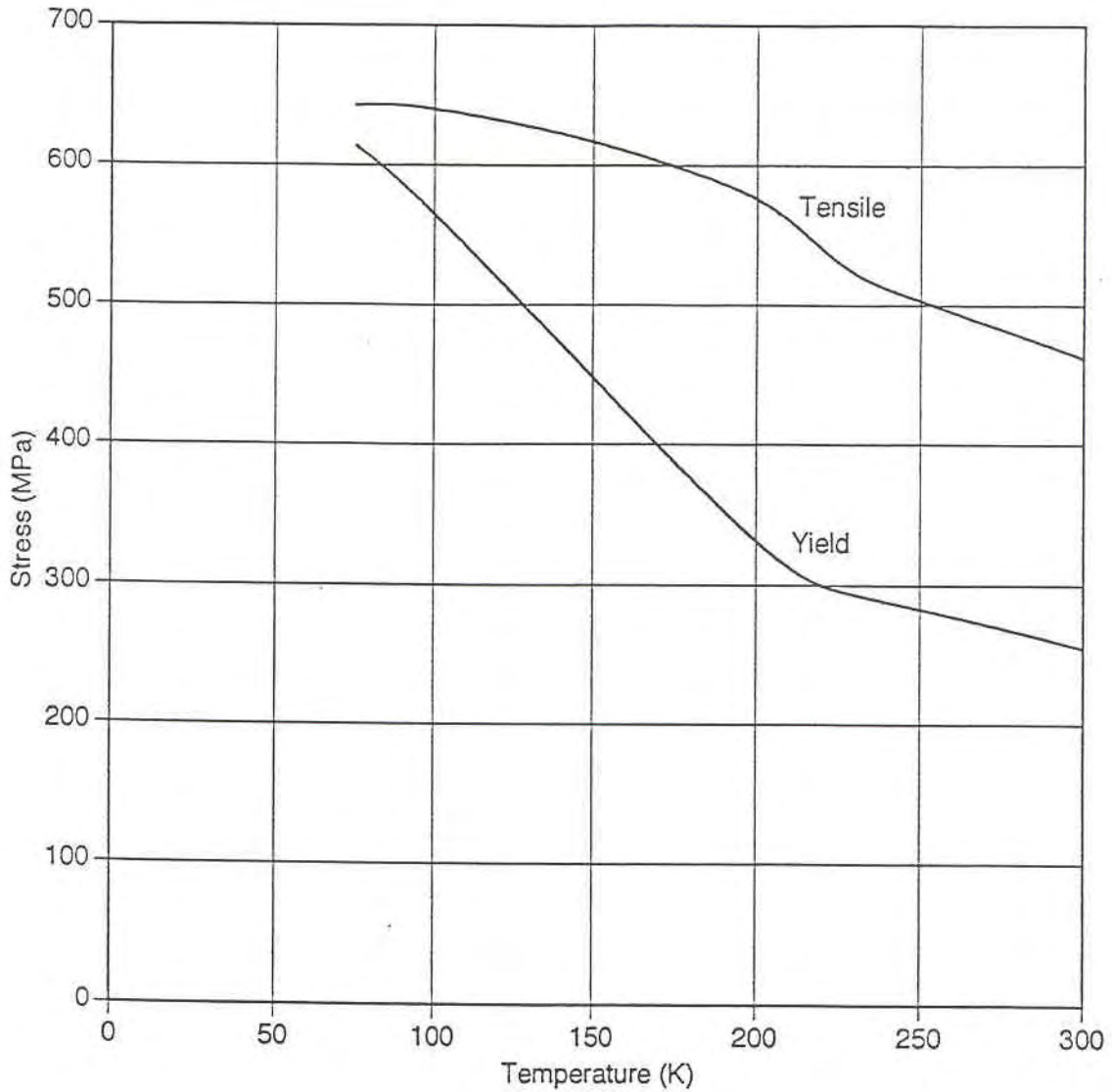

Figure A5.3

Yield and Tensile Stress of AISI 430 Stainless Steel as a Function of Temperature

Source:

McClintock, R. M., and H. P. Gibbons. *Mechanical Properties of Structural Materials at Low Temperatures, A Compilation from the Literature*. National Bureau of Standards, Monograph 13, United States Department of Commerce, Washington, DC (1960).

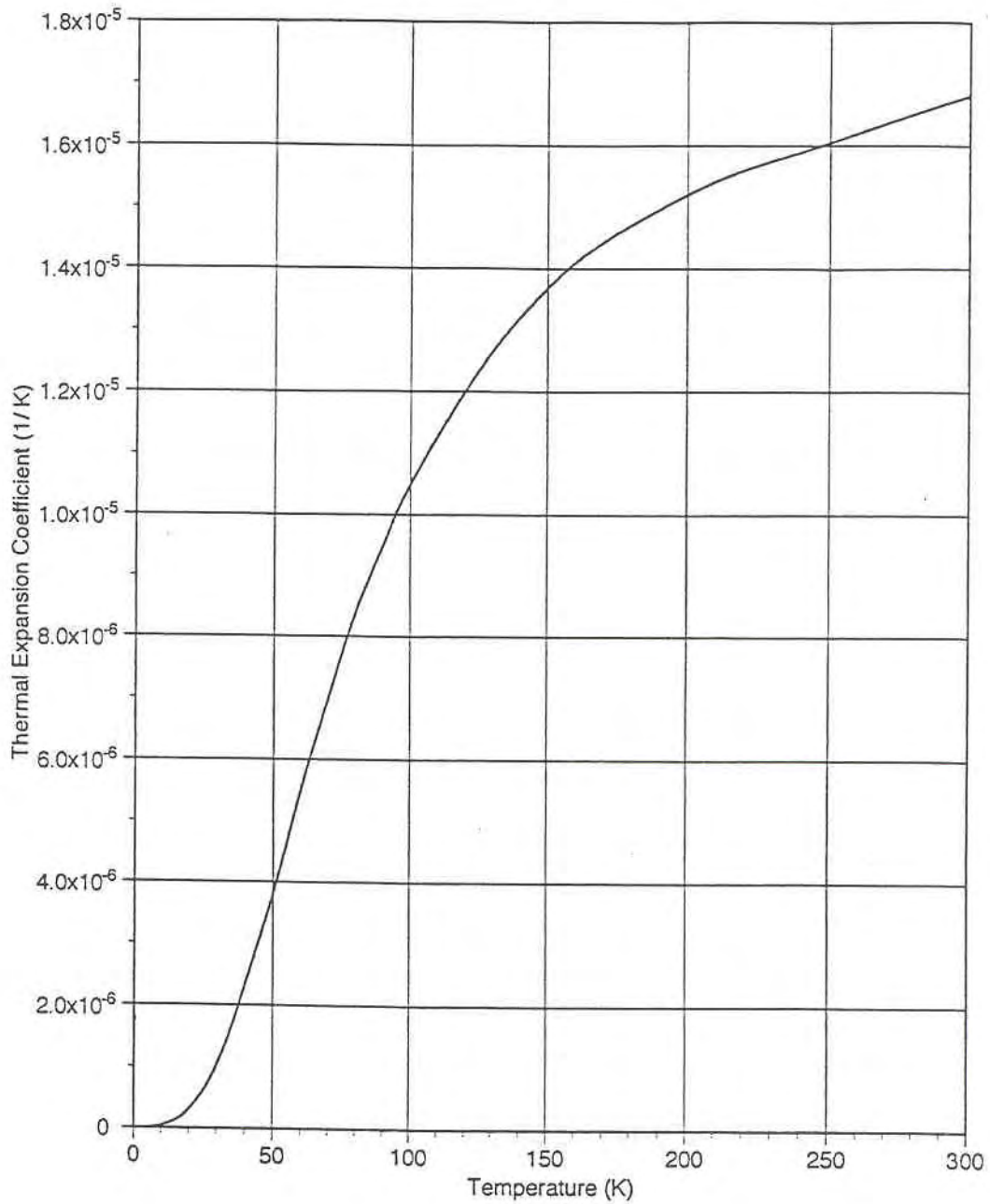
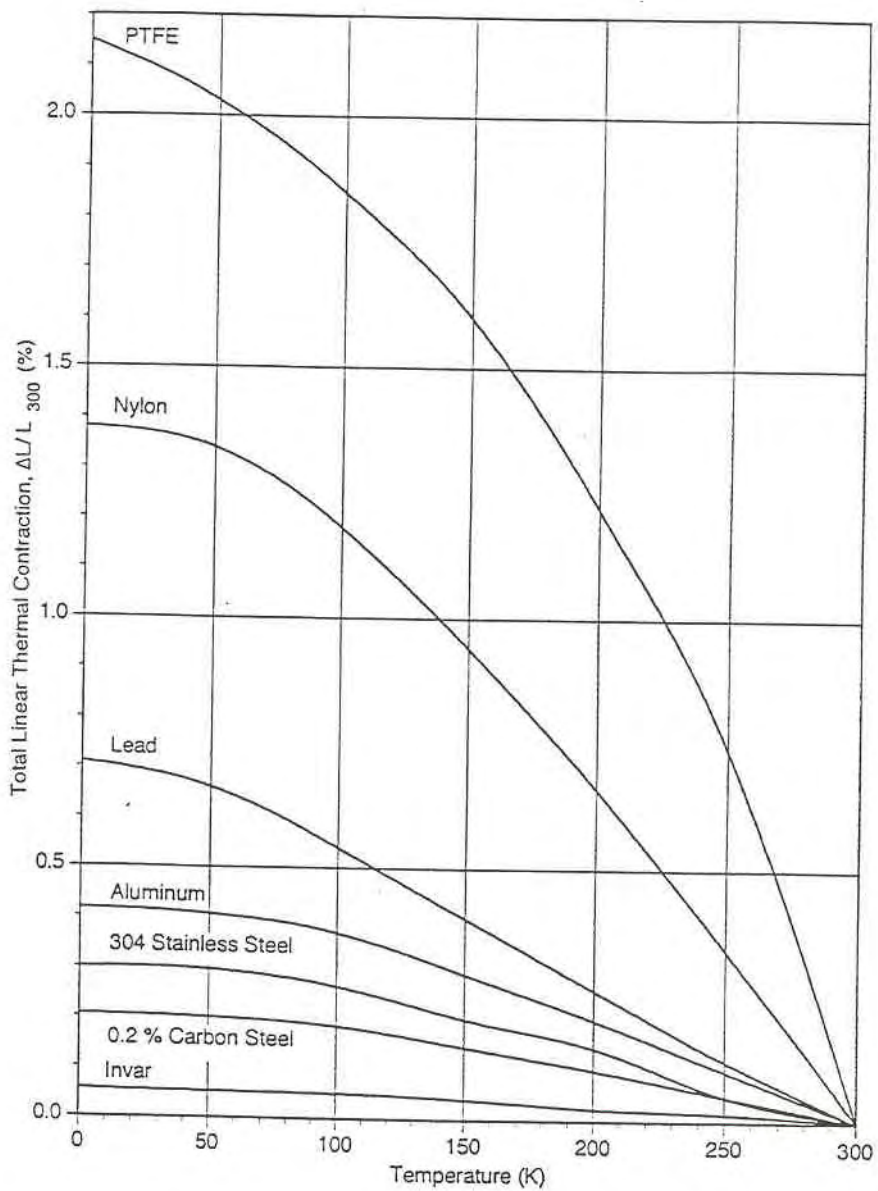

Figure A5.4
Thermal Expansion Coefficient of Copper as a Function of Temperature

Source:

Johnson, V. J., Ed.. *A Compendium of the Properties of Materials at Low Temperature (Phase I)*, WADD Technical Report 60-56, Part II, Properties of Solids, Office of Technical Services, United States Department of Commerce, Washington, DC (1960).



PTFE = Polytetrafluoroethylene (Teflon[®])

Figure A5.5

Total Linear Thermal Contraction as a Function of Temperature for Several Materials Showing the Total Contraction at a Given Temperature as the Temperature is Lowered from 300 K (80 °F) to that Temperature

Source:

Wigley, D. A. and P. Halford. "Materials of Construction and Techniques of Fabrication." *Cryogenic Fundamentals*, G. G. Haselden, Ed., chapter 6, Academic Press, London (1971).

Table A5.1
Summary of Material Compatibility for Hydrogen Service

Material	Service			Remarks
	GH ₂	LH ₂	SLH ₂	
Aluminum and its alloys	Yes	Yes	Yes	
Austenitic stainless steels with > 7% nickel (such as, 304, 304L, 308, 316, 321, 347)	Yes	Yes	Yes	Some make martensitic conversion if stressed above yield point at low temperature.
Carbon steels	Yes	No	No	Too brittle for cryogenic service.
Copper and its alloys (such as, brass, bronze, and copper-nickel)	Yes	Yes	Yes	
Gray, ductile, or cast iron	No	No	No	Not permitted for hydrogen service.
Low-alloy steels	Yes	No	No	Too brittle for cryogenic service.
Nickel and its alloys (such as, Inconel [®] and Monel [®])	No	Yes	Yes	Susceptible to hydrogen embrittlement
Nickel steels (such as, 2.25, 3.5, 5, and 9 % Ni)	No	No	No	Ductility lost at LH ₂ and SLH ₂ temperatures.
Titanium and its alloys	Yes	Yes	Yes	
Asbestos impregnated with Teflon [®]	Yes	Yes	Yes	Avoid use because of carcinogenic hazard.
Chloroprene rubber (Neoprene [®])	Yes	No	No	Too brittle for cryogenic service.
Dacron [®]	Yes	No	No	Too brittle for cryogenic service.
Fluorocarbon rubber (Viton [®])	Yes	No	No	Too brittle for cryogenic service.
Mylar [®]	Yes	No	No	Too brittle for cryogenic service.
Nitrile (Buna-N [®])	Yes	No	No	Too brittle for cryogenic service.
Polyamides (Nylon [®])	Yes	No	No	Too brittle for cryogenic service.
Polychlorotrifluorethylene (Kel-F [®])	Yes	Yes	Yes	
Polytetrafluorethylene (Teflon [®])	Yes	Yes	Yes	

Table A5.2
A Selection of Recommended Materials for Typical Applications^a

Application	Typical materials	
	LH ₂ or SLH ₂	GH ₂
Valves	Forged, machined, and cast valve bodies (304 or 316 stainless steel, or brass) with extended bonnet, and with other materials inside	Appropriate industrial products ^b
Fittings	Stainless steel bayonet type for vacuum jackets	Appropriate industrial products ^b
O-rings	Stainless steel ^c , Kel-F [®] , or Teflon [®]	Appropriate industrial products ^b
Gaskets	Soft Aluminum, lead, or annealed copper between serrated flanges; Kel-F [®] ; Teflon [®] ; glass-filled Teflon [®]	Appropriate industrial products ^b
Flexible hoses	Convolute vacuum jacketed 316 or 321 stainless steel	Stainless steel braided with Teflon-lining
Rupture disk assembly	304, 304L, 316, or 316L stainless steel	304, 304L, 316, or 316L stainless steel
Piping	304, 304L, 316, or 316L stainless steel	300 series stainless steel (316 preferred ^h) Carbon steel ^g
Dewars	304, 304L, 316, or 316L stainless steel	Not applicable
Lubricants	No lubricants used in some applications. ^h Lubricants listed for GH ₂ are compatible but will become solid at low temperatures. Dry lubricants, such as PTFE, PTFE carbon, PTFE bronze, fiberglass-PTFE graphite. ^e Graphite and molybdenum disulfide permit only very limited service life for bearings. ^f	Dupont Krytox 240AC, Fluoramics OXY-8, Dow Corning DC-33, Dow Corning FS-3452, Bray Oil Braycote 601, General Electric Versilube, Houghton Cosmolube 5100, Braycote 640 AC, Dupont GPL 206, Halocarbon Series 6.3 oil, and Kel-F [®] oil

^a Adapted from Table 6.1, Recommended Materials for Hydrogen Systems, in "Hydrogen Propellant," Chapter 6 in *Lewis Safety Manual*, NASA Technical Memorandum 104438, November (1992): pp. 6-70.

^b A number of standard industrial products are available covering a wide range of temperatures and pressures in a variety of compatible materials.

^c Metal O-rings have proven satisfactory when coated with a soft material and when used on smooth surfaces. Type 321 stainless steel, with a coating of teflon or silver, should be used in stainless steel flanges with stainless bolting. Teflon[®] coated aluminum should be used in aluminum flanges with aluminum bolting. Using similar materials avoids the leakage possibility from unequal contraction of dissimilar metals. (*Lewis Hydrogen Safety Manual*, December 10, (1959) pp. 3-18)

^d Threaded joints should be avoided in LH₂ or SLH₂ systems. If they must be used, the male and female threads should be tinned with a 60% lead-40% tin solder, then heated to provide a soldered joint with pipe thread strength. (*Lewis Hydrogen Safety Manual*, December 10, (1959) pp. 3-15)

^e W. Peschka, *Liquid Hydrogen, Fuel of the Future*, Springer-Verlag Wien, New York, (1992): pp. 197.

^f D. A. Wigley, "The Properties of Nonmetals," In *Mechanical Properties of Materials at Low Temperature*, Chapter 4, pp. 225, Plenum Press, New York 1971

^g Carbon steel meeting ANSI/ASME B31.3 standards may be used for GH₂ service above 244 K (-20 °F.) (*Lewis Safety Manual*, Chapter 6 "Hydrogen Propellant," NASA Technical Memorandum 104438, November (1992): pp. 6-35.)

^h McPherson, B., Private communication (1996).

Table A5.3
Minimum Temperatures and Basic Allowable Stresses in Tension for Selected Metals^a

Metal and/or Alloy ^b	Metal Form ^c	Minimum Temperature ^d [K (°F)]	Specified Minimum Tensile Strength [MPa (ksi)]	Specified Minimum Yield Strength [MPa (ksi)]	Basic Allowable Stress ^e [MPa (ksi)]
Aluminum Alloy					
WP1100-0, B361	forging & fitting	4.2 (-452)	75.8 (11)	20.7 (3)	13.8 (2.0)
1100-0, B241	pipe & tube	4.2 (-452)	75.8 (11)	20.7 (3)	13.8 (2.0)
3003-0, B241	pipe & tube	4.2 (-452)	96.5 (14)	34.5 (5)	22.8 (3.3)
5083-0, B209	plate & sheet	4.2 (-452)	275.8 (40)	124.1 (18)	82.7 (12.0)
5083-0, B241	pipe & tube	4.2 (-452)	268.9 (39)	110.3 (16)	73.8 (10.7)
WP6061-T6, B361	forging & fitting	4.2 (-452)	262.0 (38)	241.3 (35)	87.6 (12.7)
6061-T6, B241	pipe & tube	4.2 (-452)	262.0 (38)	241.3 (35)	87.6 (12.7)
Copper & Copper Alloy					
Cu Forging, B283	forging	4.2 (-452)	227.5 (33)	75.8 (11)	50.3 (6.7)
Cu Plate, B152	plate & sheet	4.2 (-452)	206.8 (30)	68.9 (10)	46.2 (5.8)
Cu Pipe, B42, annealed	pipe & tube	4.2 (-452)	206.8 (30)	62.1 (9)	41.4 (6.0)
Red brass pipe	pipe & tube	4.2 (-452)	275.8 (40)	82.7 (12)	55.2 (8.0)
90Cu-10Ni, B171	plate & sheet	4.2 (-452)	275.8 (40)	103.4 (15)	68.9 (10.0)
90Cu-10Ni, B466	pipe & tube	4.2 (-452)	262.0 (38)	89.6 (13)	60.0 (8.4)
70Cu-30Ni, B171	plate & sheet	4.2 (-452)	482.6 (70)	206.8 (30)	137.9 (20.0)
70Cu-30Ni, B466	pipe & tube	4.2 (-452)	344.7 (50)	124.1 (18)	82.7 (12.0)
Nickel & Nickel Alloy					
Ni, B366	forging & fitting	74.8 (-325)	379.2 (55)	82.7 (12)	55.2 (8.0)
Ni, B162	plate & sheet	74.8 (-325)	379.2 (55)	103.4 (15)	68.9 (10.0)
Ni, B161	pipe & tube	74.8 (-325)	379.2 (55)	103.4 (15)	68.9 (10.0)
Ni-Cu, B564	forging & fitting	74.8 (-325)	482.6 (70)	172.4 (25)	115.1 (16.7)
Ni-Cu, B127	plate & sheet	74.8 (-325)	482.6 (70)	193.1 (28)	128.9 (18.7)
Ni-Cu, B165	pipe & tube	74.8 (-325)	482.6 (70)	193.1 (28)	128.9 (18.7)
Ni-Cr-Fe, B564	forging & fitting	74.8 (-325)	551.6 (80)	241.3 (35)	160.6 (23.3)
Ni-Cr-Fe, B168	plate & sheet	74.8 (-325)	551.6 (80)	241.3 (35)	160.6 (23.3)
Ni-Cr-Fe, B167	pipe & tube	74.8 (-325)	551.6 (80)	206.8 (30)	137.9 (20.0)
Steel, Carbon					
A285 Grade C,	plate & sheet	---- ^f	379.2 (55)	206.8 (30)	126.2 (18.3)
A285 Grade C, A524	pipe & tube	244 (-20)	379.2 (55)	206.8 (30)	126.2 (18.3)
A442 Grade 50, A672	pipe & tube	---- ^f	413.7 (60)	220.6 (32)	137.9 (20.0)
Steel, Low & Intermediate Alloy					
3.5 Ni, A420	forging & fitting	172 (-150)	448.2 (65)	241.3 (35)	149.6 (21.7)
3.5 Ni, A203	plate	244 (-20)	448.2 (65)	255.1 (37)	149.6 (21.7)
3.5 Ni, A333	pipe & tube	172 (-150)	448.2 (65)	241.3 (35)	149.6 (21.7)
5 Ni, A645	plate	103 (-275)	655.0 (95)	448.2 (65)	218.6 (31.7)
9 Ni, A420	forging & fitting	77 (-320)	758.4 (110)	517.1 (75)	218.6 (31.7)
9 Ni, A353	plate	77 (-320)	689.5 (100)	517.1 (75)	218.6 (31.7)
9 Ni, A333	pipe & tube	77 (-320)	689.5 (100)	517.1 (75)	218.6 (31.7)

Table A5.3 (continued)
Minimum Temperatures and Basic Allowable Stresses in Tension for Selected Metals^a

Metal and/or Alloy ^b	Metal Form ^c	Minimum Temperature ^d [K (°F)]	Specified Minimum Tensile Strength [MPa (ksi)]	Specified Minimum Yield Strength [MPa (ksi)]	Basic Allowable Stress ^e [MPa (ksi)]
Steel, Stainless, Ferritic					
405 (12Cr-Al), A240	plate & sheet	244 (-20)	413.7 (60)	172.4 (25)	115.1 (16.7)
430 (17Cr), A240	plate & sheet	244 (-20)	448.2 (65)	206.8 (30)	137.9 (18.4)
Steel, Stainless, Martensitic					
410 (13Cr), A240	plate & sheet	244 (-20)	448.2 (65)	206.8 (30)	126.9 (18.4)
Steel, Stainless, Austenitic					
304 (18Cr-8Ni)	plate & sheet	19.3 (-425)	517.1 (75)	206.8 (30)	137.9 (20.0)
304	pipe & tube	19.3 (-425)	517.1 (75)	206.8 (30)	137.9 (20.0)
F304 (18Cr-8Ni)	forging & fitting	19.3 (-425)	517.1 (75)	206.8 (30)	137.9 (20.0)
304L (18Cr-8Ni)	plate & sheet	19.3 (-425)	482.6 (70)	172.4 (25)	115.1 (16.7)
304L	pipe & tube	19.3 (-425)	482.6 (70)	172.4 (25)	115.1 (16.7)
F304L (18Cr-8Ni)	forging & fitting	19.3 (-425)	482.6 (70)	172.4 (25)	115.1 (16.7)
310 (25Cr-20Ni)	plate & sheet	74.8 (-325)	517.1 (75)	206.8 (30)	137.9 (20.0)
F310 (25Cr-20Ni)	forging & fitting	74.8 (-325)	517.1 (75)	206.8 (30)	137.9 (20.0)
310S (25Cr-20Ni)	plate & sheet	74.8 (-325)	517.1 (75)	206.8 (30)	137.9 (20.0)
310S	pipe & tube	74.8 (-325)	517.1 (75)	206.8 (30)	137.9 (20.0)
316 (16Cr-12Ni-2Mo)	plate & sheet	19.3 (-425)	517.1 (75)	206.8 (30)	137.9 (20.0)
316	pipe & tube	19.3 (-425)	517.1 (75)	206.8 (30)	137.9 (20.0)
F316 (16Cr-12Ni-2Mo)	forging & fitting	74.8 (-325)	517.1 (75)	206.8 (30)	137.9 (20.0)
316L (16Cr-12Ni-2Mo)	plate & sheet	19.3 (-425)	482.6 (70)	172.4 (25)	115.1 (16.7)
316L	pipe & tube	74.8 (-325)	482.6 (70)	172.4 (25)	115.1 (16.7)
F316L (16Cr-12Ni-2Mo)	forging & fitting	19.3 (-425)	482.6 (70)	172.4 (25)	115.1 (16.7)
321 (18Cr-10Ni-Ti)	plate & sheet	74.8 (-325)	517.1 (75)	206.8 (30)	137.9 (20.0)
321 (18Cr-10Ni-Ti)	pipe & tube	74.8 (-325)	517.1 (75)	206.8 (30)	137.9 (20.0)
F321 (18Cr-10Ni-Ti)	forging & fitting	74.8 (-325)	517.1 (75)	206.8 (30)	137.9 (20.0)
347 (18Cr-10Ni-Cb)	plate & sheet	19.3 (-425)	517.1 (75)	206.8 (30)	137.9 (20.0)
347	pipe & tube	19.3 (-425)	517.1 (75)	206.8 (30)	137.9 (20.0)
F347 (18Cr-10Ni-Cb)	forging & fitting	19.3 (-425)	517.1 (75)	206.8 (30)	137.9 (20.0)
Titanium & Titanium Alloy					
Ti, B337	pipe & tube	214 (-75)	241.3 (35)	172.4 (25)	80.7 (11.7)
Ti-0.2Pd, B337	pipe & tube	214 (-75)	344.7 (50)	275.8 (40)	115.1 (16.7)

^a ASME B31.3-1996 Edition

^b ASME B31.3 should be consulted regarding grade and specifications for this material.

^c ASME B31.3 should be consulted for special notes regarding restrictions on this material.

^d The minimum temperature shown is that design minimum temperature for which the material is normally suitable without impact testing other than that required by the material specification. However, the use of a material at a design minimum temperature below 244 K (-20 °F) is established by rules in ASME B31.3, including any necessary impact test requirements.

^e Basic allowable stress in tension for the temperature range from the minimum temperature to 311 K (100 °F)

^f ASME B31.3 should be consulted regarding the minimum temperature for this material.

Table A5.4
Elastic Properties of Selected Materials at Room Temperature
and Liquid Hydrogen Temperature

Material	Temperature (K)	Young's Modulus (GPa)	Shear Modulus (GPa)	Bulk Modulus (GPa)	Poisson's Ratio
Aluminum Alloys					
3003	300	TBA ^d	TBA	TBA	TBA
	20	TBA	TBA	TBA	TBA
5083-0	300	71.6a	26.82 ^a	71.56 ^a	0.3334 ^a
	20	80.8a	30.68 ^a	74.23 ^a	0.3184 ^a
6061-T6	300	70.2a	26.36 ^a	72.14 ^a	0.3383 ^a
	20	77.7a	29.22 ^a	74.8 ^a	0.3269 ^a
Invar [®]	300	152.5 ^a	55.8 ^a	110.9 ^a	0.2843 ^a
	20	141.5 ^a	50.5 ^a	124.1 ^a	0.3183 ^a
Stainless Steels					
304	300	189.8 ^a	73.5 ^a	150.7 ^a	0.2901 ^a
	20	204.5 ^a	80.4 ^a	148.8 ^a	0.2714 ^a
304L	300	TBA	TBA	TBA	TBA
	20	TBA	TBA	TBA	TBA
310	300	183.7 ^a	70.2 ^a	159.2 ^a	0.3074 ^a
	20	198.8 ^a	76.7 ^a	162.3 ^a	0.2958 ^a
316	300	203.8 ^a	78.5 ^a	167.7 ^a	0.2972 ^a
	20	220.6 ^a	86.0 ^a	168.4 ^a	0.2819 ^a
Fluorocarbon Resins					
Polytetrafluorethylene (Teflon [®]) (PTFE or TFE)	300	0.55 ^{b,c}	TBA	TBA	TBA
	20	4.27 ^{b,c}	TBA	TBA	TBA
Polytetrafluorethylene copolymer hexafluoropropylene (FEP)	300	0.48 ^{b,c}	TBA	TBA	TBA
	20	5.03 ^{b,c}	TBA	TBA	TBA

^a *LNG Materials and Fluids: A User's Manual of Property Data in Graphic Format*, D. Mann, Ed., National Bureau of Standards, Boulder, CO (1977).

^b Unfilled resin

^c *Properties of Teflon[®] at Cryogenic Temperatures*, E. I. du Pont de Nemours and Co., Wilmington, DE (1976).

^d To be added

Table A5.5
Mechanical Properties of Selected Materials at Room Temperature
and Liquid Hydrogen Temperature

Material	Temperature (K)	Yield Strength (MPa)	Tensile Strength (MPa)	Fatigue Strength ^a (MPa)
Aluminum Alloys				
3003-0	300	40 ^c	110 ^c	TBA ^f
	20	69 ^c	375 ^c	TBA
5083-0	300	141 ^c	310 ^c	235 ^c
	20	170 ^c	520 ^c	283 ^{b,c}
6061-T6	300	278 ^c	310 ^c	200
	20	350 ^c	498 ^c	383
Invar [®]	300	280 ^c	510 ^c	TBA
	20	800 ^c	1040 ^c	TBA
Stainless Steels				
304	300	520 ^c	640 ^c	190 ^c
	20	900 ^c	1730 ^c	TBA
304L	300	280 ^c	600 ^c	210 ^c
	20	330 ^c	1730 ^c	210 ^{b,c}
310	300	220 ^c	550 ^c	280 ^c
	20	680 ^c	1260 ^c	520 ^{b,c}
316	300	230 ^c	570 ^c	TBA
	20	610 ^c	1400 ^c	TBA
Fluorocarbon Resins				
Polytetrafluorethylene (Teflon [®]) (PTFE or TFE)	300	11.7 ^{d,e}	31.0 ^{d,e}	TBA
	20	122.7 ^{d,e}	123.4 ^{d,e}	TBA
Polytetrafluorethylene copolymer Hexafluoropropylene (FEP)	300	13.8 ^{d,e}	27.6 ^{d,e}	TBA
	20	163.4 ^{d,e}	164.1 ^{d,e}	TBA
^a	Axial fatigue strength at 106 cycles			
^b	At 77 K, not 20 K			
^c	<i>LNG Materials and Fluids: A User's Manual of Property Data in Graphic Format</i> , D. Mann, Ed., National Bureau of Standards, Boulder, Colorado (1977).			
^d	Unfilled resin			
^e	<i>Properties of Teflon[®] at Cryogenic Temperatures</i> , E. I. du Pont de Nemours and Co., Wilmington, DE (1976).			
^f	To be added			

Table A5.6
Thermal Properties of Selected Materials at Room
Temperature and Liquid Hydrogen Temperature

Material	Temperature (K)	Thermal Conductivity [W/(m·K)]	Specific Heat [J/(kg K)]	Instantaneous Thermal Expansion ^a	Linear Thermal Expansion ^b
Aluminum Alloys					
3003	300	175 ^d	902 ^{d,f}	23.2x10 ⁻⁶ ^{d,f}	+ 16x10 ⁻⁵ ^{d,f}
	20	58 ^d	8.9 ^{d,f}	0.2x10 ⁻⁶ ^{d,f}	-415x10 ⁻⁵ ^{d,f}
5083	300	118 ^d	902 ^{d,f}	23.2x10 ⁻⁶ ^{d,f}	+ 16x10 ⁻⁵ ^{d,f}
	20	17.2 ^d	8.9 ^{d,f}	0.2x10 ⁻⁶ ^{d,f}	-415x10 ⁻⁵ ^{d,f}
6061	300	NA	902 ^{d,f}	23.2x10 ⁻⁶ ^{d,f}	+ 16x10 ⁻⁵ ^{d,f}
	20	NA	8.9 ^{d,f}	0.2x10 ⁻⁶ ^{d,f}	-415x10 ⁻⁵ ^{d,f}
Invar [®]	300	14 ^d	NA	1.2x10 ⁻⁶ ^d	0 ^d
	20	1.65 ^d	11.8 ^d	0 ^d	-40x10 ⁻⁵ ^d
Stainless Steels					
304	300	14.7 ^d	NA	15.9x10 ⁻⁶ ^d	+ 12x10 ⁻⁵ ^d
	20	2.12 ^d	12.7 ^d	0.7x10 ⁻⁶ ^d	-298x10 ⁻⁵ ^d
304L	300	14.7 ^d	NA	15.9x10 ⁻⁶ ^d	+ 12x10 ⁻⁵ ^d
	20	2.12 ^d	11.8 ^d	0.5x10 ⁻⁶ ^d	-298x10 ⁻⁵ ^d
310	300	11.5 ^d	475 ^d	15.9x10 ⁻⁶ ^d	+ 12x10 ⁻⁵ ^d
	20	1.71 ^d	11.6 ^d	0.5x10 ⁻⁶ ^d	-298x10 ⁻⁵ ^d
316	300	14.7 ^d	480 ^d	15.9x10 ⁻⁶ ^d	+ 12x10 ⁻⁵ ^d
	20	2.12 ^d	13.7 ^d	0.5x10 ⁻⁶ ^d	-298x10 ⁻⁵ ^d
Fluorocarbon Resins					
Polytetrafluorethylene (Teflon [®]) (PTFE or TFE)	300	0.25 ^h	1,010 ^{c,f}	1.5x10 ^{-4e,g}	0 ⁱ
	20	0.13 ^h	76 ^f	NA	-2,150x10 ⁻⁵ ⁱ
Polytetrafluorethylene copolymer hexafluoropropylene (FEP)	300	0.20 ^h	1,088 ^h	TBA ^j	0 ⁱ
	20	0.12 ^h	TBA	TBA	-1,800x10 ⁻⁵ ⁱ

^a Instantaneous Thermal Expansion = [(1/L)(dL/dT)], with units of "1/K"

^b Linear Thermal Expansion = [(L - L₂₉₃)/L₂₉₃], with units of "m/m"

^c At 280 K, not 300 K

^d *LNG Materials and Fluids: A User's Manual of Property Data in Graphic Format.*, D. Mann, Ed., National Bureau of Standards, Boulder, Colorado (1977).

^e at 295 K, not 300 K

^f *A Compendium of the Properties of Materials at Low Temperature (Phase I), Part II: Properties of Solids.*, V. J. Johnson, Ed., WADD Technical Report 60-56, October (1960).

^g Reed, R. P., R. E. Schramm, and A. F. Clark. *Mechanical, Thermal, and Electrical Properties of Selected Polymers, Cryogenics.* February (1973): pp. 67-82.

^h Teflon[®], Cadillac Plastic and Chemical Co., Birmingham, MI, 1980.

ⁱ Schwartzberg, F. R., S. H. Osgood, and R. G. Herzog. *Cryogenic Materials Data Handbook.* Air Force Materials Laboratory, AFML-TDR-64-280, Supplement 4, Vol. II. Wright-Patterson AFB, OH, August (1968).

^j To be added

Table A5.7
Typical Characteristics of Hydrogen Embrittlement Types ^a

Characteristic	Environmental Hydrogen Embrittlement	Internal Hydrogen Embrittlement	Hydrogen Reaction Embrittlement
Usual source of hydrogen	Gaseous hydrogen	Processing, electrolysis, corrosion	Gaseous or atomic hydrogen from any source.
Typical conditions	10 ⁻⁶ to 10 ⁻⁸ Pa H ₂ gas pressure. Most severe near room temperature. Observed from -100 to 700 °C. Gas purity and strain rate important.	0.1 to 10 ppm average H ₂ content. Most severe near room temperature. Observed from -100 to 100 °C. Strain rate is important.	Heat treatment or service in H ₂ , especially at elevated temperatures.
Test methods for embrittlement	Notched tensile; unnotched tensile, creep rupture; fatigue (low, high cycle); fracture toughness; disk pressure test.	Notched tensile delayed failure; slow strain rate tensile; bend tests; C-rings; torqued bolts.	Visual or metallographic observation.
Location of crack initiation	On surface or internal. ^b	Internal crack initiation; incubation (reversible); slow discontinuous growth; and fast fracture.	Usually internal initiation from bubbles or flakes.
Rate-controlling embrittlement step	Adsorption is transfer step; absorption or lattice diffusion ^b is embrittling step.	Lattice diffusion to internal stress risers.	Chemical reaction to form hydrides or gas bubbles.

^a Gray H. R, "Testing for Hydrogen Environment Embrittlement: Experimental Variables," *Hydrogen Embrittlement Testing*, American Society for Testing and Materials, Special Technical Publication, ASTM STP-543, Philadelphia, PA (1974), pp. 133-151.

^b Unresolved

Table A5.8
Susceptibility of Materials to Embrittlement in Hydrogen at 10,000 psi and 72 °F^a

Material	Strength ratio, H ₂ /He		Unnotched ductility			
	Notched ^b	Unnotched ^d	Elongation, %		Reduction of Area, %	
			He	H ₂	He	H ₂
Extremely embrittled						
18Ni-250 Maraging Steel	0.12	0.68	8.2	0.2	55	2.5
410 Stainless Steel	.22	.70	15	1.3	60	12
1042 Steel (quenched and tempered)	.22	----	----	----	----	----
17-7 pH Stainless Steel	.23	.92	17	1.7	45	2.5
Fe-9Ni-4Co-0.20C	.24	.86	15	.5	67	15
H-11	.25	.57	8.8	0	30	0
René 41	.27	.84	21	4.3	29	11
Electro-Formed Nickel	.31	----	----	----	----	----
4140	.40	.96	14	2.6	48	9
Inconel 718	.46	.93	17	1.5	26	1
440C	.50	.40	----	----	3.2	0
Severely embrittled						
Ti-6Al-4V (STA)	0.58	----	----	----	----	----
430F	.68	----	22	14	64	37
Nickel 270	.70	----	56	52	89	67
A515	.73	----	42	29	67	35
HY-100	.73	----	20	18	76	63
A372 (class IV)	.74	----	20	10	53	18
1042 (normalized)	.75	----	----	----	59	27
A533-B	.78	----	----	----	66	33
Ti-6Al-4V (annealed)	.79	----	----	----	----	----
AISI 1020	.79	----	----	----	68	45
HY-50	.80	----	----	----	70	60
Ti-5Al-2.5Sn (ELI)	.81	----	----	----	45	39
Armco Iron	.86	----	----	----	83	50
Slightly embrittled						
304 ELC Stainless Steel	0.87	----	----	----	78	71
305 Stainless Steel	0.89	----	----	----	78	75
Be-Cu Alloy 25	0.93	----	----	----	72	71
Titanium	0.95	----	----	----	61	61
Negligibly embrittled						
310 Stainless Steel	0.93	----	----	----	64	62
A286	.97	----	----	----	44	43
7075-T73 Aluminum Alloy	.98	----	----	----	37	35
316 Stainless Steel	1.00	----	----	----	72	75
OFHC Copper	1.00	----	----	----	94	94
NARloy-Z ^c	1.10	----	----	----	24	22
6061-T6 Aluminum Alloy	1.10	----	----	----	61	66
1100 aluminum	1.40	----	----	----	93	93

^a Chandler, W. T. and R. J. Walter. "Testing to Determine the Effect of High Pressure Hydrogen Environments on the Mechanical Properties of Metals," in *Hydrogen Embrittlement Testing*, ASTM

543, American Society for Testing and Materials, Philadelphia, PA (1974) pp. 170-197.

^b Stress concentration factor, K_t , = 8.4

^c Tested in 7000 psi (48.3 MPa) hydrogen

Note: Dashes indicate no information available

Table A5.9
Comparison of Air, Helium, and Hydrogen Exposure
on Selected Aluminum, Nickel, and Copper Alloys^{a-e}

Alloy	Test Environment	Test Pressure (psi)	Strength, psi		Ductility	
			Yield	Ultimate	Reduction in area (%)	Elongation (%)
Aluminum Alloys						
2011	Air	14.5	39.0x10 ³	49.1x10 ³	48	17
	He	10,000	32.9x10 ³	42.9x10 ³	57	18
	H ₂	10,000	31.9x10 ³	42.9x10 ³	58	17
2024	Air	14.5	51.9x10 ³	70.9x10 ³	33	15
	He	10,000	46.9x10 ³	63.9x10 ³	36	19
	H ₂	10,000	44.9x10 ³	61.9x10 ³	35	18
6061	Air	14.5	25.9x10 ³	33.9x10 ³	75	14
	He	10,000	28.9x10 ³	25.9x10 ³	82	15
	H ₂	10,000	20.0x10 ³	26.9x10 ³	82	14
6063	Air	14.5	31.0x10 ³	34.9x10 ³	62	13
	He	10,000	22.9x10 ³	27.9x10 ³	83	15
	H ₂	10,000	22.9x10 ³	29.0x10 ³	84	15
Nickel and Nickel Alloys						
Nickel	He	10,000	26.0x10 ³	61.9x10 ³	79	57
	H ₂	10,000	24.9x10 ³	62.9x10 ³	54	47
Inconel [®] 718	He	10,000	151x10 ³	186x10 ³	40	25
	H ₂	10,000	155x10 ³	186x10 ³	11	9
Inconel [®] 700	Air	14.7	152x10 ³	204x10 ³	45	21
	He	10,000	149x10 ³	195x10 ³	44	22
	H ₂	10,000	149x10 ³	177x10 ³	14	10
Hastelloy [®] X	Air	14.7	46.9 x10 ³	99.9x10 ³	69	56
	He	10,000	41.0 x10 ³	99.9x10 ³	68	59
	H ₂	10,000	41.9 x10 ³	94.9x10 ³	58	55
Copper Alloys						
OFHC	Air	14.7	13.9x10 ³	33.9x10 ³	71	44
	H ₂	10,000	13.9x10 ³	33.1x10 ³	71	45
70-30 brass	Air	14.7	17.9x10 ³	52.9x10 ³	70	59
	H ₂	10,000	14.9x10 ³	50.0x10 ³	84	58
Aluminum bronze	Air	14.7	32.5x10 ³	87.0x10 ³	67	48
	H ₂	10,000	30.7x10 ³	83.5x10 ³	71	49

^a Chandler, W. T. and R. J. Walter. "Hydrogen Environment Embrittlement of Metals and Its Control," *Hydrogen Energy*, Proceedings of the *Hydrogen Miami Energy Conference*, T. H. Veziroglu, Ed., Plenum Press, New York (1975): pp. 1057-1058.

^b Groenvald, T. D. and A. D. Elcea. "Hydrogen Stress Cracking in Natural Gas Transmission Pipelines," *Hydrogen in Metals*, I. M. Bernstein and A. W. Thompson, Eds., ASM (1974).

^c Robinson, S. L. *Hydrogen Compatibility of Structural Materials for Energy Storage and Transmission Applications*. Sandia National Laboratories, SAND77-8240, June (1977).

^d Hoover, W. R., et. al. *Hydrogen Compatibility of Structural Materials for Energy Storage and Transmission Applications*. Sandia National Laboratories, SAND80-8202, Livermore, CA, February (1980).

^e Stuhrke, W. F. and J. L. Carpenter. *Fracture Toughness and Testing Data - A Technology Survey*. NASA-CR-134752, January, (1975).

A.6 HYDROGEN AND HYDROGEN FIRE DETECTION

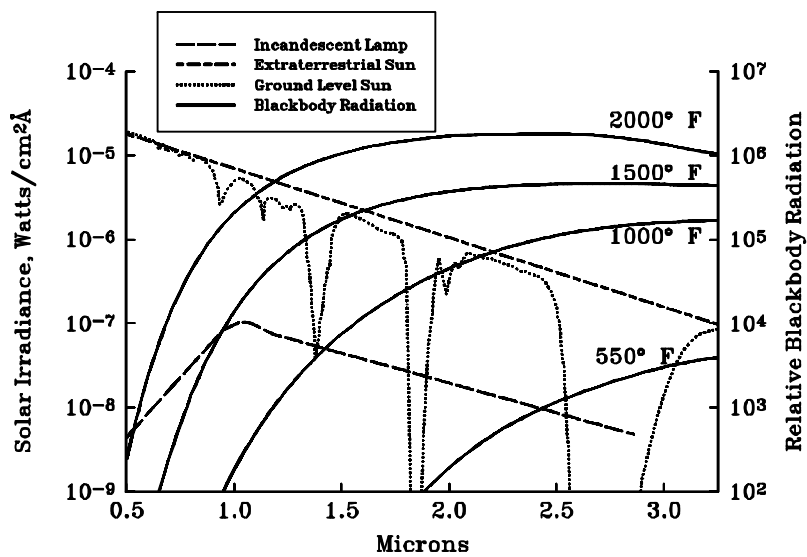

Figure A6.1
Irradiance of Common IR Sources

Source:

Rosen, B., V. H. Dayan, and R. L. Proffitt. "Hydrogen Leak and Fire Detection - A Survey." NASA SP-5092, Washington, DC (1970).

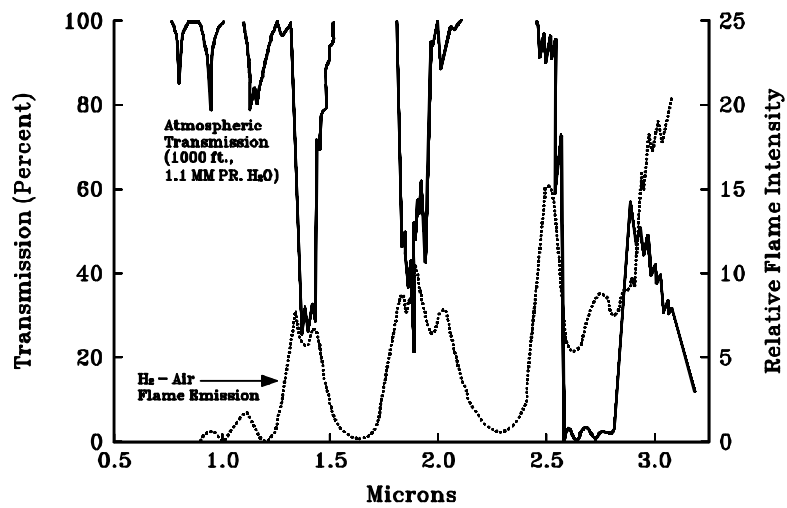

Figure A6.2
 Atmospheric IR Transmission and H₂-Air-Flame Emission

Source:

Rosen, B., V. H. Dayan, and R. L. Proffitt. "Hydrogen Leak and Fire Detection - A Survey." NASA SP-5092, Washington, DC (1970).

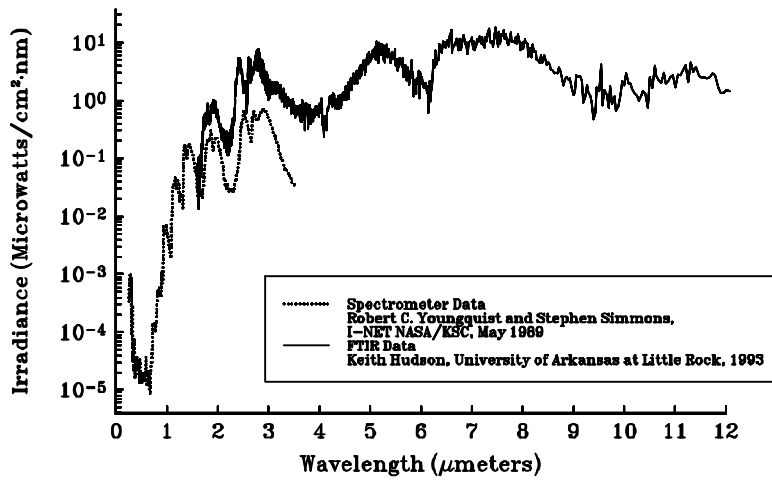

Figure A6.3
UV/VIS/Near-IR Emissions

Source:

Barnes, H.L. Private communication, NASA Stennis Space Center (1995).

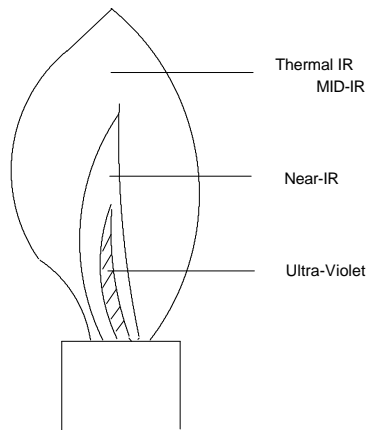

Figure A6.4
Flame Components

Note: A larger portion of the flame emits in the thermal infrared than in the ultra violet. This means that a fire looks bigger with a thermal imager that it does with a near-infrared imager.

Table A6.1
Typical Hydrogen Gas Detectors

Type of Detector	Description
Catalytic	A palladium and/or platinum catalyst is used to facilitate the combustion of hydrogen with oxygen. A sensing element detects the heat of combustion.
Electro chemical	Liquid or solid electrolytes surrounding a sensing electrode and a counter electrode. Reaction with hydrogen product produces a current. The hydrogen gas must flow through a gas permeable membrane to reach the electrolyte.
Semi conducting Oxide	Hydrogen gas reacts with chemisorbed oxygen in a semiconductor material, such as tin oxide, and changes the resistance of the material.
Thermal Conductivity	The rate of heat conduction from a heat source into the surrounding environment is dependent on the thermal conductivity of that environment.
Mass Spectrometer	The gas is ionized and then accelerated through an electric field along a curved path. The amount of curvature induced by the electric field is dependent on the mass of the particle and is used to separate the particles by mass. A detector is placed in the path of the desired gas to be measured.
Sonic	Leaking gas can produce acoustical emissions in the range of 30 to 100 kHz, with 40 kHz being the most common.
Optical	The differences in the refractive index of various gases can be used for detection in sensors using optical interferometry.
Glow Plugs	Glow plugs are not a true gas detection technique. When a combustible gas mixture exists, the glow plug ignites the mixture and then the fire is detected with heat sensors.

Table A6.2
A Survey and Analysis of Commercially Available Hydrogen Sensors

Conditions	Catalytic Combustion Sensors (CC)			Electro chemical Sensors (BC)			Semi conducting Oxide Sensors (SO)			Thermal Conductivity Detectors (TC)		
	D	RT	PR	D	RT	PR	D	RT	PR	D	RT	PR
In Air												
293 K/200 ppm	+	0	-	+	+	+	+	+	+	+	0	+
293 K/2% H ₂	+	0	-	+	+	+	+	+	+	+	0	+
293 K/100% H ₂	-	-	-	+	+	+	+	+	+	+	0	+
77 K/200 ppm	+	?	-	-	-	-	+	?	?	+	?	?
77 K/2% H ₂	+	?	-	-	-	-	+	?	?	+	?	?
77 K/100% H ₂	-	-	-	-	-	-	+	?	?	+	?	?
In Helium												
293 K/200 ppm	-	-	-	+	+	+	-	-	-	-	-	-
293 K/2% H ₂	-	-	-	+	+	+	-	-	-	-	-	-
293 K/100% H ₂	-	-	-	+	+	+	-	-	-	-	-	-
77 K/200 ppm	-	-	-	-	-	-	-	-	-	-	-	-
77 K/2% H ₂	-	-	-	-	-	-	-	-	-	-	-	-
77 K/100% H ₂	-	-	-	-	-	-	-	-	-	-	-	-
In Nitrogen												
293 K/200 ppm	-	-	-	+	+	+	-	-	-	+	0	+
293 K/2% H ₂	-	-	-	+	+	+	-	-	-	+	0	+
293 K/100% H ₂	-	-	-	+	+	+	-	-	-	+	0	+
77 K/200 ppm	-	-	-	-	-	-	-	-	-	+	?	?
77 K/2% H ₂	-	-	-	-	-	-	-	-	-	+	?	?
77 K/100% H ₂	-	-	-	-	-	-	-	-	-	+	?	?
In Vacuum												
293 K/200 ppm	-	-	-	-	-	-	-	-	-	+	0	+
293 K/2% H ₂	-	-	-	-	-	-	-	-	-	+	0	+
293 K/100% H ₂	-	-	-	-	-	-	-	-	-	+	0	+
77 K/200 ppm	-	-	-	-	-	-	-	-	-	+	?	?
77 K/2% H ₂	-	-	-	-	-	-	-	-	-	+	?	?
77 K/100% H ₂	-	-	-	-	-	-	-	-	-	+	?	?
Each type of sensor is evaluated for detection, response time, and power requirements according to the following system.												
Detection (D)				Response time (RT)				Power requirements (PR)				
(a) Detects (+)				(a) Less than 3 s (+)				(a) < 1 W (+)				
(b) Inoperative (-)				(b) Less than 45 s (0)				(b) > 1 W (-)				
				(c) Greater than 45 s (-)								
? Indicates unknown or not available.												

Source:

Hunter, G. W. "A Survey and Analysis of Commercially Available Hydrogen Sensors," NASA TM-105878, (1992).

Table A6.3
Sensitivity Limits of Hydrogen Detectors

Principle	Minimum Detection Limits, Average Values					
	In Air			In Nitrogen		
	atm-cc/s	% Hydrogen	% LEL	atm-cc/s	% Hydrogen	Distance (ft)
Catalytic Combustion	8.0	0.02	0.5	80	0.2 ^a	2000 ^b
Bubble Testing	1 x 10 ⁻⁴	NA	NA	1 x 10 ⁻⁴	NA	NA
Sonic-Ultrasonic	1 x 10 ⁻²	NA	NA	1 x 10 ⁻²	NA	100 ^c
Thermal Conductivity	1 x 10 ⁻³	5 x 10 ⁻⁴	0.01	1 x 10 ⁻³	5 x 10 ⁻⁴	----
Gas Density	1 x 10 ⁻²	5 x 10 ⁻³	0.1	1 x 10 ⁻²	5 x 10 ⁻³	NA
Hydrogen Tapes	0.25	1.5	35	----	----	(d)
Scott-Draeger Tubes	----	0.5	13	----	----	NA
Electrochemical	----	0.05	1.2	----	0.05	1000 ^b
Optical Interferometer	----	0.2	5	----	0.2	NA

^a Only one commercial catalytic instrument has claimed to detect hydrogen in nitrogen.

^b The sensing head is remote from readout.

^c For pressure differential of 25 psi with orifice of 0.20 inch.

^d Tape can be placed on suspected leak site and visually checked periodically.

Dashes indicate information is not available.

Source:

Rosen, B., V. H. Dayan, and R. L. Proffitt. "Hydrogen Leak and Fire Detection - A Survey." NASA SP-5092, Washington, DC (1970).

Table A6.4
Typical Hydrogen Fire Detectors

Type of Detector	Description
Temperature Sensor	Thermocouple or resistance temperature device (RTD) that detects the heat of the fire.
Heat Sensitive Cable	Wire or fiber-optic based cable that changes resistance or optical properties if any portion of the cable is exposed to high temperatures or is burned through.
Optical	Ultra-violet, mid/near-infrared, and thermal infrared detectors for the detection of radiation emitted by the hydrogen flame. Infrared detectors must be optimized for hydrogen flame emissions that are not the same as hydrocarbon fires.
Broadband Imaging	Thermal or mid-infrared imaging systems effectively image hydrogen flames but require an operator to interpret the image for detection of fire.
Narrow band Imaging	Band-pass filters centered around the 950, 1100, and 1400 nm peaks can produce adequate images with low-cost silicon CCD cameras, image converter tubes, and vidicon systems. The filters must be carefully selected to block unwanted solar background while optimizing the imaging band for atmospheric transmission of the hydrogen fire radiation.
Brooms/Dust	Putting flammable objects or dust particles into a hydrogen flame will cause the flame to emit in the visible spectrum. Corn straw brooms, dirt, and dry fire extinguishers have been used for this purpose.

Source:

Barnes, H. L. Private communication, NASA Stennis Space Center (1994).

A.7 ACCIDENTS INVOLVING HYDROGEN

Table A7.1
Hydrogen Accidents - Industrial

Category	Number of Incidents	Percentage Total Accidents
Undetected Leaks	32	22
Hydrogen-Oxygen Off-gassing Explosions	25	17
Piping and Pressure Vessel Ruptures	21	14
Inadequate Inert Gas Purging	12	8
Vent and Exhaust System Incidents	10	7
Hydrogen-Chlorine Incidents	10	7
Others	<u>35</u>	<u>25</u>
Total	145	100

Source:

Zalosh, R. G., and T. P. Short. *Comparative Analysis of Hydrogen Fires and Explosion Incidents*. C00-4442-2, Factory Mutual Research Corp., Norwood, MA (1978).

Zalosh, R. G., and T. P. Short. *Compilation and Analysis of Hydrogen Accident Reports*. C00-4442-4, Factory Mutual Research Corp., Norwood, MA (1978).

Table A7.2
Hydrogen Accidents - Ammonia Plants

Classification	Number
Gaskets:	46
Equipment flanges	23
Piping flanges	16
Valve flanges	7
Valve packing	10
Oil leaks	24
Transfer header	9
Auxiliary boiler	8
Primary reformer	7
Cooling tower	3
Electrical	2
Miscellaneous	16

Source:

Williams, G. P. "Causes of Ammonia Plant Shutdowns." *Chemical Engineering Progress*, Vol. 74 (9), (1978).

Table A7.3
Hydrogen Accidents - Aerospace

Description	Accidents Involving Release of Hydrogen	Percentage of Total Accidents
Accidents Involving Release of Liquid or Gaseous Hydrogen	87	81
Location of Hydrogen Release:		
To atmosphere	71 ^a	66
To enclosures (piping, containers, etc.)	26 ^a	24
Ignition of Hydrogen Releases:		
To atmosphere	44	41
To enclosures	24	22
^a Hydrogen was released to both locations in 10 accidents.		

Source:

Ordin, P. M. "A Review of Hydrogen Accidents and Incidents in NASA Operations," In *9th Intersociety Energy Conversion Engineering Conference*. New York: ASME, (1974).

REFERENCES

- ASME B31.3. *Process Piping*. American Society of Mechanical Engineers, New York, NY (1996).
- Barnes, H.L. Private communication, NASA Stennis Space Center (1995).
- Benz, F. J., C. V. Bishop, and M. D. Pedley. "Ignition and Thermal Hazards of Selected Aerospace Fluids: Overview, Data, and Procedures." NASA White Sands Test Facility, Las Cruces, NM (1988).
- Brown, W. F., Jr., H. Mindlin, and C. Y. Ho, Editors. "Aerospace Structural Metals Handbook." CINDAS/USAF CRDA Handbooks Operation, Purdue University, West Lafayette, IN (1996).
- Brzustowski, T. A., S R. Gollahalli, and H. F. Sullivan, "The Turbulent Hydrogen Diffusion Flame in a Cross-Wind," *Comb. Sci. Tech.*, 11(1-2), (1975).
- Chandler, W. T. and R. J. Walter, "Testing to Determine the Effect of High Pressure Hydrogen Environments on the Mechanical Properties of Metals," in *Hydrogen Embrittlement Testing*, ASTM 543, American Society for Testing and Materials, Philadelphia, PA (1974): pp. 170-197.
- Chandler, W. T., and R. J. Walter. "Hydrogen Environment Embrittlement of Metals and Its Control," *Hydrogen Energy*, Proceedings of the *Hydrogen Miami Energy Conference*, T. H. Veziroglu, Ed., Plenum Press (1975): pp. 1057-1058.
- Coley, G. D. and J. E. Field. "Role of Cavities in the Initiation and Growth of Explosions in Liquids." *Proceedings of the Royal Society of London Series A*, 335 (1600), (1973): pp. 67-86.
- Coward, H. F. and G. W. Jones. "Limits of Flammability of Gases and Vapors." Bureau of Mines Bulletin 503, N70-74476; AD-701575 (1952).
- Creitz, E. C. "Inhibition of Diffusion Flames by Methyl Bromide and Trifluoromethyl-Bromide Applied to the Fuel and Oxygen Sides of the Reaction Zone." *Journal of Research for Applied Physics and Chemistry*, 65A (1961): pp. 389-396.
- DoD 6055.9. "Ammunition and Explosives Safety Standards." Department of Defense, (1992).
- Durham, T. F., R. M. McClintock, and R. P. Reed. "Cryogenic Materials Data Handbook." Office of Technical Services, Washington, DC (1962).

- Gray H. R., "Testing for Hydrogen Environment Embrittlement: Experimental Variables," Hydrogen Embrittlement Testing, American Society for Testing and Materials, Special Technical Publication, ASTM STP-543, Philadelphia, PA (1974): pp. 133-151
- Groenvald, T. D. and A. D. Elcea. "Hydrogen Stress Cracking in Natural Gas Transmission Pipelines," *Hydrogen in Metals*, I. M. Bernstein and A. W. Thompson, Eds., ASM (1974).
- Grumer, J., A Strasser, J. M. Singer, P. M. Gussey, and V. R. Rowe. "Hydrogen Flare Stack Diffusion Flames: Low and High Flow Instabilities, Burning Rates, Dilution Limits, Temperatures, and Wind Effects," BM-RI-7457, Bureau of Mines Report of Investigation (1970).
- Hunter, G. W. "A Survey and Analysis of Commercially Available Hydrogen Sensors," NASA TM-105878, 1992.
- Hoover, W. R., et. al. *Hydrogen Compatibility of Structural Materials for Energy Storage and Transmission Applications*. Sandia National Laboratories, SAND80-8202, Livermore, CA February (1980).
- Jones, G. W. and G. St. J. Perrott. "Oxygen Required for the Propagation of Hydrogen, Carbon Monoxide, and Methane Flames". *Ind. Eng. Chem.*, 19 (9), (1927): pp. 985-989.
- Johnson, V. J., Ed. "A Compendium of the Properties of Materials at Low Temperature (Phase I)," WADD Technical Report 60-56, Part II, Properties of Solids, Office of Technical Services, United States Department of Commerce, Washington, DC (1960).
- Kent, G. R. "Find Radiation Effects of Flares," *Hydrocarbon Processing*. 47 (6), (1968): pp. 119-130.
- Lee, J. H., R. Kynstantus, C. M. Guirao, W. A. Benedick, and J. E. Shepherd. "Hydrogen-Air Detonations." Proceedings of the *2nd International Workshop on the Impact of Hydrogen on Water Reactor Safety*. M. Berman, Ed., SAND82-2456, Sandia National Laboratories, Albuquerque, NM, October (1982).
- Liebenberg, D. H., J. K. Novak, and F. J. Edeskuty. "Cooldown of Cryogenic Transfer Systems." *AIAA 3rd Propulsion Joint Specialist Conference*, AIAA Paper No. 67-475, Washington, DC, July 17-21 (1967).
- A. D. Little, Inc., "An Investigation of Hazards Associated with the Storage and Handling of Liquid Hydrogen," AD 324/94, A. D. Little, Inc., Cambridge, MA, March (1960).
- LNG Materials and Fluids: A User's Manual of Property Data in Graphic Format*, D. Mann, Ed., National Bureau of Standards, Boulder, CO (1977).

- McCarty, R. D., J. Hord, and H. M. Roder. *Selected Properties of Hydrogen (Engineering Design Data)*. NBS Monograph 168, National Bureau of Standards, Boulder, CO (1981).
- McClintock, R. M. and H. P. Gibbons. *Mechanical Properties of Structural Materials at Low Temperatures, A Compilation from the Literature*. National Bureau of Standards, Monograph 13, United States Department of Commerce, Washington, DC (1960).
- McHale, E. T., R. W. Geary, G. von Elbe, and C. Huggett. "Flammability Limits of $\text{GH}_2\text{-GO}_2\text{-Fluorocarbon}$ Mixtures." *Combustion and Flame*, 16 (2), (1971): pp. 167-175.
- Mellish, C. E. and J. W. Linnett. "The Influence of Inert Gases on Some Flame Phenomena." *4th Symposium (International) Combustion*, Baltimore, MD (1953): pp. 407-420.
- NFPA 50. "Bulk Oxygen Systems at Consumer Sites." National Fire Protection Association, Inc., Quincy, MA (1990).
- NFPA 51. "Design and Installation of Oxygen-Fuel Gas Systems for Welding, Cutting, and Allied Processes." National Fire Protection Association, Inc., Quincy, MA (1992).
- Novak, J. K. "Cooldown Flow Rate Limits Imposed by Thermal Stresses in Liquid Hydrogen or Nitrogen Pipelines." *Advances in Cryogenic Engineering*, Vol. 15, K. D. Timmerhaus, Ed., Plenum Press, New York, (1970): pp. 346-353.
- NSS 1740.12. "NASA Safety Standard for Explosives, Propellants, and Pyrotechnics." National Aeronautics and Space Administration, Washington, DC (1993).
- Ordin, P. M. "A Review of Hydrogen Accidents and Incidents in NASA Operations," In *9th Intersociety Energy Conversion Engineering Conference*, New York, ASME, 1974.
- Ordin, P. M., and R. C. Carter, "Clinch River Breeder Reactor Hydrogen Disposal and Ignition System," ARSD-00093, General Electric, June (1980).
- Payman, W. and H. Titman. "Limits of Inflammability of Hydrogen and Deuterium in Oxygen and Air." *Nature*, 137 (1936): pp. 160-168.
- Peterson, P. "Explosions in Flare Stacks," *Chem. Eng. Prog.*, 63(8), August (1967): pp. 67-70.
- "Properties of Teflon[®] at Cryogenic Temperatures," E. I. du Pont de Nemours and Co., Wilmington, DE (1976).
- Reed, R. P., R. E. Schramm, and A. F. Clark. "Mechanical, Thermal, and Electrical Properties of Selected Polymers," *Cryogenics*. February (1973): pp. 67-82.

- Robinson, S. L. "Hydrogen Compatibility of Structural Materials for Energy Storage and Transmission Applications." Sandia National Laboratories, SAND77-8240, June (1977).
- Rosen, B., V. H. Dayan, and R. L. Proffitt. "Hydrogen Leak and Fire Detection - A Survey." NASA SP-5092, Washington, DC (1970).
- Siegel, R. and J. R. Howell. "Thermal Radiation Heat Transfer. Vol 3: Radiation Transfer with Absorbing, Emitting, and Scattering Media." NASA SP-164: Vol. 3 (1971).
- Schwartzberg, F. R., S. H. Osgood, and R. G. Herzog. "Cryogenic Materials Data Handbook." Air Force Materials Laboratory, AFML-TDR-64-280, Supplement 4, Vol. II. Wright-Patterson AFB, OH, August, 1968.
- Stuhrke, W. F., and J. L. Carpenter. "Fracture Toughness and Testing Data - A Technology Survey." NASA-CR-134752, January, 1975.
- Wigley, D. A. and P. Halford. "Materials of Construction and Techniques of Fabrication." *Cryogenic Fundamentals*, G. G. Haselden, Ed., Chapter 6, Academic Press, London (1971).
- Williams, G. P. "Causes of Ammonia Plant Shutdowns." *Chemical Engineering Prog.*, 74 (9), (1978).
- Zalosh, R. G. and T. P. Short. "Comparative Analysis of Hydrogen Fires and Explosion Incidents." C00-4442-2, Factory Mutual Research Corp., Norwood, MA (1978).
- Zalosh, R. G. and T. P. Short. "Compilation and Analysis of Hydrogen Accident Reports." C00-4442-4, Factory Mutual Research Corp., Norwood, MA (1978).
- Zebetakis, M. G. and D. S. Burgess. "Research on the Hazards Associated With the Production and Handling of Liquid Hydrogen." BM-RI-5707, Bureau of Mines Report of Investigation, Washington, DC (1961).

APPENDIX B

ASSESSMENT EXAMPLES

EXAMPLE 1:

Detonation of GH_2 with air/oxygen.

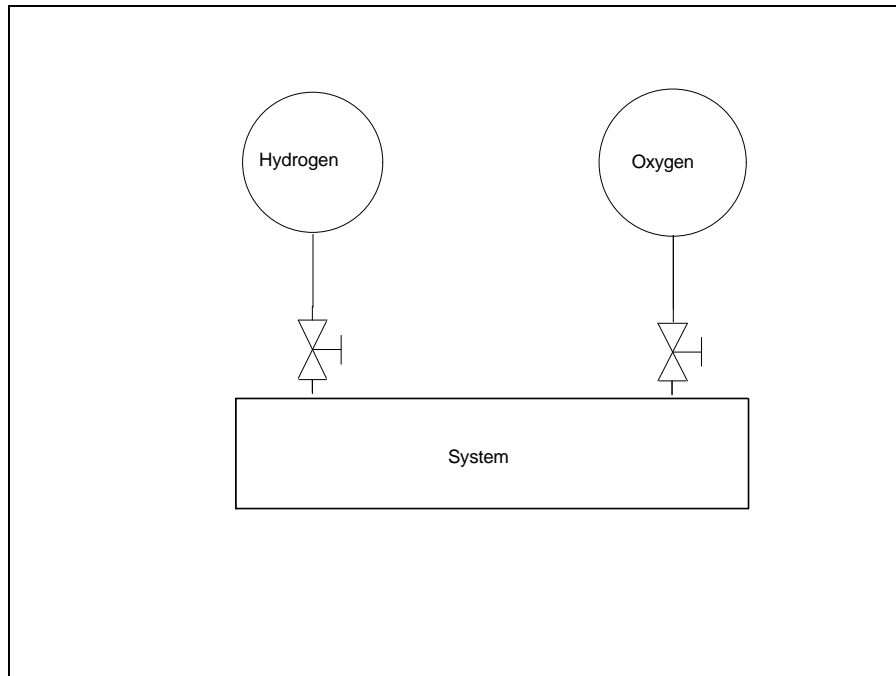

STATEMENT OF ASSESSMENT:

The inadvertent introduction of GH_2 into a volume containing air-oxygen or the reverse process is the source of many of the industrial and aerospace accidents summarized in Tables A7.1, A7.2 and A7.3. Hazard analysis requires values for pressures and temperatures that occur with detonation of the mixture.

SOLUTION:

The Gordon-McBride (1994) program uses Joint Army-Navy-NASA-Air Force (JANNAF) thermodynamic data and performs equilibrium calculations. Table B1 shows the computed values for a range of mixtures.

Table B1
Detonation Pressures and Temperatures

Volume % H ₂	T ₀ ^a (K)	P ₀ ^b (kPa)	T ₁ /T ₀	P ₁ /P ₀	T ₀ (K)	P ₀ (kPa)	T ₁ /T ₀	P ₁ /P ₀
Hydrogen/Air								
18.3	298	101.3	7.657	12.154	298	10.1	7.580	12.111
25	298	101.3	9.257	14.605	298	10.1	8.870	14.223
50	298	101.3	8.706	13.713	298	10.1	8.482	13.555
59	298	101.3	7.678	12.144	298	10.1	7.601	12.119
Hydrogen/Oxygen								
5	298	101.3	3.118	4.880	298	10.1	3.119	4.882
25	298	101.3	9.034	14.289	298	10.1	8.660	13.896
50	298	101.3	11.646	17.857	298	10.1	10.537	16.616
75	298	101.3	12.111	18.671	298	10.1	10.834	17.250
90	298	101.3	8.576	13.584	298	10.1	8.327	13.393

^a T = temperature
^b P = pressure

The T₁/T₀ and P₁/P₀ ratios give the temperature and pressure rise across the detonation shock. These are equilibrium (Chapman-Jouguet) values. The examples calculated are for a tenfold change in initial pressure (101.3 kPa and 10.1 kPa). The temperature and pressure rise across the detonation shock is similar in relative change.

EXAMPLE 2:

Deflagration of Hydrogen with air/oxygen.

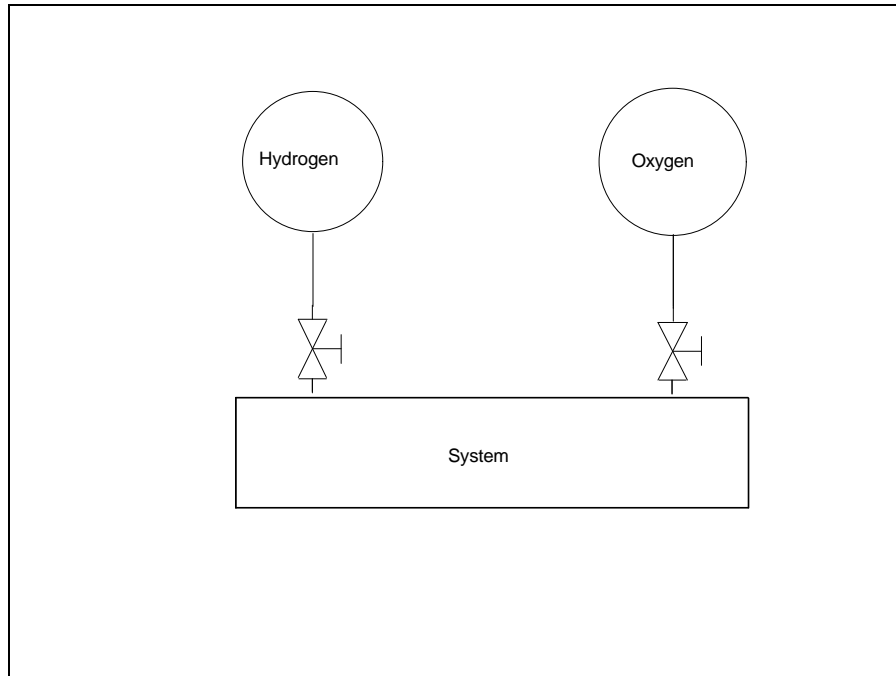

STATEMENT OF ASSESSMENT:

In those incidents where hydrogen is inadvertently mixed with air or oxygen and only deflagration occurs, the potential hazards are transformation to detonation, fire damage to surrounding equipment or injury to personnel and potential explosion of the fire heating the contents of its vessel. Analysis of the latter case gives the designer an estimate of the pressure that could occur within the vessel.

Only mixtures that fall within the flammability limits shown in Figure A2.1 need to be considered. To use Figure A2.1, consider points in the lower portion of the figure. A point defined by 10% hydrogen/10% oxygen/80% nitrogen is flammable. A point defined by 2% hydrogen/3% oxygen/90% nitrogen is not flammable.

SOLUTION:

The calculation involves a given amount of hydrogen and oxidizer mixed in a specific volume. The system shown in the schematic is assumed to be 2 m³. B2 gives the temperature and pressure in the vessel for a range of compositions. The Gordon-McBride (1994) computer code provides the computations. The Gordon-McBride (1994) program uses Joint Army-Navy-NASA-Air Force (JANNAF) thermodynamic data and performs equilibrium calculations.

Table B2
Deflagration Pressures

Volume % H ₂	T _o (K)	P _o (kPa)	T _f ^a (K)	P _f ^a (kPa)	T _o (K)	P _o (kPa)	T _f (K)	P _f (kPa)
Hydrogen/Air								
5	298	101.3	707.9	234.7	273	101.3	684.3	247.6
25	298	101.3	2159.2	643.8	273	101.3	2141.9	697.0
50	298	101.3	1937.9	590.0	273	101.3	1917.7	637.3
75	298	101.3	1165.7	375.6	273	101.3	1142.6	401.9
Hydrogen/Oxygen								
5	298	101.3	694.2	230.1	273	101.3	671.6	243.0
25	298	101.3	2134.5	639.1	273	101.3	2118.3	692.2
50	298	101.3	2913.0	808.5	273	101.3	2908.3	880.0
75	298	101.3	3003.4	837.5	273	101.3	2999.2	911.6
90	298	101.3	1899.2	581.4	273	101.3	1878.6	612.2
95	298	101.3	1132.8	365.9	273	101.3	1132.8	399.4

^a T_f and P_f are the final temperature and pressure that would occur in the fixed volume (2 m³) when thermodynamic equilibrium occurred.

EXAMPLE 3:

Calculation of the pressure rise with temperature for both LH₂ and SLH₂.

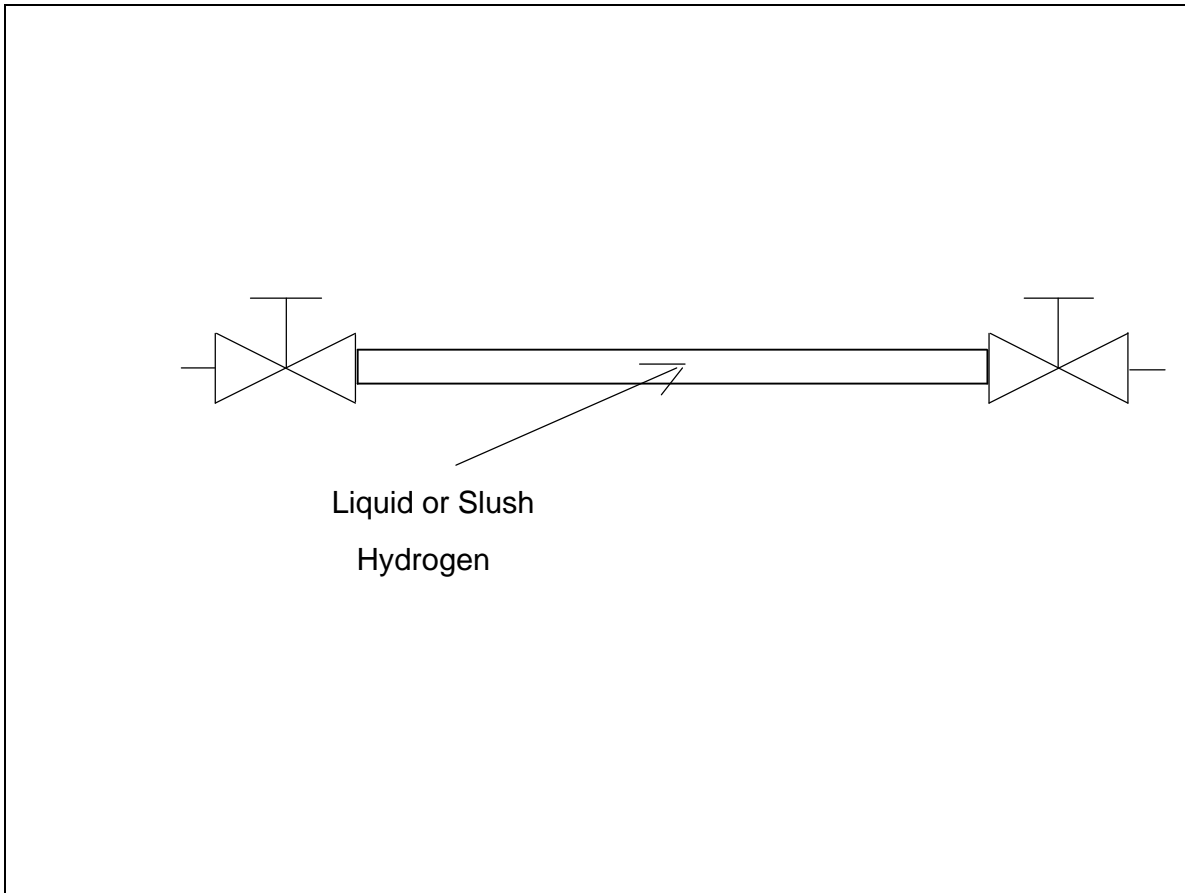

STATEMENT OF ASSESSMENT:

The possibility of liquid lockup, the blocking of a section of transfer line completely filled (no ullage) with LH₂ or SLH₂, can be safely avoided with proper design. Should such a situation occur, the resulting pressures as the system heats can lead to system damage or hydrogen leakage. Heating occurs through normal operation because there is a significant temperature difference between the LH₂ or SLH₂ and surroundings (at ambient). Standard storage system designs usually assume a heat leak equivalent to 0.5 percent/day of the liquid contents.

SOLUTION:

- a. The liquid lockup calculation gives the following pressure increase for the corresponding temperature increase. The calculation follows:

$$\left(\frac{\partial R}{\partial T}\right)_V = -\frac{\left(\frac{\partial V}{\partial T}\right)_R}{\left(\frac{\partial V}{\partial R}\right)_T} = \frac{\alpha}{\kappa} \quad (\text{Eq. B1})$$

where:

α = the coefficient of thermal expansion

κ = is the coefficient of isothermal compressibility (Lewis and Randall 1961).

This can be integrated (assuming constant property values) to obtain the following:

$$P = \frac{\alpha}{\kappa} DT + P_0 \quad (\text{Eq. B2})$$

At 20.2 K and $P_0 = 0.101$ MPa

$$\alpha = 0.01638 \text{ K}^{-1}$$

$$\kappa = \frac{1}{50.4463} \text{ MPa}^{-1}$$

The property values are from McCarty, Hord, and Roder (1981). Results are given in Table B3.

Table B3
Liquid-Lockup Pressure Change

Given: LH ₂ at T ₀ = 15 K		
ΔT (K)	ΔP kPa	(psia)
0.5	413	(60)
1.0	826	(120)
5.0	4130	(600)
10.0	8260	(1200)

- b. The pressure rise for SLH₂ can occur at constant temperature; the partial molar volume of solid is less than that of liquid: hence, the melting of solid hydrogen increases the volume of liquid. The following values for SLH₂ and LH₂ are obtained from Table A1.1:

$$\text{density LH}_2 = 77.03 \text{ kg/m}^3$$

$$\text{density SLH}_2 (50\% \text{ mass}) = 81.50 \text{ kg/m}^3$$

One cubic meter of 50 percent mass SLH₂ contains 81.50 kg; therefore, as LH₂ 50 percent mass would occupy 1.06 m³. Under a liquid lockup situation, the melting of the solid hydrogen would lead to the formation of increased volume. If no ullage were present the system pressure would rise; however, as the pressure rises, the melting temperature changes (Figure A1.10). The actual system pressure would be increasing and if the temperature rose 0.4 K, the melting pressure of the solid would be 1.2 MPa plus the corresponding increase caused by the change in temperature of the rest of the liquid (part a. of this example).

NOTE

Liquid lockup of cryogenic systems is possible if the LH₂ is isolated (not readily hydraulically connected) so pressure increases within the system are not distributed to a relief valve or burst disc.

EXAMPLE 4:

Analysis of heat leak on LH₂ and ortho-to-para conversion and resulting effects on SLH₂ systems.

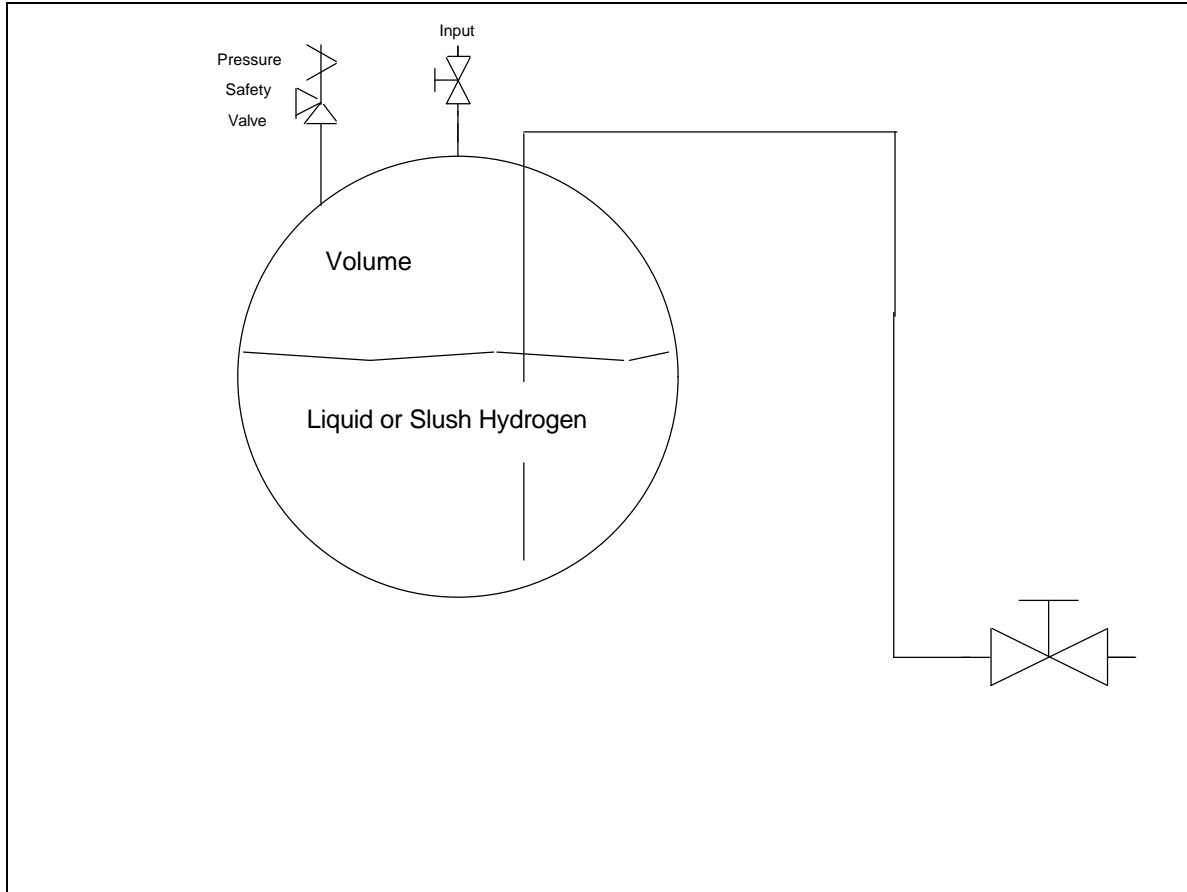

STATEMENT OF ASSESSMENT:

While LH₂ and SLH₂ storage systems are designed to minimize heat leaks, there is still a finite rate at which thermal energy enters the stored material. The value assumed usually is a rate of 0.5 percent of the stored contents per 24 h.

SOLUTION:

- a. Assume 100 m³ storage (plus 10 percent ullage) of LH₂. What is the pressure rise per day as a result of evaporated liquid? (Neglect effect of pressure increase on evaporation rate.) Assume LH₂ normal hydrogen.

Data: LH₂ stored at 20.4 K (normal boiling point) P₀ = 101.3 kPa

$$\text{Amount Evaporated} = 0.005 \cdot 100 \text{ m}^3 = 0.5 \text{ m}^3$$

$$\text{Mass Evaporated} = M_{\text{VAP}} = 70.91 \text{ kg/m}^3 \cdot 0.5 \text{ m}^3 = 35.5 \text{ kg}$$

Density from Table A1.2 includes:

$$\text{Moles Evaporated } n_{\text{VAP}} = 1.760 \times 10^4 \text{ moles}$$

Initial moles in ullage (assume ideal gas law applies)

$$n_0 = \frac{PV}{RT} \quad (\text{Eq. B3})$$

$$n_0 = \frac{101.3 \text{ kPa} \cdot 10 \text{ m}^3}{\left(\frac{101.3 \text{ kPa} \cdot 0.0224 \text{ m}^3}{1 \text{ mol} \cdot 273 \text{ K}} \right) \cdot 20.4 \text{ K}} = 6000 \text{ moles}$$

$$P_f = (n_0 + n_v) \left(\frac{RT}{V} \right) \quad (\text{Eq. B4})$$

Final pressure:

$$\frac{\left(1.760 \cdot 10^4 + 0.6000 \cdot 10^4 \right) \cdot \left(\frac{101.3 \cdot 0.0224}{1 \text{ mol} \cdot 273 \text{ K}} \right) \cdot (20.4 \text{ K})}{10 \text{ m}^3} = 400 \text{ kPa (58 psia)}$$

If the compressibility of the hydrogen vapor is considered Z = 0.905 (Table A1.2) the final pressure is 362 kPa (52.5 psia).

- b. Assume 100 m³ storage (plus 10 percent ullage) of SLH₂.
- (1) The SLH₂ is 50 mass percent solids and assume the solid initially is 80 percent para-hydrogen and 20 percent ortho-hydrogen.
 - (2) Because the equilibrium vapor pressure of SLH₂ is 7.20 kPa (Table A1.2), assume the SLH₂ is under a blanket of helium to bring the initial pressure to 101.3 kPa.

- (3) The equilibrium temperature of the SLH₂ is 13.96 K; therefore, the temperature difference for heat leak is greater than in the LH₂ case and 0.5 percent/day rate will assume an appropriate amount of solid-liquid phase change.

Total Initial Mass LH ₂	=	4075 kg
Total Initial Mass Solid	=	4075 kg
Initial Mass Para Solid	=	3260 kg
Initial Mass Ortho Solid	=	815 kg

Assume the total thermal energy entering the system by the heat leak is the same as in part a.

$$Q = M_{\text{VAP}} \cdot \Delta H_{\text{VAP}} \quad (\text{Eq. B5})$$

$$Q = 35.5 \text{ kg} \cdot 10^3 \text{ g/kg} \cdot 446 \text{ J/g} = 1.583 \cdot 10^7 \text{ J}$$

Latent Heat of Vaporization from Table A1.1.

Thermal energy from ortho-to-para conversion

$$\Delta H_{\text{CONV}} = 815 \text{ kg} \cdot 10^3 \text{ g/kg} \cdot 525 \text{ J/g} = 4.279 \cdot 10^8 \text{ J}$$

Enthalpy of Conversion from Figure A1.2.

$$\text{Total Solid Melted} = \frac{(1.583 \cdot 10^7 + 4.279 \cdot 10^7)}{58.3} = 7611 \text{ kg} \quad (\text{Eq. B6})$$

Latent Heat of fusion from Table A1.1.

The combined heat leak and ortho-to-para conversion would result in sufficient thermal energy to melt all the solid because there was originally 4075 kg of solid hydrogen. This result points to the need for lower heat input or continuous regeneration of SLH₂. If this is accomplished, the ortho-to-para conversion could be accomplished external to the storage vessel and with external regeneration of solid the vessel pressure could be maintained at its original value. It is also important to note that the equilibrium triple point pressure is 7.20 kPa and without the helium blanket the storage vessel would be at negative pressure with respect to ambient.

EXAMPLE 5:

Amount of solid insulation (not vacuum) required for a specified test line.

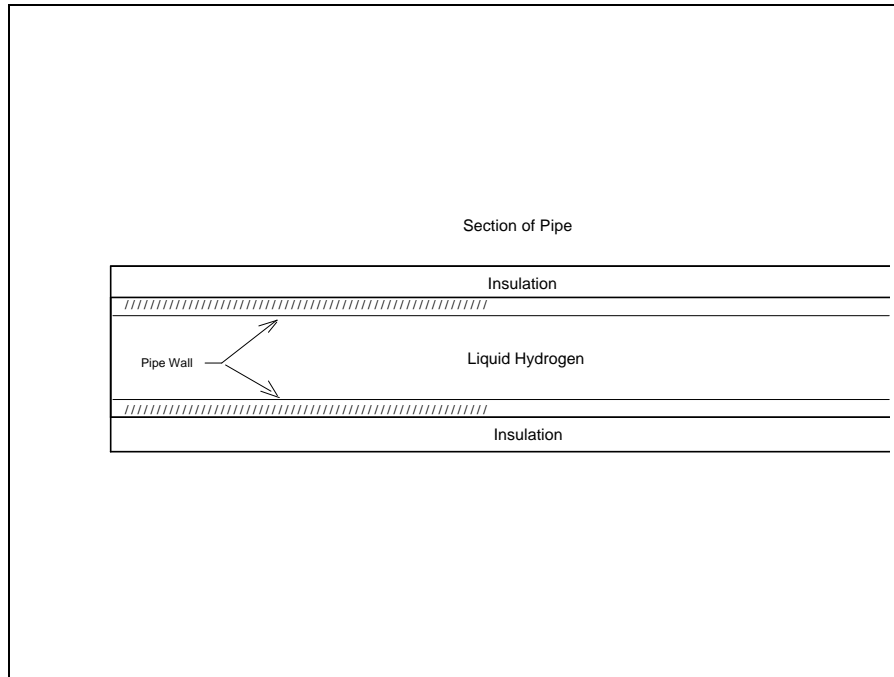

Given: 2 in. ID (nominal) line 304 stainless steel pipe. Generally, liquid flow velocity is less than 10 ft/s and assume heat leak is less than 1/2 percent of line capacity when in use at steady rate.

Basis: 10 m line; LH₂ at 20.3 K. Line is used to transfer 100.0 m³ LH₂.

Pipe Dimensions:

Length and size	10 m, 2 in. Schedule 40
Wall Thickness	3.91 mm
Inside Diameter	52.50 mm
Outside Diameter	60.33 mm
Inside Cross Section	$21.64 \cdot 10^{-4} \text{ m}^2$
Density from Table A1.1	70.78 kg/m^3
Total Mass LH ₂	$100.0 \text{ m}^3 \cdot 70.78 \text{ kg/m}^3 = 7.078 \cdot 10^3 \text{ kg}$
Total Transferred (with heat leak)	$7.078 \cdot 10^3 \text{ kg} (1.0 + 0.005) = 7113.4 \text{ kg}$

Total thermal energy leaking into the system. Assume leak only causes phase change.

$$= (7113.4 - 7078) \text{ kg} \cdot 445.6 \text{ kJ/kg} = 1.577 \times 10^4 \text{ kJ}$$

Latent Heat of Vaporization for parahydrogen from Table A1.1 = 445.6 kJ/kg

Length of time to accomplish operation. Assume flow is at 3 m/s (10 ft/s).

$$\text{Volumetric Flow} = 3 \text{ m/s} \cdot 21.64 \cdot 10^{-4} \text{ m}^2 = 6.492 \cdot 10^{-3} \text{ m}^3/\text{s}$$

$$\text{Time} = 100.0 \text{ m}^3 / 6.495 \cdot 10^{-3} \text{ m}^3/\text{s} = 1.5396 \cdot 10^4 \text{ s} = 4.3 \text{ h}$$

Inner Surface Area

$$\text{of Pipe} = \pi d_i \cdot L = \pi \cdot 0.05250 \text{ m} \cdot 10.0 \text{ m} = 1.6493 \text{ m}^2$$

$$\text{Thermal Flux} = 1.577 \cdot 10^4 \text{ kJ} / (1.6493 \text{ m}^2 \cdot 4.3 \text{ h}) = 0.618 \text{ kJ/m}^2 \cdot \text{s}$$

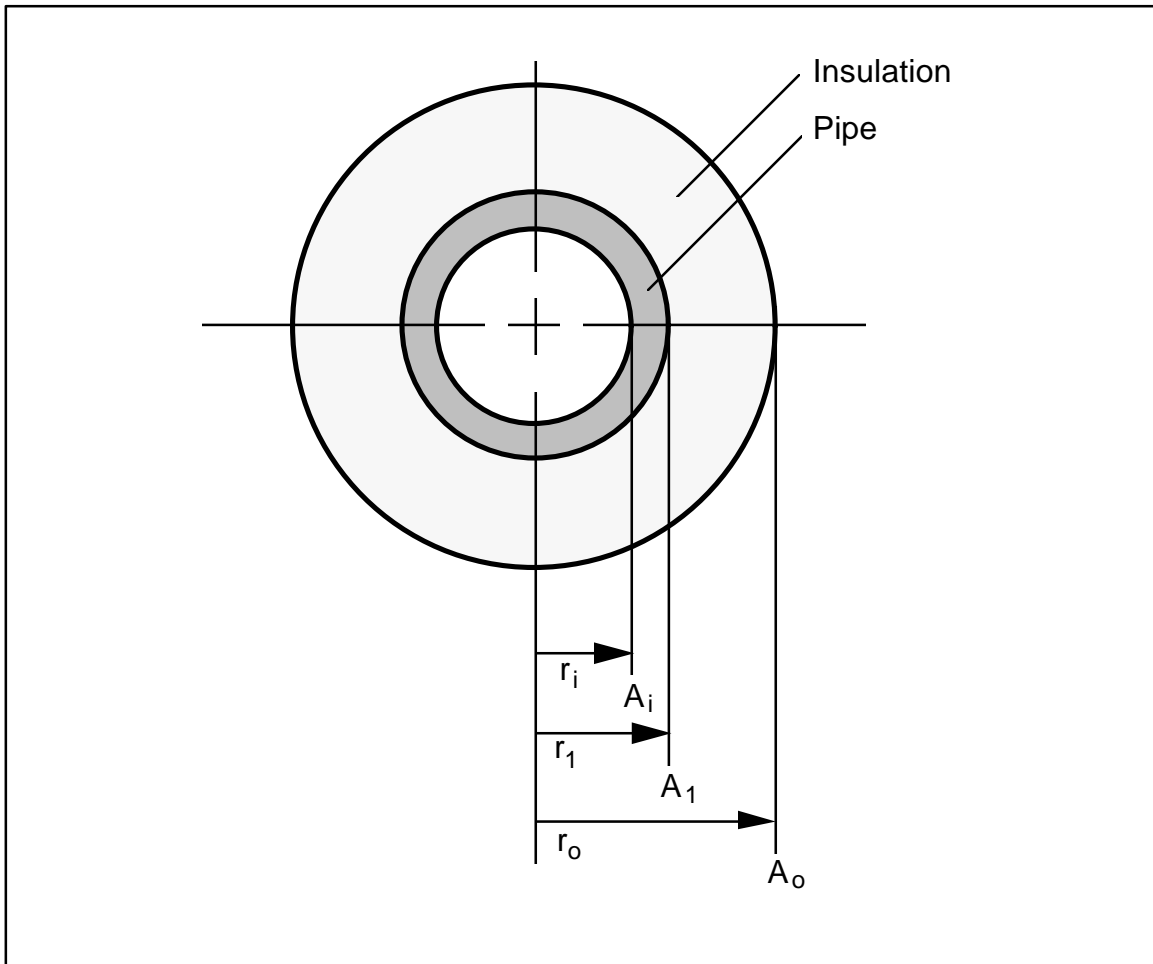

$$q_{\text{SPECIFIED}} = 1.6493 \text{ m}^2 \cdot 0.618 \text{ kJ/m}^2 \cdot \text{s} = 1019 \text{ W}$$

$$q_{\text{CALC}} = U_i A_i (T_{\text{AMB}} - T_{\text{LH2}})$$

$$U_i = \frac{1}{\frac{1}{h_i} + \frac{x A_i}{k_x A_{\text{lmx}}} + \frac{y A_i}{k_y A_{\text{lmy}}} + \frac{A_i}{h_o A_o}} \quad (\text{Eq. B7})$$

$$h_i = \text{liquid film transfer coefficient} = 55 \frac{\text{W}}{\text{m}^2 \cdot \text{K}}$$

$$x = \text{pipe wall thickness} = 0.00391 \text{ m}$$

$$k_x = \text{pipe thermal conductivity} = 16.3 \frac{\text{W}}{\text{m}^2 \cdot \text{K}}$$

$$A_i = \text{inside pipe surface area} = 1.65 \text{ m}^2 \text{ (Geankoplis 1983)}$$

$$A_{\text{lmx}} = \frac{(A_1 - A_i)}{\ln\left(\frac{A_0}{A_i}\right)} \approx A_i \quad (\text{Eq. B8})$$

$$y = \text{insulation thickness} = \text{unknown}$$

$$k_y = \text{insulation (Magnesia, 85\%) thermal conductivity} = 0.05 \frac{\text{W}}{\text{m}^2 \cdot \text{K}}$$

$$A_{\text{lmx}} = \frac{A_0 - A_i}{\ln\left(\frac{A_0}{A_1}\right)} \approx \frac{A_0 - A_i}{\ln\left(\frac{A_0}{A_i}\right)} \quad (\text{Eq. B9})$$

$$h_o = \text{outside film transfer coefficient} = 5 \frac{\text{W}}{\text{m}^2 \cdot \text{K}}$$

$$A_o = \text{outside area of insulation}$$

The problem is given q , T_{amb} , T_{LH2} , and all parameter values solve for $r_0 \rightarrow A_0$

$$U_i = \frac{1}{0.0182 + 0.00024 + \frac{33.0y}{A_{lmy}} + \frac{0.33}{A_0}} \quad (\text{Eq. B10})$$

$$\begin{aligned} y &= r_0 - 0.0302 \text{ m} \\ A_0 &= 10.0 \text{ m} \cdot 2 \cdot \pi \cdot r_0 \\ T_{LH2} &= 20.3 \text{ K} \\ T_{amb} &= 298 \text{ K} \end{aligned}$$

TRIAL-AND-ERROR SOLUTION:

Assume a value for r_0 , solve for U_i , solve for q_{CALC}

Does $q_{CALC} = q_{SPECIFIED}$?

Let $y = 6 \text{ in.}$, therefore,

$$\begin{aligned} r_0 &= 0.183 \text{ m} \\ y &= 0.152 \text{ m} \\ A_0 &= 11.5 \text{ m}^2 \\ A_{lmy} &= 5.07 \text{ m}^2 \end{aligned}$$

$$U_i = \frac{1}{0.0182 + 0.00024 + 0.989 + 0.029} = 0.965 \frac{\text{W}}{\text{m}^2 \cdot \text{K}}$$

$$q_{CALC} = 0.965(1.65)(298 - 20.3) = 442 \text{ W}$$

$q_{CALC} < q_{SPECIFIED}$ and 6 in. of magnesia insulation would suffice.

Let $y = 3 \text{ in.}$, therefore,

$$\begin{aligned} r_0 &= 0.1064 \text{ m} \\ y &= 0.0762 \text{ m} \\ A_0 &= 6.68 \text{ m}^2 \\ A_{lmy} &= 3.6 \text{ m}^2 \end{aligned}$$

$$U_i = \frac{1}{0.0182 + 0.00024 + 0.698 + 0.0494} = 1.306 \frac{\text{W}}{\text{m}^2 \cdot \text{K}}$$

$$q_{CALC} = 1.306(1.65)(298 - 20.3) = 598 \text{ W}$$

$q_{CALC} < q_{SPECIFIED}$ and 3 in. of magnesia insulation would suffice.

In comparison an uninsulated line would result in

$$q_{\text{CALC}} = \frac{1}{0.0182 + 0.00024 + 0.2} (1.65)(278) = 2100 \text{ W}$$

twice the $q_{\text{SPECIFIED}}$; therefore, it is not acceptable.

NOTE

Under the assumed heat leak (0.5 percent) 393 m³ of GH₂ formed. It is realistic to expect this is unacceptable; therefore, the rate of heat leak would need to be reduced, i.e., a greater level of insulation would be required. Also, this problem assumed steady state operation and does not address the question of system cool down.

ALTERNATIVE ASSESSMENT:

The assumed heat leak corresponds to 100 W/m (460 Btu/ft) for the 5 cm (nominal ID) pipe. As described in the note, this may be excessive and a reduced heat leak would be required. Given the availability of data on heat leak as a function of insulation thickness for various types of insulation, the designer could readily select sufficient insulation. The figure below provides the necessary information (Stewart and Prenger 1991).

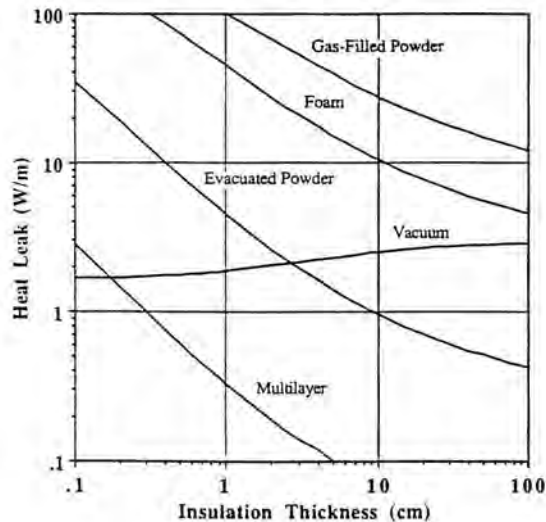

EXAMPLE 6:

Calculation for siting an LH₂ storage dewar.

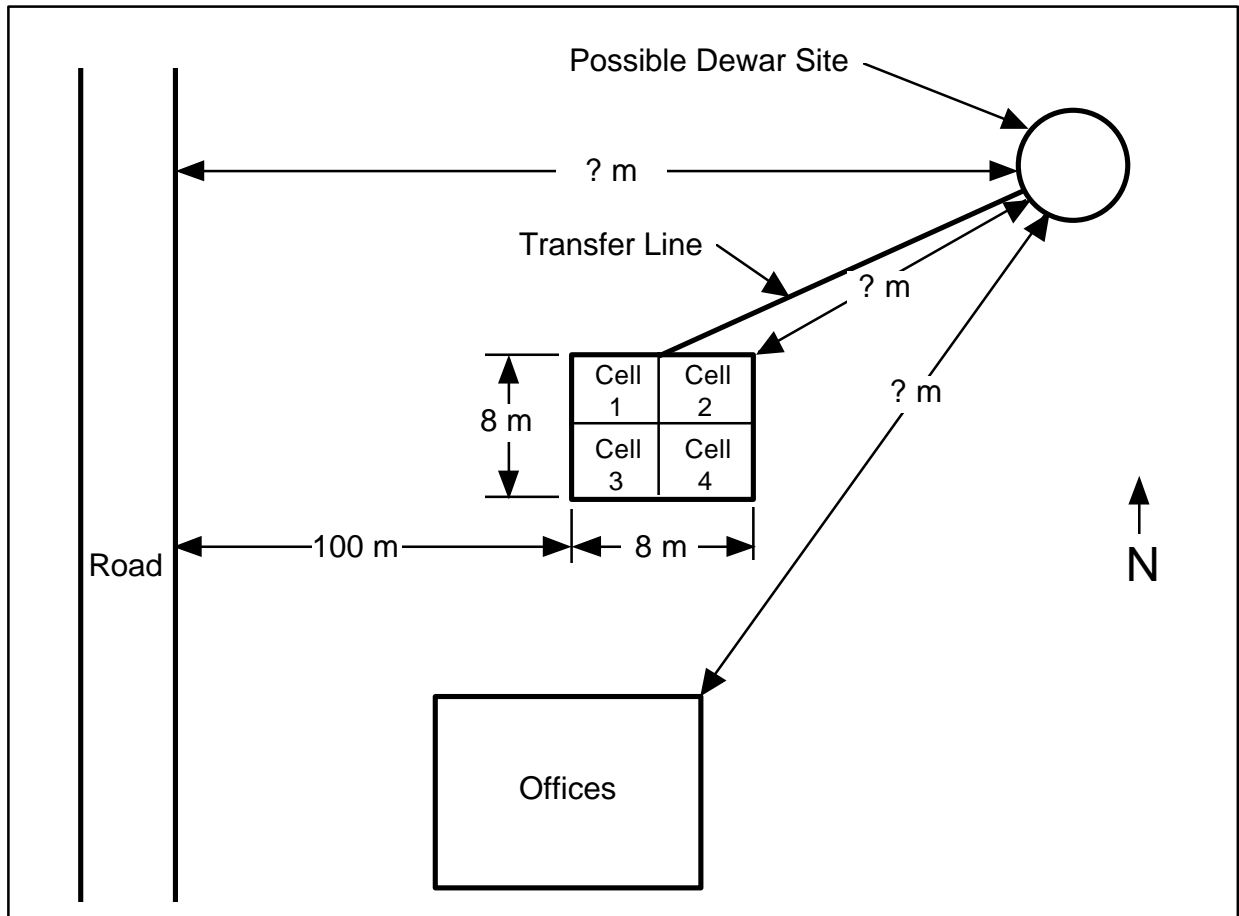

STATEMENT OF ASSESSMENT:

Assume that given the geographical layout shown in the schematic, the problem is to locate a 1000 gal LH₂ dewar to supply experiments conducted in Cell 1 of the schematic.

- a. Cell construction is reinforced concrete wall with vented, flat-poured concrete roof.
- b. Operation of experimental systems within the cells is controlled remotely from the office structure.

Total quantity of LH₂ = 3.785 m³ = 268 kg (589 lb)

The following separation distances are obtained from the sources indicated.

Table B4
Minimum Separation Distances for Siting the LH₂ Dewar in Example 6

	Minimum Separation Distance [m (ft)]	
	Nonpropellant Use	Propellant Use
From LH ₂ storage dewar to public roadway	7.6 (25) ^a	183 (600) ^{b,c}
From LH ₂ storage dewar to test cells	1.5 (5) ^a	41 (135) ^{b,d}
From LH ₂ storage dewar offices (place of public assembly)	22.9 (75) ^a	183 (600) ^{b,d}
From Test Cell 1 LH ₂ piping to offices	NS ^e	7.6 (25) ^f
From Test Cell 1 LH ₂ piping to road	NS	NS

^a From Table A3.4.
^b From Table A3.7.
^c A dike or barricade could be placed adjacent to the dewar on its west side to reduce the separation distance to the road.
^d The dewar can be placed on the north side of the cells to reduce hydrogen piping length to Cell 1, assuming cell construction is adequate to provide protection to the office building.
^e Not Specified
^f From Section 405h.(2).

EXAMPLE 7:

Analysis of a pressure relief valve.

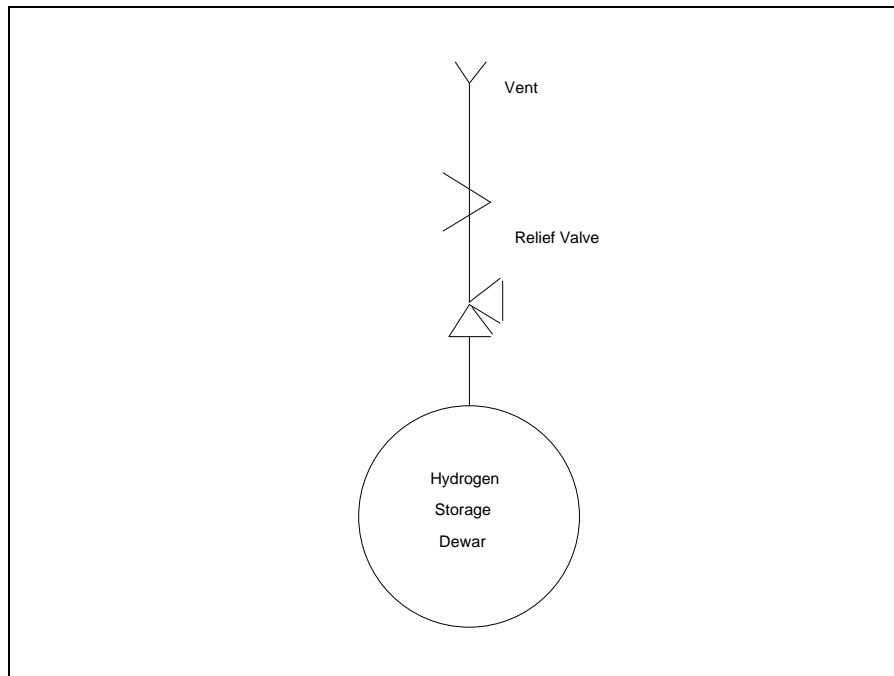

STATEMENT OF ASSESSMENT:

Each system and item of equipment should be examined for operational safety as set forth by specified requirements. Relief capacity is based on the most severe requirement of a system.

SOLUTION:

The sizing of relief devices for safely venting hydrogen vapor or gas requires a calculation of the conditions of critical flow. Critical flow usually will exist for most gases and vapors discharging through the safety valve nozzle and orifice. Critical pressure normally will be found between 53 and 60 percent of the set pressure; critical flow will exist if the downstream or back pressure on the valve is less than 53-60 percent of the initial relief pressure plus overpressure.

Given: 100 m³ storage LH₂ (as in Example 4)
normal evaporation rate = 35.5 kg/24 h = 1.48 kg/h

Assume insulation failure and an evaporation rate = 0.32 kg/s.¹
Assume tank relief valve is set at 75 psia; therefore, critical flow.

The API-ASME² formula for capacity during critical flow.³

$$W = C K A P (M/ZT)^{1/2} \quad (\text{Eq. B11})$$

where:

$$W = \text{lb/h}$$

$$C = 377$$

$$K = 0.97$$

$$P = 75 \text{ psia}$$

$$M = 2.016 \text{ lb/lb}\cdot\text{mol}$$

$$Z = 0.9$$

$$T = 36.5 \text{ }^\circ\text{R}$$

Given the mass flow of 0.32 kg/s (2.54x10³ lb/h) and using equation B11, the area is calculated as 0.374 in².

The calculated diameter of the safety relief valve orifice is 0.75 in. (1.91 cm) based on a two to one safety factor.

NOTE

The diameter of the relief device should be sized to keep the storage vessel from reaching critical flow, otherwise the tank can continue to build pressure. Given the variability in the heat leak value a 2:1 safety factor might be reasonable. A more conservative safety factor could be used if the heat leak is known.

¹ The evaporation rate value is calculated based on a spherical volume of 110 m³ LH₂ storage (includes 10 percent ullage). The surface area for heat transfer would be 111 m² and an overall heat transfer coefficient of $U = 4.7 \text{ W/m}^2\cdot\text{K}$ (uninsulated system, Example 5) results in heat leak of $1.45 \times 10^5 \text{ W}$.

² American Petroleum Institute and American Society of Mechanical Engineers

³ Equation B11 is found on page 225, Volume 1 of E. E. Ludwig "Applied Process Design for Chemical and Petrochemical Plants" and the values of C and K are from this source.

EXAMPLE 8:

Analysis of a hydrogen vent/flare system.

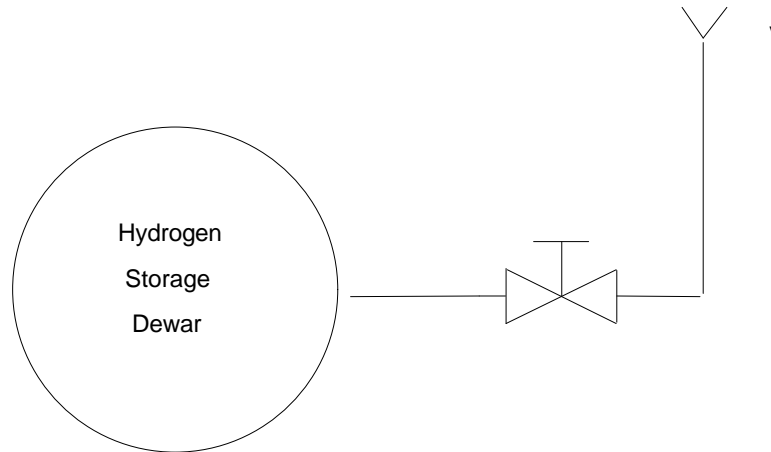

STATEMENT OF ASSESSMENT:

Assume the same quantity of flow exists as in Example 7 (0.3 kg/s). This flow is the upper limit of the quantity that has been vented without flaring (Section 505 b); therefore, a flare should be considered.

SOLUTION:

Although Example 7 calculated a 3/4 in. inside diameter relief nozzle, a 24 in. flare stack is used. Figure A4.1 shows that the hydrogen flow rate (0.3 kg/s) and 24 in. stack diameter results in no flame dip. A 24 in. diameter flare stack would be used to get the high concentrations of air (60 to 85 volume percent) without increasing pressure drop and to limit blowout. The flare flame would still show no flame dip if this were the case.

Given: 25 percent by volume hydrogen concentration (at 0.3 kg H₂/s) the total gas flow would be the following:

$$\frac{n_{H_2}}{n_{H_2} + n_{AIR}} = 0.25; n_{AIR} = \frac{0.75}{0.25} n_{H_2}$$

vol % = mol %37

$$\therefore M_{AIR} = 0.0289 \cdot n_{AIR} = 12.9 \text{ kg / s}$$

at STP velocity at stack exit (24 in. diameter)

$$= \frac{(0.45 \text{ kg mol / s}) \cdot (2.2 \text{ lb mol / kg mol}) \cdot 359 \text{ ft}^3 / \text{lb mol}}{3.142 \text{ ft}^2} = 113 \text{ ft / s}$$

According to Figure A4.2, this velocity would result in a stable flame (no blowout); the boundary velocity gradient would be 1356 s⁻¹ using a 1 in. boundary layer thickness.

EXAMPLE 9:

Analysis of the heat leak into a LH₂ or SLH₂ transfer line and analysis of the quantity of LH₂ consumed to cool the transfer line.

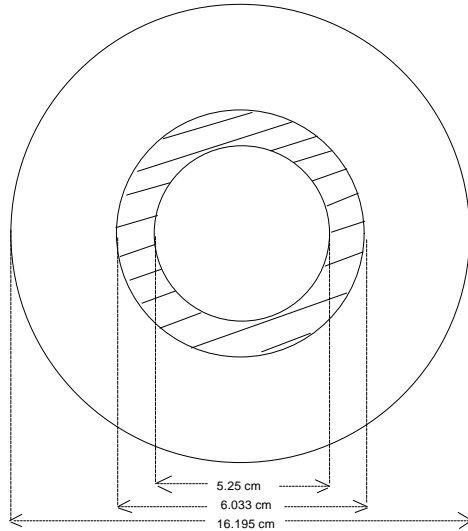

STATEMENT OF ASSESSMENT:

The introduction of LH₂ or SLH₂ into a system presents the problem of cooling the system to the appropriate temperature, 20.3 or 13.8 K. GH₂ will be flashed until the system approaches these temperatures. Too rapid introduction of the cold fluid can cause large stresses in the piping and vessels of the system.

Two calculations are of interest: 1) the total amount of LH₂ or SLH₂ needed to cool the system and 2) an estimate of the appropriate cooling rate.

Given: 10 m transfer pipe in Example 5.

$$\text{Mass steel (304L) pipe} = \frac{\rho}{4} (d_o^2 - d_i^2) L_{P304SS} = 54.24 \text{ kg}$$

$$\text{Mass insulation (85\% n Magnesia)} = \frac{\rho}{4} (d^2 - d_i^2) L_{PINSUL} = 48.06 \text{ kg}$$

The flow rate of Example 5 is

$$\frac{7.1134 \cdot 10^3 \text{ kg}}{4.3 \text{ hr} \cdot 3600 \text{ s/h}} \cdot \left(\frac{2.2 \text{ lb}}{\text{kg}} \right) \cdot \frac{1}{2 \text{ in.}} = 0.505 \frac{\text{lb}}{\text{s} \cdot \text{in.}}$$

Assume the system is to be cooled from 298 to 20.3 K.

$$\begin{aligned} C_{p\text{INSUL}} &= 0.98 \text{ kJ/kg}\cdot\text{K} \\ C_{p304\text{SS}} &= 0.461 \text{ kJ/kg}\cdot\text{K} \\ \rho_{304\text{SS}} &= 7817 \text{ kg/m}^3 \\ \rho_{\text{INSUL}} &= 271 \text{ kg/m}^3 \\ \lambda_{\text{LH}_2} &= 899 \text{ J/mol} = 446 \text{ kJ/kg} \end{aligned}$$

The total enthalpy change of the system is

$$\begin{aligned} \Delta H &= M_{304\text{SS}} C_{p304\text{SS}} \int_{T_1}^{T_2} dT + M_{\text{INSUL}} C_{p\text{INSUL}} \int_{T_1}^{T_2} dT \\ &= (54.24 * 0.461 + 48.06 * 0.98)(298 - 20.3) = 2.002 \times 10^4 \text{ kJ} \end{aligned}$$

A mass of LH₂ is required (assume phase change only). Note: This calculation would be the maximum required because it does not utilize any of the sensible heat of the GH₂ formed (Jacobs 1963).

In changing from 298 to 20.3 K, there is the possibility of a 0.3 percent contraction in stainless steel. Figure A4.5 gives the maximum flow rate to avoid too rapid cooling of pipe.

$$\text{For given pipe: } \frac{\text{wall thickness}}{\text{pipe diameter}} = \frac{0.392}{5.25} = 0.075$$

Extrapolation gives a maximum flow rate of 0.1 lb/s-in.

In Example 5, at a steady state, the flow rate was 0.5 lb/s-in.; therefore, the startup (such as the cool-down period) would need to be at a much lower flow rate (by at least a factor of 5). In addition, the 44.9 kg of LH₂ changed to GH₂ would have to be handled by the system if LH₂ is used to cool the system. This solution is for nominal pipe thickness. Consideration of the thick wall section of the piping system, such as a flange, would reduce the flow rate because thermal stresses would be greater in the thick wall section.

EXAMPLE 10:

The purging of hydrogen from systems prior to maintenance or remodeling or the purging of air from hydrogen storage vessels are important operational procedures.

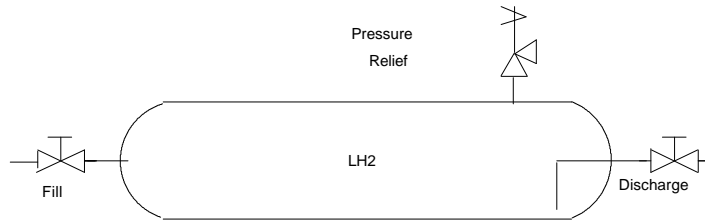

Given: 100 m³ LH₂ (plus 10 percent ullage) storage vessel.

SOLUTION:

a. Total volume : 110 m³

Assume initial volume filled with air at NTP;⁴ 293.3 K and 101.3 kPa (68 °F and 14.7 psia).

Section 701 stipulates that before filling with LH₂, the vessel should be evacuated to 1.33 kPa (0.193 psia), repressurized with helium, GN₂ or GH₂ and vented to atmospheric pressure. Venting must be done safely if GH₂ is used.

What is residual oxygen concentration?

Density air = 1.198 kg/m³

Initial moles air = (110 m³ · 1.198 kg/m³) / 28.82 kg/kg·mol = 4.57 kg·mol

Moles air after evacuation (assume ideal gas)

⁴ Normal temperature and pressure.

$$n = \frac{pV}{RT} = \frac{1.333 \text{ kPa} \cdot 110 \text{ m}^3}{\left(\frac{101.3 \text{ kPa} \cdot 22.4 \text{ m}^3}{1 \text{ kg} \cdot \text{mol} \cdot 273 \text{ K}} \right) \cdot 293.3 \text{ K}} = 0.0600 \text{ kg} \cdot \text{mol}$$

Assume vessel repressurized to 25 psig = 273.7 kPa (39.7 psia)

Total moles at pressure

$$= \frac{273.7 \text{ kPa} \cdot 110 \text{ m}^3}{\left(\frac{101.3 \text{ kPa} \cdot 22.4 \text{ m}^3}{1 \text{ kg} \cdot \text{mol} \cdot 273 \text{ K}} \right) \cdot (293 \text{ K})} = 12.36$$

∴ Total GN₂ added = 12.36 - 0.0600 kg·mol = 12.30 kg·mol

∴ Total O₂ moles = 0.0600 · 0.21 = 0.013 kg·mol

∴ Percent oxygen concentration = (0.013/12.36) · 100 = 0.1 %

It is important to remember that if LH₂ is to be stored in the vessel, oxygen and nitrogen can condense and solidify. Therefore, the use of helium as a purge gas should be considered, or GH₂ should be used to flush residual GN₂ and GOX from the vessel.

If the system is vented to atmospheric and evacuated again to 1.33 kPa (0.193 psia) after repressurization with inert gas to atmospheric, the residual oxygen is 0.000062 kg·mol or 0.0013 percent.

- b. The second method of Section 701 is to evacuate and purge with GN₂ for three cycles (omits repressurization with inert gas). Assume purge is at atmospheric pressure.

First cycle: Initial moles = 4.57 kg·mol
 Evacuate moles = 0.0600 kg·mol
 Moles oxygen = 0.013 kg·mol
 Pressure to atmospheric adds = 4.51 kg·mol GN₂

Second cycle: Evacuate moles = 0.0600 kg·mol
 Moles oxygen = 0.00017 kg·mol
 Pressure to atmospheric adds = 4.51 kg·mol GN₂

Third cycle: Evacuate moles = 0.0600 kg·mol
 Moles oxygen = 0.0000022 kg·mol
 Pressure to atmospheric adds = 4.51 kg·mol GN₂

Final percent oxygen concentration = 0.00005 %

- c. The purging of air from new tanks or GH_2 vessels for maintenance can be done using GN_2 or helium until the measured exit concentration is 25 percent of the LFL (at ambient conditions, less than one percent).

Assume the same storage system initially filled with GH_2 at 101.3 kPa and 293.3 K (68 °F and 14.7 psia).

Density GH_2 (from Table A1.1) = 0.0838 kg/m^3

Initial moles $\text{GH}_2 = (110 \text{ m}^3 \cdot 0.0838 \text{ kg/m}^3) / 2.015 \text{ kg/kg}\cdot\text{mol} = 4.57 \text{ kg}\cdot\text{mol}$

Total moles GN_2 to give 1% = $452 \text{ kg}\cdot\text{mol}$

If added to a single charge (assume constant temperature), final vessel pressure would equal

$$P_f = 101.3 \text{ kPa} (452 + 4.57) / 4.57 = 10.1 \text{ MPa} = 1470 \text{ psia}$$

If the vessel cannot contain this pressure, a continuous or semicontinuous batch-type purge must be used.

EXAMPLE 11:

The accidental leaking or release of hydrogen resulting in flammable mixtures with air presents a safety issue. The hazard analysis should address whether natural dispersion is sufficient to dissipate the mixture to below the LFL⁵ or additional operational requirements are needed.

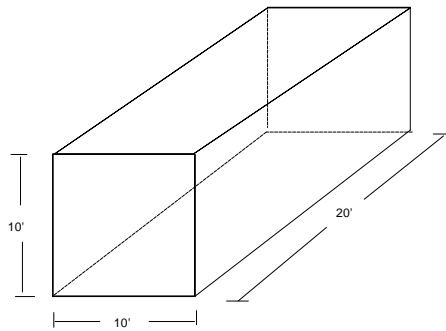

SOLUTION:

- a. Minimum standard: 400 CF at 70 °F and 14.7 psia. (Section 101b.(2))

Assume GH₂ released into 2000 ft³ laboratory space.

Given room ventilation at 2000 cfm⁶ (air turnover rate equals once per minute).

Case 1: Assume instantaneous release and mixing; therefore, initial volume concentration in the room = 20 percent GH₂

The concentration of GH₂ is equal to the following:

$$\frac{n}{RT} = \frac{14.7 \text{ psia}}{\left[\frac{(14.7 \text{ psia}) \cdot (359 \text{ ft}^3)}{1 \text{ lb} \cdot \text{mol} \cdot 492^\circ \text{R}} \right] \cdot 530^\circ \text{R}} \cdot 0.2 = 0.00052 \frac{\text{lb} \cdot \text{mol}}{\text{ft}^3} = 0.008 \frac{\text{kg} \cdot \text{mol}}{\text{m}^3}$$

⁵ Lower flammability limit.

⁶ Cubic feet per minute

Mass balance of GH₂ in room (in terms of kg·mol)

$$\frac{d}{dt} V_{\text{rm}} \cdot C = -\dot{V} C \quad (\text{Eq. B12})$$

where:

- V_{rm} = volume of room
- \dot{V} = room ventilation rate
- C = concentration of H₂
- C_0 = initial concentration of H₂

$$\ln \frac{C}{C_0} = -\frac{\dot{V}}{V_{\text{rm}}} t \quad (\text{Eq. B13})$$

$$C = C_0 \exp\left(-\frac{\dot{V}}{V_{\text{rm}}} t\right) \quad (\text{Eq. B14})$$

How long does it take to reduce room concentration to less than LFL (4 percent).

$$t = \frac{V_{\text{rm}}}{\dot{V}} \ln \frac{C}{C_0} = -\frac{2000\text{cf}}{2000\text{cfm}} \ln \frac{4}{20}$$

$$t = 1.6 \text{ min}$$

Assume air turnover rate is once every 4 min $\therefore \dot{V} = 500 \text{ cfm}$ and $t = 6.4 \text{ minutes}$. These values apply only in the case where there is no recirculation of ventilation air.

Case 2: Assuming that leaking GH₂ is instantaneously mixed with room air, what is the maximum leak rate (\dot{N}_{GH_2}) that will always result in concentrations below LFL (4%)?

Mass Balance on GH₂ (in terms of kg·mol).

$$\frac{dV_{\text{rm}} C}{dt} = \dot{N}_{\text{GH}_2} - \dot{V} C \quad (\text{Eq. B13})$$

$$\frac{V_{\text{rm}}}{\dot{V}} \frac{dC}{dt} + C = \frac{\dot{N}_{\text{GH}_2}}{\dot{V}}$$

For $V_m / \dot{V} = 1 \text{ minute @ turnover rate} + 2000 \text{ cfm}$, a solution is

$$C = \frac{\dot{N}_{GH_2}}{\dot{V}}(1 - e^{-1}) \quad (\text{Eq. B14})$$

$$\text{at } t \rightarrow \infty C = \frac{\dot{N}_{GH_2}}{\dot{V}} \quad (\text{Eq. B15})$$

$$\therefore \dot{N}_{GH_2} = 1.92 \times 10^{-3} \cdot 56.63 = 0.109 \text{ kg} \cdot \text{mol} / \text{min} \text{ or } 80 \text{ cfm of } GH_2 \quad (\text{Eq. B16})$$

$$\text{For } 0 < t < \infty C < 1.2 \times 10^{-4} \frac{\text{lb} \cdot \text{mol}}{\text{ft}^3} \left(\text{or } 1.92 \times 10^{-3} \frac{\text{kg} \cdot \text{mol}}{\text{m}^3} \right) \quad (\text{Eq. B17})$$

- b. The example above of instantaneous and complete mixing is the first of two limiting assumptions. The second limiting assumption is that the hydrogen released remains as a pure volume and at a time ($t = 0$), natural dissipation occurs to reduce the concentration of hydrogen.

Assume a spherical cloud of hydrogen 1 m in diameter at ambient conditions (298 K and 101.3 kPa).

Concentration of Hydrogen in Bubble =

$$\frac{P}{RT} = 0.041 \frac{\text{kg mol}}{\text{m}^3} = 0.003 \frac{\text{lb mol}}{\text{ft}^3} \quad (\text{Eq. B18})$$

- (1) Assuming equal-molal counter diffusion, such as when the hydrogen leaves the bubble it is replaced by air.
- (2) Assume the concentration of hydrogen at the surface of the bubble remains approximately zero, the solution can be obtained from analytical solution of diffusion problems (Carslaw and Jaeger 1959).

Concentration at the center of the bubble

$$C_C = 2C_0 \sum_{n=1}^{\infty} (-1)^n e^{-Dn^2 \pi^2 t / a^2} \quad (\text{Eq. B19})$$

where:

D = hydrogen diffusivity in air = $0.65 \text{ cm}^2/\text{s}$

t = time in seconds

a = bubble radius = 50 cm

EXAMPLE 12:

Typical material that might be included in certificate training for liquid hydrogen handlers is summarized in this example.

**LIQUID HYDROGEN HANDLER'S
QUALIFICATION TRAINING**

OVERVIEW

- BASIC POLICY
- PERSONNEL TRAINING
- PERSONNEL TRAINING MUST ADDRESS
- HYDROGEN PROPERTIES
- IGNITION SOURCES
- IGNITION PREVENTION
- HYDROGEN IN SYSTEMS
- MATERIALS TO USE IN HYDROGEN SYSTEMS
- PERSONNEL PROTECTIVE EQUIPMENT
- CRYOGENIC EXPOSURE
- GUIDELINES FOR OPERATING PROCEDURES
- TRANSFER PRECAUTIONS
- LOADING PRECAUTIONS
- EMERGENCY PROCEDURES

BASIC POLICY

- Hydrogen can be safely handled like other fuels.
 - Safety can be achieved by adherence to the following:
 - ⇒ Prevent hydrogen leaks
 - ⇒ Detect accidental leaks and take proper action
 - ⇒ Prevent hydrogen accumulation
 - ⇒ Remove likely ignition sources and suspect unknown ignition sources
-
-

PERSONNEL TRAINING

- Become familiar with hazards of hydrogen
 - Recognize human capabilities and limitations
 - Become certified for handling LH₂/GH₂
 - Understand EMERGENCY Procedures for leaks and spills
 - Adhere to accepted standards, guidelines, and codes for designing hydrogen systems
-
-

PERSONNEL TRAINING MUST ADDRESS

- Hazards of hydrogen facilities and operations
 - ⇒ Loading and storage systems
 - ⇒ Purge systems
 - ⇒ Control sampling and analytical systems
 - ⇒ Alarm/warning signal systems
 - ⇒ Ventilation requirements
 - ⇒ Fire and personnel protection
 - ⇒ System schematics and emergency procedures

HYDROGEN PROPERTIES

- Cryogenic liquids: Boiling point 20 K (-423 °F)
 - Liquid density: .07 g/cm³ (water 1 g/cm³)
 - Above 23 K (-418.6 °F), lighter than air
 - Flammability limits: Air U. 74.8% Oxygen U. 94.0%
 - L. 4.1% L. 4.1%
 - Detonation limits in Air: 18.3 - 59% hydrogen
 - Deflagration 5 to 10 Pi, Detonation ≥ 40 Pi
 - Flame temperatures (max.): 2400 K (3865 °F)
 - Hydrogen gas can increase in temperature when expanding
-
-

IGNITION SOURCES

- Electrical sparks or static electricity (breaking electrical connections, nylon clothing, etc.)
 - Friction sparks (metal on metal, stone on stone)
 - Impact sparks (sandblasting)
 - Autoignition (hot points, etc.) Temperature 584 °C (1084 °F)
-
-

IGNITION PREVENTION

- Limit sources (remove flammable items and electrical equipment from the area)
- Inert purge boxes around electrical equipment and connections
- Ground equipment
- Provide lightning protection
- Wear non-sparking clothing
- Spark proof tools

HYDROGEN IN SYSTEMS

- In LH₂ systems, vents and valves can ice up and fail
 - Hydrogen systems should be kept at a positive pressure
 - Trapped LH₂ will evaporate, pressurize and rupture lines
 - ⇒ LH₂ at 14.7 psia, heated to 70 °F, has a pressure of 28,000 psia
 - Enclosed or partially enclosed storage areas should be well ventilated
-
-

MATERIALS TO USE IN LIQUID HYDROGEN SYSTEMS

- Austenitic SS, Aluminum alloys, copper and alloys
 - Non-metals: Dacron, Teflon, Kel-F, Mylar, and Nylon
 - Effects and causes of hydrogen embrittlement
-
-

PERSONNEL PROTECTIVE EQUIPMENT

- The best single investment in safety is trained personnel
 - Eye, hand, and non-sparking clothing (face shield, gloves, and cotton coveralls)
 - Closed toe, non-porous shoes
-
-

CRYOGENIC EXPOSURE

- Cryogenic burns and injuries
 - ⇒ Remove personnel from danger area
 - ⇒ Ensure you are wearing protective equipment (also breathing air, if necessary)
 - ⇒ Call the EMERGENCY CENTER - 5111
- Asphyxiation
 - ⇒ Often occurs in inert H₂ purge environments

GUIDELINES FOR OPERATING PROCEDURES

- Provide control of hazards to an acceptable risk
 - Prevention, detection, and course of action for hydrogen leaks
 - Adequate ventilation guidelines
 - Elimination of ignition hazards
 - Outline maintenance procedures, if needed
-
-

TRANSFER PRECAUTIONS

- Transfer areas clear of non-essential personnel
 - Cancel or discontinue transfers in electrical storms
 - Discontinue transfers for leaks or fires
 - Isolate, vent, and purge H₂ lines before conducting maintenance
 - Remove sources of ignition from transfer areas
 - Work in a “buddy system”
 - Barricades, warning signs, ropes, etc. establish control
-
-

LOADING PRECAUTIONS

- Do not overload a vessel, thermal cycling of relief system
- Oxygen content in a vessel < 2%
- Ground dewar when receiving shipment
- Watch for condensed water on surfaces/leaks
- No transfers to open mouth dewars/cryopumping
- Cool down storage vessels slowly
- Examine systems for corrosion or blistering

EMERGENCY PROCEDURES

- Principle danger from a spill or leak is fire
- For H₂ fires, isolate source and let burn keeping adjacent metal components cool with water
- For a LH₂ spill, rope off area
- For a leak, isolate source, vent, purge, and repair
- If a vessel is burning near other vessels, the burning vessel may be removed if it can be done safely
- Do NOT flare leaks deliberately
- If annulus is exposed to air, do NOT cool with water
- If a LH₂ vessel overturns, try venting through a liquid outlet if this will allow the ullage to vent

REFERENCES

- Gordon, S. and B. J. McBride. *Computer Program for Calculation of Complex Chemical Equilibrium Compositions and Applications*. NASA Reference Publication 1311, October (1994).
- Lewis, G. N., and M. Randall. *Thermodynamics*. Revised by K. S. Pitzer and L Brewer, McGraw-Hill Book Co., Inc., New York (1961).
- Ludwig, E. E., "Applied Process Design for Chemical and Petrochemical Plants" and the values of C and K are from this source.
- Jacobs, R. B. *Liquid Requirements for the Cooldown of Cryogenic Equipment*. Advances in Cryogenic Engineering, Vol. 8, (1963): pp. 529-535.
- McCarty, R. D., J. Hord, and H. M. Roder. *Selected Properties of Hydrogen (Engineering Design Data)*. NBS Monograph 168, National Bureau of Standards, Boulder, CO (1981).
- Geankoplis, C. J. *Transport Process and Limit Operations*. 2nd Edition, Prentice Hall, Englewood Cliffs, NJ, 1983, pg. 218-219.
- Stewart, W. and F. C. Prenger. *Thermal Insulation Options for the Superconducting Transmission Initiative Project*. Los Alamos National Laboratory, LA-UR-91-850, Los Alamos, NM (1991).

APPENDIX C

SCALING LAWS, EXPLOSIONS, BLAST EFFECTS, AND FRAGMENTATION

C.1 SCALING LAWS

A comprehensive review of accidental explosions has been made by Strehlow and Baker (1975). The review characterizes explosions by type, discusses the various scaling laws, and summarizes nonideal blast wave behavior and the mechanisms by which blast waves produce damage (Stull 1977; DoD 6055.9 1992).

- a. High explosives or nuclear weapons mainly have been used to produce the waves in the classical experimental work on blast waves. The intermediate- and far-field waves generally, quite closely resemble the waves predicted from point-source theory, and to this extent high explosives or nuclear explosions can be considered ideal.
- b. A point-source blast wave is a blast wave conceptually produced by the instantaneous deposition of a fixed quantity of energy at an infinitesimal point in a uniform atmosphere. Essentially there are three regions of interest as a point-source wave propagates away from its source:
 1. The near-field wave in which pressures are so large external pressure (or counter-pressure) can be neglected
 2. An intermediate region of extreme practical importance because the overpressure and impulse are sufficiently high to do significant damage
 3. A far-field region that yields to an analytic approximation such that the positive overpressure portion of the curve for large distances can easily be constructed from the overpressure-time curve at one far-field position
- c. Scaling the properties of point-source blast waves is common practice and subject to cube-root scaling (Sach's law). A given pressure theoretically will occur at a distance from an explosion proportional to the cube root of the energy yield. Full-scale tests have shown this relationship between distance and energy yield to hold over a wide range of explosive weights. According to Sach's law, if d_1 is the distance from a reference explosion of a mass of W_1 at which a specified hydrostatic overpressure or dynamic pressure is found, for

any explosion of a mass of W , these same pressures will occur at a distance d given by Equation C1:

$$\frac{d}{d_1} = \left(\frac{W}{W_1} \right)^{1/3} \quad (\text{Eq. C1})$$

Plots of overpressures for various explosive weights consequently can be superimposed on the curve for 0.45 kg (1 lb) of explosive if, instead of distance, the distance divided by the cube root of the weight is plotted against overpressure. This correlating parameter $(d/W)^{1/3}$, called scaled distance, is used to simplify the presentation of the blast wave characteristics.

- d. Cube-root scaling also can be applied to arrival time of the shock front, positive-phase duration, and impulse. The distances concerned also are scaled according to the cube-root law. The relationships can be expressed in the forms $t/t_1 = d/d_1 = (W/W_1)^{1/3}$ and $I/I_1 = d/d_1 = (W/W_1)^{1/3}$, where t_1 represents arrival time or positive-phase duration and I_1 is the impulse for the reference explosion W_1 ; as before, d_1 and d are distances from ground zero. If W_1 is taken as 0.45 kg (1 lb), the various quantities are related as $t = t_1 W^{1/3}$ at a distance $d = d_1 W^{1/3}$ and $I = I_1 W^{1/3}$ at a distance $d = d_1 W^{1/3}$.
- e. No general laws exist for scaling blast waves from nonideal explosions because not all the physical parameters affecting such explosions are known. The general concept of equivalence for a nonideal explosion is not well understood. The near-field overpressures usually are much lower than those of a point-source explosion that produces the equivalent far-field overpressure, but it is not obvious exactly what the relationship between near- and far-field behavior should be or how this relationship differs with the type of accidental explosion. It is also not obvious how to evaluate the blast damage of any particular type of accidental explosion or how much the damage depends on the type of explosion.
- f. The comparison between ideal and accidental explosions is inexact because propellant explosions are not considered point sources. The concept of TNT equivalence, widely used in safety studies, is also very inexact and may be quite misleading. Scaling laws for nonideal explosions are not known exactly, but they can be easily developed after the physics of such explosions is well known. The scaling laws likely will be variants on Sach's law (Strehlow and Baker 1975; CPIA 1984).
- g. Theoretical work suggests that distances at which the pressure levels are over approximately 101.3 kPa (14.7 psi) for liquid oxygen (LOX)-liquid hydrogen (LH₂) explosions, the TNT equivalent in terms of peak pressure is about 0.07. The TNT equivalent is about 1

for pressure levels from 101.3 to 0.7 kPa (14.7 to 0.1 psi); and it is about 2.0 below 0.7 kPa (0.1 psi).

- h. These numbers mean that to generate the same pressure-distance relationship as 0.45 kg (1 lb) of TNT at 101.3 kPa (14.7 psi) and above it takes about 6.5 kg (14.3 lb) of LH₂ and LOX; from 101.3 to 0.7 kPa (14.7 to 0.1 psi), about 0.45 kg (1 lb); and at less than 6.9 kPa (0.1 psi) only 0.23 kg (1/2 lb). Correlation with damaging effects on buildings, vehicles, humans, etc., can be made from existing methods and data in the literature if blast wave characteristics can be defined for accidental explosions (CPIA 1984; Baker et al. 1978; AMCP-706-180 1972). Fragmentation patterns from accidental explosions and the damaging effects of these fragments are quite difficult to predict.

C.2 TYPES OF EXPLOSIONS

a. Explosions In Buildings.

- (1) Explosions in buildings are of three main types, increasing in severity from type a to type c:
 - (a) a spill of some combustible material and a slow deflagration wave or flashback fire causes a relatively slow buildup of pressure in the building
 - (b) a piece of equipment explodes and produces a blast wave inside the building that damages the structure or is relieved by venting
 - (c) a leak occurs, but the combustible mixture that forms detonates.
- (2) The degree of confinement or the bursting pressure of the vessel or building, for the first and second types of explosion, determines the nature of the blast wave generated and damage patterns. The blast wave behavior and damage patterns in a detonative combustion (third type) primarily are determined by the behavior of the detonation and are only modified by the confinement.

b. Tank Ruptures.

- (1) A rupture followed by combustion is a very special type of explosion that primarily occurs when a tank of liquefied fuel, under pressure, is heated by an external fire, following an

accident, until the tank vents and torches. The heating of the venting tank needs to be sufficiently intense to cause the internal pressure to rise above the bursting pressure of the tank for an explosion to occur, even with venting. This type of explosion has three distinct damage-producing effects:

- (a) A blast wave because of internal pressure relief
 - (b) A fireball caused by subsequent massive burning of the tank's contents in air
 - (c) Large fragments scattered for long distances because of the ductile nature of the rupture of the tank and rocketing of pieces by reaction forces
- (2) Recent studies show that no single TNT equivalent can be used to describe the blast generated by a rupturing pressure vessel. The tank-rupture blast pressures, combined with the positive shock wave durations, yield positive values of shock wave impulse with a impulse-distance relationship similar in slope to that for TNT. Impulses for tank rupture and the TNT equivalent are not significantly different quantitatively for large, high-pressure vessels.
- (3) A general comparison of blast and fragment parameters generated by tank rupture and an equivalent TNT charge shows that side-on pressures are higher for TNT above 69 to 41 kPa (10 to 6 psi) and lower for TNT at pressures below these values. Face-on tank pressures show a similar relationship to face-on TNT pressures. Positive shock wave durations are longer for tank rupture than for TNT. Impulse, face-on and side-on, are similar for TNT and tank rupture. Damage, depending on distance, may be greater for tank rupture. Tank-rupture fragments are larger than would be expected from a cased TNT charge. Fragment velocities are higher for a cased TNT charge than for tank rupture (Baker et al. 1974 and 1978).

c. Vapor Cloud Explosions.

1. The visual sequence of events in a vapor cloud explosion follows:
 - a) A massive release of a combustible fuel
 - b) A reasonable delay in ignition, 30 s to 30 min
 - c) Ignition of the cloud resulting in an explosion

2. Vapor cloud ignition can lead to two very different types of behavior relative to the blast wave produced and leads to the conclusion that detonative combustion needs to always occur before a destructive blast wave is produced.
 3. Studies using the usual atmospheric dispersion equations have shown that the maximum fraction of the fuel that would be in the combustible range at any one time from a continuous or massive spill would be about 10 percent. This agrees quite satisfactorily with available data, in which the maximum yield based on TNT equivalent weight is about 10 percent (Baker et al. 1974; Strehlow, Savage and Vance 1972). Current research into the behavior of vapor cloud explosions is of two major types:
 - a) Assessing the behavior of a deflagrative explosion of the cloud
 - b) Assessing the area of cloud dispersion
 4. The blast waves produced by the explosion of liquid propellants accidentally mixed generally are quite unreproducible and difficult to adequately model. Extensive studies of liquid propellant explosions show that the explosions differ from TNT explosions in a number of ways, so the concept of TNT equivalence quoted in pounds of TNT is far from exact.
- d. Ground-Handling System Explosions.
- (1) The hazards from accidental explosions in propellant ground-handling systems are similar in many respects to the hazards from such explosions in flight vehicles. The accidents cause damage by air-blast loading, fragment or appurtenance impact, radiation from fireballs, or fire from the ignition of combustible materials after an explosion (Strehlow and Baker 1975; DoD 6055.9 (1992); CPIA PUB. 394 (1984); AMCP-706-180 (1972); Strehlow, Savage, and Vance 1972).
 - (2) Flight and ground systems can fail by material fatigue caused by overstressing. Many possible causes of flight vehicle explosions; such as loss of thrust during launch, guidance system failure, or rupture of a bulkhead separating a fuel from an oxidizer; are inapplicable for ground-handling systems.

- (3) The nature of the hazards is different because ground-handling systems have fewer weight constraints than flight vehicles. The total energy stored in compressed gases or the total chemical energy stored in fuels and oxidants also can be much greater than for many flight systems.
- (4) Many more accidental explosions involving fuels and compressed fluids have occurred in ground-handling systems than in flight vehicles, including the following:
 - (a) Simple pressure vessel failure caused by fatigue or flaw growth
 - (b) Vessel failure induced by impact during a transportation accident
 - (c) Vessel failure by overpressure caused by overheating
 - (d) Vessel and pipeline failure caused by overpressure, corrosion or erosion
 - (e) Fuel leakage followed by a vapor cloud explosion.
- (5) *Workbook for Estimating Effects of Accidental Explosions in Propellant Ground Handling and Transport Systems* (Baker et al. 1978) and *Assembly and Analysis of Fragmentation Data for Liquid Propellant Vessels* (Baker et al. 1974) provide methods for predicting blast and fragment characteristics and effects for a wide range of possible explosion accidents in ground and flight systems. The material allows for the prediction of the following:
 - (a) Explosive energy yield or energy release
 - (b) Characteristics of blast pressure waves generated by spherical and nonspherical explosions
 - (c) Effects of pressure waves on certain classes of targets
 - (d) Characteristics of fragments generated by ground equipment explosions, including massive vessel parts that rocket
 - (e) Effects of fragment impact, including effects of fragment revetments on blast waves

Various safety factors are included in the prediction methods.

C.3 CHARACTERISTICS OF FRAGMENTS

- a. Accidental explosions in ground systems tend to produce very different types of fragments or missiles than similar explosions in flight-weight systems. The most striking difference lies in the number of fragments generated, usually much fewer for ground systems than flight systems.
- b. *Workbook for Estimating Effects of Accidental Explosions in Propellant Ground Handling and Transport Systems* (Baker et al. 1978) develops methods of predicting velocities and ranges of fragments from bursting vessels. The fragment range information is based on data from various explosion sources.
- c. The fragment range and mass distributions for the various explosion sources are also included in the references.

C.4 EFFECTS OF BARRICADES ON BLAST WAVES

- a. Barricades are constructed near potential explosion sources or in front of structures and facilities located near potential explosion sources. They are intended to be protective devices to arrest fragments or attenuate blast waves. Results of analyses and tests show the following:
 - (1) Barricades reduce peak pressures and impulses behind the barricades.
 - (2) Single-revetted barricades are more efficient in reducing peak pressures and impulses than mounds.
 - (3) Values of peak pressure and impulse are greatly influenced by the height above the ground, location of the barricade, and barricade dimensions and configuration.
- b. The effects of near-field, single-revetted barricades on peak overpressures and side-on impulses are given in *Workbook for Estimating Effects of Accidental Explosions in Propellant Ground Handling and Transport Systems* (Baker et al. 1978) and *Principles of Explosive Behavior* (AMCP-706-180 (1972)). The references also contain curves indicating blast pressures for predicting lung damage and lethality.

C.5 ESTIMATES OF EXPLOSIVE YIELDS FROM COMPRESSED GAS BURSTS

a. Compressed Gas Bursts.

The various formulas for total energy release are reviewed. These include Equation C2:

$$E = \left(\frac{P_i - P_a}{g_1 - 1} \right) V_i \quad (\text{Eq. C2})$$

where

- E = blast yield (energy)
- P_i = the initial absolute pressure in the vessel
- P_a = the absolute pressure of the outside atmosphere
- g_1 = the ratio of specific heats for the gas in the vessel
- V_i = the initial volume

An estimate based on isentropic expansion from initial burst pressure to atmospheric pressure and

$$E = \frac{P_i V_i}{\gamma_1 - 1} \left[1 - \left(\frac{P_a}{P_i} \right)^{(\gamma_1 - 1)/\gamma_1} \right] \quad (\text{Eq. C3})$$

as a lower limit, the energy released by constant pressure addition to the explosion source region

$$E = P_a (V_f - V_i) \quad (\text{Eq. C4})$$

where V_f = the final volume occupied by the gas originally in the vessel.

- b. The three equations are given in descending order of total blast energy. The blast yield is considered to lie between equations C3 and C4. Equation C2 gives slightly higher values than does equation C3, but both are considered to yield overestimates and are very conservative.
- c. The equations given for blast yields are based on the assumption that all the energy that can drive a blast wave does so depending only on the energy release rate. Some energy for real vessels needs to be absorbed by the vessel as it fractures; in the fracturing process itself and accelerating the vessel fragments to their maximum velocity.
- d. *Workbook for Estimating Effects of Accidental Explosions in Propellant Ground Handling and Transport Systems* (Baker et al. 1978) provides methods for estimating the velocity and kinetic

energy of the vessel fragments. Also, the workbook reviews the characteristics of blast waves from liquid propellant explosions and spherical gas vessel bursts and their similarities to the differences from waves from condensed high explosives such as TNT.

- e. All blast parameters are plotted as nondimensional and are shown as functions (f_i) of two nondimensional variables P_1/P_a and \bar{R} ,

$$\text{where } \bar{R} = \frac{RP_a^{1/3}}{E^{1/3}} \text{ and } f_i \text{ is } f_i \left(\frac{P_1}{P_a}, \bar{R} \right).$$

Values of the following properties can be calculated from the scaled curves:

$$\bar{P}_s = \frac{P_s}{P_a}$$

$$\bar{t}_a = \frac{t_a P_a^{1/3}}{E^{1/3}}$$

(Eq. C5)

$$T = \frac{T a_a P_a^{1/3}}{E^{1/3}}$$

$$T_s = \frac{I_s a_a}{P_a^{2/3} E^{1/3}}$$

where

- P_a = ambient pressure (absolute)
- a_a = ambient sound velocity
- P_s = peak static (side-on) overpressure
- t_a = arrival time of peak overpressure
- T = duration of overpressure
- I_s = specific impulse
- R = radius of blast wave (standoff distance)
- P_i = internal absolute pressure of sphere

- f. Typical blast pressure histories for a burst of a frangible gas sphere are given in Baker et al. (1974) and Adamczyk and Strehlow (1977). Characteristics are a pronounced negative phase compared to the first positive phase and the strong second shock wave. By contrast, waves from condensed explosives show much smaller negative phases and seldom have a discernible second shock.

- g. Peak overpressures and shock wave impulse values from a 55 MPa gage (8000 psig) and a 4.1 MPa gage (600 psig) tank rupture are given in Adamczyk and Strehlow (1977) and Strehlow and Ricker (1976). The term “strength,” used in these references, refers to several characteristics of a blast wave that relate to the potential of the wave to cause damage and is defined as follows:
- (1) Peak overpressure. The static pressure (often called side-on pressure) is greatest at the wave front. This is the peak overpressure, generally reported as pounds/square inch above atmospheric pressure.
 - (2) Duration. After the wave front passes, the static pressure falls to slightly below atmospheric. The duration of the positive phase - the time required to drop the peak overpressure to atmospheric pressure - is of greatest significance in causing damage.
 - (3) Blast-wind velocity. Behind the front of the blast wave the air moves at considerable speed in the same direction as the wave. A peak overpressure of 34.5 kPa (5 psi) will be accompanied by a 72 m/s (236 ft/s) wind for example.
 - (4) Dynamic overpressure. The pressure rise produced when the blast wind is brought to rest is called the dynamic overpressure.
 - (5) Peak reflected overpressure. The airflow will be stopped and a shock wave will reflect backward from the surface if a blast wave strikes a surface (such as a wall) at normal incidence. Behind the reflected shock the surface briefly will be subjected to the peak reflected overpressure; sometimes called the face-on overpressure. It is considerably larger than the stagnation overpressure; the sum of the peak and dynamic overpressures.
 - (6) Positive overpressure impulse. The area under the positive phase of the overpressure time curve at or near the reflecting surface.

C.6 DEGREES OF HAZARD

- a. Hazards with hydrogen may vary depending on the specific location. The hazards are most severe at the range launch pads. The proximity of hydrogen and oxidizers, launchings, nearby facilities, lift-off problems, and possibilities of fallback make these operations most hazardous. The liquid propellant explosive equivalent recommended

is 60 percent; however, the percentage factors should be reduced when the propellants are unconfined (CPIA PUB. 394 1984; DoD 6055.9 1992; Baker et al. 1978;).

- b. Hazards at static test stands, where heavier tankage and greater controls are used, are lower than those at launch pads. Large storage facilities are not normally involved in feeding the engine during tests. Also, facility design should limit any mixing of propellants, reducing the hazard potential.
- c. Cold-flow test operations in which the fuel and oxidizer have completely separate, isolated systems are governed by fire and fragment hazards.
- d. Bulk and temporary storage facilities not directly connected to the launch and test operations are the least hazardous. Pipelines used for transferring propellants should be at least 15.2 m (50 ft) from any inhabited buildings (either side of pipeline).

C.7 ADDITIONAL GUIDELINES

- a. Additional guidelines for estimating explosion damage and designs for limiting explosion damage are presented in *Design for Limiting Explosion Damage* (Lawrence and Johnson 1974); *Guidelines for Estimating Damage Explosion* (Brasie and Simpson 1968); *Structures to Resist the Effects of Accidental Explosions* (Department of the Army TM5-1300; and *Analysis of Hydrogen Explosion Hazards* (Porter 1982).
- b. The thermophysical properties of hydrogen are summarized in *Selected Properties of Hydrogen* (McCarty, Hord, and Roder 1981).

C.8 REFERENCES

- Adamczyk, A. A., and R. A. Strehlow. *Terminal Energy Distribution of Blast Waves from Bursting Spheres*. NASA CR-2903 (1973).
- Air Force, Army, and Navy. *Structures to Resist the Effects of Accidental Explosions*. Department of the Army Technical Manual TM5-1300, Department of the Navy Publication NAVFACP-397, Department of the Air Force Manual ARM 88-22 (June 1969).
- AMCP-706-180. *Engineering Design Handbook, Principles of Explosive Behavior*. Army Materiel Command, Alexandria, VA, April (1972).
- Baker, W. E., J. J. Julesz, R. F. Ricker, P. S. Westine, V. B. Parr, I. M. Vargas, and P. K. Moseley. *Workbook for Estimating Effects of Accidental Explosions in Propellant Ground Handling and Transport Systems*. NASA CR-3023, NASA (1978).
- Baker, W. E., V. Parr, R. Beesey, and D. Cox. *Assembly and Analysis of Fragmentation Data for Liquid Propellant Vessels*. 74N1562, NASA CR-134538, NASA (1974).
- Brasie, W. C., and D. W. Simpson. "Guidelines for Estimating Damage Explosion." *Loss Prevention*, Vol. 2, AIChE, (1968): pp. 91-102.
- CPIA. "Hazards of Chemical Rockets and Propellants Vol. I, II, and III." Publication 394, *Chemical Propellant Information Agency*, The Johns Hopkins University, Applied Physics Laboratory, Laurel, MD (September 1984).
- DoD 6055.9. *Ammunition and Explosives Safety Standards*. Department of Defense, July 1992.
- Lawrence, W. E., and E. E. Johnson. "Design for Limiting Explosion Damage." *Chemical Engineering*, Vol. 81, No. 1 (January 7, 1974): pp. 96-104.
- McCarty, R. D., J. Hord, and H. M. Roder. *Selected Properties of Hydrogen*. NBS-MN-168, National Bureau of Standards (February 1981).
- Porter, J. B. *Analysis of Hydrogen Explosion Hazards*. DP-1295, E. I. DuPont DeNemours, Aiken, SC (July 1982).
- Strehlow, R. A., and W. E. Baker. *The Characterization and Evaluation of Accidental Explosions*. UILU-ENG-75-0503, NASA Grant NSG-30080, NASA CR-134779, Illinois University, Champaign/Urbana, IL (1975).
- Strehlow, R. A., and R. E. Ricker. "The Blast Wave from a Bursting Sphere." *Loss Prevention*, Vol. 10 (1976): pp. 115-121.

Strehlow, R. A., L. D. Savage, and G. M. Vance. *On Measurement of Energy Release Rates in Vapor Cloud Explosions*. UIIU-ENG-72-1503, University of Illinois, Champaign/Urbana, IL, August (1972).

Stull, D. R. "Fundamentals of Fire and Explosion." AICHE Monograph Series, Vol. 73, No. 10 (1977).

APPENDIX D

CODES, STANDARDS AND NASA DIRECTIVES

D.1 GENERAL

- a. Appendix D gives a brief description and scope of the codes, standards, and NASA directives applicable for hydrogen systems.
- b. Standards, such as the ASME Boiler and Pressure Vessel Code (BPVC) (1995) and NFPA 50B (1994), are not mandatory by themselves, but mandatory compliance with various standards can be mandated by federal, state, or local governments, or by NASA directives.
- c. Federal regulations applying to hydrogen are embodied primarily in 49 CFR (1995) and 29 CFR (1996), DOT and OSHA, respectively. The DOT portions apply to the transportation of hydrogen, and the OSHA portion applies to its safe handling in the work place. The DOT classifies and treats gaseous and liquefied hydrogen as a compressed, flammable gas. Hydrogen is classified as a hazardous material in 29 CFR (1996).
- d. Hydrogen storage is separated into two categories in this guideline: nonpropellant and propellant use.
 - (1) The nonpropellant category involves the storage of GH₂ and LH₂ in which the main safety consideration is release and possible burning of H₂ in air. (Section D.4)
 - (2) The propellant category involves the storage and use of LH₂ in an experimental or test facility or launch complex as a propellant in conjunction with an oxidizer (such as liquid oxygen (LOX)), for which the primary safety consideration is pressure rupture and/or the rapid combustion, or detonation, of a hydrogen-oxidizer mixture. (Section D.5)
- e. There are no NFPA standards specifically for hydrogen pressure piping as defined in Section D.3c.(4); however, the Compressed Gas Association has a standard for piping systems described in Section D.3d (CGA G-5.4 1992).
- f. The American National Standards Institute (ANSI) is the administrator and coordinator of the United States private sector voluntary standardization system. ANSI does not itself develop American National Standards (ANS); rather, it facilitates development by

establishing consensus among qualified groups. The American Society of Mechanical Engineers (ASME), and an ANSI document often have the same designation. The designation for the ANS on Power Piping can be listed several ways that include ANSI B31.1, ASME B31.1, and ANSI/ASME B31.1. ANSI/ASME B31.1 is the newer, most proper designation for this standard. A standard developed by an organization such as ASME does not receive an ANSI designation until it has been approved as an ANS.

D.2 ASME BOILER AND PRESSURE VESSEL CODE

The ASME BPVC (1986) establishes rules of safety governing the design, fabrication, and inspection of boilers and pressure vessels and nuclear power plant components during construction. The objective of the rules is to assure reasonably certain protection of life and property and provide a margin for deterioration in service. Advancements in design and material and the evidence of experience are constantly being added by Addenda. The BPVC (1996) is organized in the following sections:

- I Power Boilers
- II Materials
 - Part A - Ferrous Material Specifications
 - Part B - Nonferrous Material Specifications
 - Part C - Specifications for Welding Rods, Electrodes and Filler Metals
 - Part D - Properties
- III Rules for Construction of Nuclear Power Plant Components
- IV Heating Boilers
- V Nondestructive Examination
- VI Recommended Rules for the Care and Operation of Heating Boilers
- VII Recommended Guidelines for the Care of Power Boilers
- VIII Pressure Vessels
 - Division 1
 - Division 2, Alternative Rules
- IX Welding and Brazing Qualifications
- X Fiber-Reinforced Plastic Pressure Vessels
- XI Rules for Inservice Inspection of Nuclear Power Plant Components

Section VIII, Division 1 of the BPVC (1996) is commonly specified for the design, fabrication, and testing of storage vessels, GH_2 and LH_2 . Section IX of the BPVC (1996) is commonly specified for welding.

D.3 CODES AND STANDARDS FOR PRESSURE PIPING

a. General.

- (1) ASME B31, Code for Pressure Piping, sets engineering requirements deemed necessary for the safe design and construction of pressure piping systems. ASME B31 contains basic reference data and formulas necessary for design of pressure piping. It contains prohibitions in areas practices or designs are known to be unsafe. The Code contains warnings or “flags” when caution is known to be necessary, but it is felt that a direct prohibition would be unwise. The Code consists of the following sections:

- A13.1 Scheme for the Identification of Piping Systems
- B31G Manual for Determining the Remaining Strength of Corroded Pipelines: A Supplement to B31, Code for Pressure Piping
- B31.1 Power Piping
- B31.2 Fuel Gas Piping
- B31.3 Process Piping (formerly Chemical Plant and Petroleum Refinery Piping)
- B31.4 Liquid Transportation Systems for Hydrocarbons, Liquid Petroleum Gas, Anhydrous Ammonia, and Alcohols
- B31.5 Refrigeration Piping
- B31.8 Gas Transmission and Distribution Piping Systems
- B31.9 Building Services Piping
- B31.11 Slurry Transportation Piping Systems

Sections A13.1, B31.1, and B31.3 of ASME B31 are the most applicable to hydrogen systems.

- (2) The development of a code for cryogenic piping (ANSI B31.10) was started, but never completed. Cryogenic piping was incorporated into B31.3 rather than having a separate code specifically for cryogenic piping.
- (3) The following specifications are made with regard to the piping associated with a GH₂ storage system:

- NFPA 50A - ASME B31.3, Chemical Plant and Petroleum Refinery Piping
- 29 CFR 1910.103 - ANSI B31.1-1967 with addenda B31.1-1969, Industrial Gas and Air Piping, Pressure Piping Section 2

- (4) The following specifications are made with regard to the piping associated with an LH₂ storage vessel:

- NFPA 50B - ANSI B31.3, Chemical Plant and Petroleum Refinery Piping, with materials meeting requirements of Chapter III for piping at an operating temperature below 244 K (-20 °F)
- 29 CFR 1910.103 - ANSI B31.1-1967 with addenda B31.1-1969, Industrial Gas and Air Piping, Pressure Piping Section 2, for GH₂ piping at an operating temperature above 244 K (-20 °F)
- ANSI B31.3-1966, Petroleum Refinery Piping or ANSI B31.5-1966 with addenda B31.5a-1968, Refrigeration Piping, for GH₂ piping at an operating temperature below 244 K (-20 °F), and for LH₂ piping

b. ASME B31.1, Power Piping.

- (1) ASME B31.1 (1995) prescribes minimum requirements for the design, materials, fabrication, erection, test, and inspection of power and auxiliary service piping systems for electrical generation stations, industrial and institutional plants, central and district heating plants, and district heating systems except as limited by the Code. This code covers boiler external piping as defined in the Code for power boilers and high-temperature, high-pressure water boilers.
- (2) Power piping systems covered by this Code apply to all piping and their component parts within or forming a part of the above-mentioned plants except as excluded in the Code. They include but are not limited to steam, water, oil, gas, and air services.
- (3) This Code does not apply to the following: piping specifically covered by other Sections of ASME B31 such as fuel gas piping; pressure vessels covered by the BPVC; building heating and distribution steam piping (low pressure); roof and floor drains, plumbing, sewers, and sprinkler and other fire protection systems; piping for hydraulic or pneumatic tools and their components; piping for marine or other installations under Federal control; piping for nuclear installations covered by the BPVC (1986); and building services piping.

- (4) Piping as used in this Code includes pipe, flanges, bolting, gaskets, valves, relief devices, fittings, and pressure containing portions of other piping components. It also includes hangers and supports and other equipment necessary to prevent overstressing the pressure containing components.

- c. ASME B31.3, Process Piping (formerly, “Chemical Plant and Petroleum Refinery Piping”).
- (1) ASME B31.3 (1996) prescribes minimum requirements for the design, materials, fabrication, erection, test, and inspection of pressure piping systems for a variety of applications, including cryogenic plants, petroleum refineries, chemical plants, and related processing plants and terminals.
 - (2) ASME B31.3 (1996) does not cover the piping associated with a pressure vessel covered by the ASME BPVC (1995). Piping associated with a pressure vessel is covered by the ASME BPVC (1995), NFPA 50A (1994), NFPA 50B (1994), and 29 CFR 1910.103 (1996) for hydrogen. Certain piping within a facility may be subject to other codes and standards, including but not limited to the following: piping for fuel gas from the point of delivery to the connection of each fuel utilization device; fire protection systems using water, carbon dioxide, Halon, foam, dry and wet chemicals; medical and laboratory gas systems; potable hot and cold water; and sewer and drain systems.
 - (3) Piping as used in this guideline includes pipe, tubing, flanges, bolting, gaskets, valves, relief devices, fittings, and the pressure containing portions of other piping components. It also includes hangers and supports and other equipment necessary to prevent overstressing pressure containing components.
 - (4) Piping is considered as the piping that begins when a pressure vessel proper terminates at the following:
 - (a) The first circumferential joint for welding end connections
 - (b) The face of the first flange in bolted flanged connections
 - (c) The first threaded joint in that type of connection and that extends up to and includes the valve or valves on the pressure vessel as required by the ASME BPVC (1986).
 - (5) ASME B31.3 (1996) generally does not specify specific materials to be used in piping systems, but provides guidance and limitations on the selection of some materials acceptable for use in piping systems. The Code provides some useful properties for these materials, such as minimum temperature,

and maximum allowable stress values as a function of operating temperature (see summary in Table A5.3).

- d. A standard specifically for hydrogen piping systems is the Compressed Gas Association's "Standard for Hydrogen Piping Systems at Consumer Locations," CGA G-5.4 (1992). This CGA standard describes the specifications and general principles recommended for piping systems for gaseous or liquid hydrogen on premises beginning at the point at which hydrogen enters the distribution piping (the battery limits of the hydrogen storage system) at service pressure to the use point of the hydrogen. The information in CGA G-5.4 (1992) is general in nature and intended for use by designers, fabricators, installers, users, and maintainers of hydrogen piping systems and should be of interest to safety personnel, fire departments, building inspectors, and other emergency personnel. CGA G-5.4 (1992) specifies piping systems should be designed in accordance with ASME B31.3, "Chemical Plant and Petroleum Refinery Piping."

D.4 STANDARDS AND REGULATIONS FOR THE COMMERCIAL, INDUSTRIAL, AND NONPROPELLANT USE OF HYDROGEN

a. General.

- (1) NFPA 50A (1994) and NFPA 50B (1994) have a narrow scope of application. They cover bulk storage vessels from the point of fill connection to the point at which hydrogen enters the distribution piping. They do not cover the delivery vehicle or the distribution piping. The quantity-distance (QD) requirements are key features of the two standards.
- (2) QDs are based on the concept that the effects of fire, explosion, and detonation can be reduced to tolerable levels if the source of the hazard is kept far enough from people and other facilities. Having a separation distance between a hydrogen system and people and other equipment reduces confinement, which provides a greater probability that hydrogen from leaks or spills will diffuse and dissipate without contacting an ignition source. A separation distance also provides flame-propagation control; thermal radiation from a fire does not create a situation in which fire from one source is propagated to another combustible material.
- (3) NFPA 50A (1994) and NFPA 50B (1994) were developed from tested and proven industrial handling and storage techniques for

the practical needs of a commercial operation. (One of the activities of the NFPA is the development of codes and standards to enhance fire safety.) Guidelines of the DoD and NASA, such as DoD 6055.9 (1992) and NSS 1740.12 (1993), primarily established for explosives and propellants for missile and rocket applications, were considered in the formulation of the NFPA standards for industrial applications. The QD guidelines of the DoD and NASA were considered unrealistically severe and did not apply to conventional industrial users. The NFPA standards were developed on a concept based on the maximum credible accidental leakage or spill that could be expected in a given installation. Spills of 18.9 to 189L (5 to 50 gal) could be expected and would be within the parameters of the standard in servicing a typical 26,500 L (7000 gal) LH₂ customer station using loading and handling techniques developed by commercial companies for example. It was felt that this “reasonable scope of expectation,” based on experience, should be recognized as the safety parameter rather than a major catastrophe, such as a falling airplane. The safety philosophy of the standard, initially developed as a CGA standard then later as a NFPA standard, may be simply expressed as follows: protect the system from the user, not just the user from the system. The NFPA standard specifications for construction, installation, distance locations, and materials were established to limit hazards so severe damage to surrounding buildings and personnel would be highly unlikely. (Connolly 1967)

- (4) NFPA 50A (1994) and NFPA 50B (1994) do not specify whether the QD guidelines are determined by the hydrogen system exposing the adjacent occupancy, the adjacent occupancy exposing the hydrogen installation, or a mutual exposure. A difference in the hazards between the “business” end of a storage vessel and the “nonbusiness” end of a storage vessel is possible. The business end contains the vessel connections, vaporizers, and other equipment. NFPA 50B (1994) addresses the difference by setting different distances for “insulated” versus “noninsulated” portions of the storage vessel; however, the distances in NFPA 50A (1994) do not currently reflect any difference in the hazard between the two ends.¹
- (5) The QD guidelines of NFPA 50B (1994) are predicated on the installation of an emergency vent system sized to prevent a storage vessel rupture even when the vessel is surrounded by fire (NASA TM 104438 1992).

¹ Bender, F. X. Presentation notes on discussion of NFPA 50A and NFPA 50B.

b. NFPA 50A, Gaseous Hydrogen Systems at Consumer Sites.

- (1) NFPA 50A (1994) covers the requirements for the installation of GH₂ systems on consumer premises that meet the following criteria:
 - (a) The hydrogen supply to the consumer premises originates outside the consumer premises.
 - (b) The hydrogen supply is delivered by mobile equipment.
- (2) This standard does not apply to single systems using containers having a total hydrogen content of less than 11 CM (400 CF). However, this standard applies to individual systems, each having a total hydrogen content of less than 11 CM (400 CF) located less than 1.5 m (5 ft) from each other.
- (3) This standard does not apply to hydrogen manufacturing plants or other establishments operated by a hydrogen supplier or the supplier's agent for the purpose of storing hydrogen and refilling portable containers, trailers, mobile supply trucks, or tank cars.
- (4) The scope, or extent, of the applicability of NFPA 50A (1994) is shown in its definition of a GH₂ system. A GH₂ system is "one in which the hydrogen is delivered, stored, and discharged in the gaseous form to consumer's piping. The system includes stationary or movable containers, pressure regulators, pressure relief devices, manifolds, interconnecting piping, and controls. The system terminates at the point at which hydrogen at service pressure first enters the consumer's distribution piping."

c. NFPA 50B, Liquefied Hydrogen Systems at Consumer Sites.

- (1) NFPA 50B (1994) covers the requirements for the installation of LH₂ systems on consumer premises for which the hydrogen supply to the consumer premises originates outside the consumer premises, and is delivered by mobile equipment.
- (2) This standard does not apply to the following:
 - (a) Portable containers having a total LH₂ content of less than 150 L (39.7 gal).
 - (b) LH₂ manufacturing plants or other establishments operated by a hydrogen supplier or the supplier's agent

for the sole purpose of storing LH₂ and refilling portable containers, trailers, mobile supply trucks, or tank cars.

- (3) The scope, or extent, of the applicability of NFPA 50B (1994) is shown in its definition of a LH₂ system. A LH₂ system is “a system into which liquefied hydrogen is delivered and stored and from which it is discharged in the liquid or gaseous form to consumer piping. The system includes stationary or portable containers, including unconnected reserves, pressure regulators, pressure relief devices, manifolds, interconnecting piping, and controls as required. The system originates at the storage container fill connection and terminates at the point hydrogen at service pressure first enters the supply line.”

d. 29 CFR 1910.103, Hydrogen.

- (1) Over time several standards were developed, especially to give QD recommendations; eventually some of these were incorporated into the Code of Federal Regulations, and thus compliance made mandatory. NFPA 50A (1994) and NFPA 50B (1994) for GH₂ and LH₂ storage, were incorporated almost completely into 29 CFR 1910.103 (1996) for example.
- (2) Part 1910, Occupational Safety and Health Standards, of 29 CFR (1996) provides regulations related to safety in the work place. Subpart H, Hazardous Materials, of 29 CFR 1910 (1996) addresses the safe handling of hazardous materials in the workplace. An outline of 29 CFR 1910 Subpart H, “Hazardous Materials” (1996), is given below.

1910.101	Compressed gases (general requirements)
1910.102	Acetylene
1910.103	Hydrogen
1910.104	Oxygen
1910.105	Nitrous oxide
1910.106	Flammable and combustible liquids
1910.107	Spray finishing using flammable and combustible materials
1910.108	Dip tanks containing flammable or combustible liquids
1910.109	Explosives and blasting agents
1910.110	Storage and handling of liquified petroleum gases
1910.111	Storage and handling of anhydrous ammonia
1910.112	Reserved
1910.113	Reserved
1910.114	Effective dates
1910.115	Sources of standards

1910.116	Standards organizations
1910.119	Process safety management of highly hazardous chemicals
1910.120	Hazardous waste operations and emergency response

D.5 DIRECTIVES FOR THE PROPELLANT USE OF LIQUEFIED HYDROGEN.

a. General.

- (1) Two directives that apply to LH₂ installations where liquid propellants are present and cover all types of liquid propellant storage areas, including missiles, rockets, and multicompart ment tanks in which liquid fuels and liquid oxidizers are stored are NASA NSS 1740.12 (1993) and DoD 6055.9 (1992).
- (2) With experimental facilities, especially if LOX or other powerful oxidizers are present and used in the same experimental programs, mechanisms other than those for the nonpropellant use of hydrogen exist for accidents. Siting concerns include handling large quantities and high use rates. Hydrogen is included in the Group III Hazard Grouping in which the hazards primarily are from the pressure rupture of the storage container, deflagration, and vapor phase explosions. Pressure rupture of the container or vapor phase explosion can cause a fragment hazard from the container and its protective structure, or other adjacent material.
- (3) The DoD and NASA guidelines for Bulk Storage (this is the most remote storage with respect to launch and test operations, and never directly connected to any of them) is that fire and fragment hazards govern. The explosive equivalents shall be used to determine QDs if positive measures are not taken to prevent mixing of fuel and oxidizer or to prevent detonation propagation (NSS 1740.12 1993 and DoD 6055.9 1992).

b. NASA NSS 1740.12, Safety Standard for Explosives, Propellants, and Pyrotechnics.

- (1) NASA Directive NSS 1740.12 (1993) is based on DoD 6055.9 (1992). The QD guidelines in the documents were developed to protect from fragments, fire, overpressure, and impulse following an explosion, a potential hazard in which the

probability is increased by the presence of oxidizers or mixed propellants being used in the same operation. An example of the calculations for siting an LH₂ storage dewar used to provide LH₂ to an experimental test cell is given in Appendix B, Example B6.

- (2) NSS 1740.12 (1993) is the central Agency document containing policy and safety requirements that define the NASA Explosives, Propellant, and Pyrotechnics Safety Program.
- (3) NSS 1740.12 (1993) primarily addresses explosives safety; however, some health aspects are included.
- (4) NSS 1740.12 (1993) contains the minimum explosives, propellant, and pyrotechnics safety requirements. Additional explosive safety publications have been developed for which instructions are too detailed for inclusion in NSS 1740.12 (1993) or require special distribution.
- (5) NSS 1740.12 (1993) is applicable to all NASA facilities engaged in the development, manufacturing, handling, storage, transportation (on/offsite), processing, or testing of explosives, or assemblies containing explosives. It provides procedures for operations involving explosives, propellants, and pyrotechnics, and the safe management of such operations.
- (6) The propellant section of NSS 1740.12 (1993) applies to storage of liquid propellants in all types of containers, including rocket and tank, in quantities greater than a single shipping container such as one 189-L (55-gal) drum or one 227-kg (500-lb) cylinder net weight.
- (7) Liquid propellant presents various types and degrees of hazards. Based on these hazards, the following propellant groupings are established:
 - (a) Group I (Fire Hazard)
 - (b) Group II (Serious Fire Hazard)
 - (c) Group III (Pressure Rupture, Vapor Phase Explosion, Fragments)
 - (d) Group IV (Mass Detonating, Severe Fragments)

LH₂ is included in Group III. Hazards in this group primarily are from pressure rupture of the storage container, resulting from

fire, deflagration, or vapor-phase explosion. Hazardous fragmentation of the container, its protective structure, or other nearby material may be produced by pressure rupture of the storage container or a vapor-phase explosion.

- (8) The major hazard of the individual propellant can vary depending on the location of the propellant storage and operations involved. The storage and operations conditions, in order of decreasing hazards, follow:
- (a) Range launch pads
 - (b) Static test stands
 - (c) Ready storage
 - (d) Cold-flow test operations
 - (e) Bulk storage
 - (f) Run tankage
 - (g) Pipelines
 - (h) Fire and fragment hazards in cold-flow test operations govern if the design is such that the system is closed (except for approved venting), is completely airtight, fuel and oxidizer are never employed concurrently and each has a completely separate isolated system, and propellants are of the required purity. Otherwise, explosive equivalents must be used to determine QDs.
 - (i) Bulk storage is the most remote storage with respect to launch and test operations, as it is never directly connected to any of them. It consists of the area, tanks, and other containers used to hold propellants for supplying ready storage and, indirectly, run tankage when no ready storage is available. Individual bulk storage facilities must be separated from each other and unrelated exposures. Explosive equivalents must be used to determine QDs if positive measures are not taken to prevent mixing.
 - (j) A 7.6-m (25-ft) clear zone to inhabited buildings shall be maintained on each side of pipelines used for Group II or III propellants between unloading points and storage areas or between storage areas and points of use.

- (9) Separation distances shall be measured from the closest hazard source (containers, buildings, segment, or positive cutoff point in piping, whichever is controlling).

c. DoD 6055.9, DoD Ammunition and Explosives Standards

- (1) The purpose of this DoD 6055.9 (1992) is to establish uniform safety standards applicable to ammunition and explosives, associated personnel and property, and unrelated personnel and property exposed to the potential damaging effects of an accident involving ammunition and explosives during their development, manufacturing, testing, transportation, handling, storage, maintenance, demilitarization, and disposal. The standards are considered minimum. They apply to DoD ammunition and explosives facilities and are designed to provide protection against serious injury, loss of life, and damage to property. The standards address the following subject areas:

- (a) Effects of explosives and permissible exposure
- (b) Hazard classification and compatibility groups
- (c) Personnel protection
- (d) Facility construction and siting
- (e) Electrical
- (f) Lightning protection
- (g) Hazard identification for fire fighting
- (h) QD
- (i) Theater of operations QD
- (j) Chemical agents
- (k) Real property contaminated with ammunition and explosives
- (l) Mishap reporting and investigation requirements

- (2) The damage or injury potential of explosions normally is determined by the distance prevailing between the Potential

Explosion Site (PES) and the Exposed Site (ES); the ability of the PES to suppress blast overpressure, primary and secondary fragments, and debris; and the ability of the ES to resist explosion effects. The section on liquid propellants sets minimum standards for separating a PES from an ES taking into account explosion effects suppression and resistance anticipated. QD relationships are established for related and unrelated PESs and explosives and nonexplosive ESs.

- (3) The section on liquid propellants applies to their storage in all types of containers, including rocket and missile tankage, in quantities greater than single minimum size shipping container such as one 189 L (55 gal) drum or one 227 kg (500 lb) cylinder net weight. Smaller quantities are to be stored and handled as prescribed by the controlling DoD Component.
- (4) These standards are based on the estimated credible damage resulting from an incident, without considering probabilities or frequency of occurrence.
- (5) Quantity of propellant in the associated piping must be included to the points that positive means are provided for interrupting the flow through the pipe or interrupting a reaction in the pipe in the event of an incident.
- (6) Separation distances shall be measured from the closest hazard source (containers, buildings, segment, or positive cutoff point in piping, whichever is controlling).
- (7) A 7.6-m (25-ft) clear zone to inhabited buildings shall be maintained on each side of pipelines used for Group II or III propellants.

D.6 REGULATIONS FOR TRANSPORTATION EQUIPMENT AND THE TRANSPORT OF HYDROGEN

a. Regulations.

Regulations related to transportation equipment and to the transport of hydrogen are given in 49 CFR, Subtitle B, Chapter I, Subchapters A, B, and C (1995) in the various parts of these subchapters as shown in the following outline.

49 CFR - Transportation
Subtitle B - Other Regulations Relating to Transportation

CHAPTER I - RESEARCH AND SPECIAL PROGRAMS
ADMINISTRATION, DEPARTMENT OF
TRANSPORTATION

SUBCHAPTER A - HAZARDOUS

TRANSPORTATION, OIL
TRANSPORTATION AND
PIPELINE SAFETY

Part 100 - [Reserved]

Part 106 - Rule making procedures

Part 107 - Hazardous materials
program procedures

Part 110 - Hazardous materials
public sector training and
planning grants

SUBCHAPTER B - OIL TRANSPORTATION

Part 130 - Oil spill prevention and
response plans

SUBCHAPTER C - HAZARDOUS MATERIALS
REGULATIONS

Part 171 - General information,
regulations, and
definitions

Part 172 - Hazardous materials
tables and hazardous
materials communications
regulations

Part 173 - Shippers-general
requirements for
shipments and packagings

Part 174 - Carriage by rail

Part 175 - Carriage by aircraft

Part 176 - Carriage by vessel

Part 177 - Carriage by public
highway

Part 178 - Specifications for
packagings

Part 179 - Specifications for tank
cars

Part 180 - Continuing qualifications
and maintenance of
packagings

b. Scope of Subchapter C.

Subchapter C prescribes the requirements of the DOT governing the following:

- (1) The transportation of hazardous materials by, and their offering to the following:
 - (a) Carriers by rail car, aircraft, and vessel (water craft such as ship, ferry, and barge)
 - (b) Interstate and foreign carriers by motor vehicle
 - (c) Intrastate carriers by motor vehicle so far as Subchapter C relates to the following
 - 1 Hazardous waste
 - 2 Hazardous substances
 - 3 Flammable cryogenic liquids in portable tanks and cargo tanks
 - 4 Marine pollutants
- (2) The manufacture, fabrication, marking, maintenance, reconditioning, repairing, or testing of a packaging or container represented, marked, certified, or sold for use in such transportation as described above
- (3) Any person who, under contract with any department, agency, or instrumentality of the executive, legislative, or judicial branch of the Federal Government, transports, or causes to be transported or shipped, a hazardous material or manufacturers, fabricates, marks, maintains, reconditions, repairs, or tests a package or container represented, marked, certified, or sold by such person as qualified for use in the transportation of hazardous materials

c. Hazard Classification for GH₂ and LH₂.

Compressed and liquefied hydrogen are designated as a Hazard class, or Division, of 2.1 (Flammable Gas) in 49 CFR 172.101 (1995) and 49 CFR 173.2 (1995).

Table D1 (continued)
 Selection of Federal Regulations for Hydrogen Transportation

49 CFR Part No.	Description
General Requirements for Shipments and Packaging	
173.11	Shipper's registration statement; flammable cryogenic liquids
173.31	Qualification, maintenance, and use of tank cars
173.33	Hazardous materials in cargo tank motor vehicles
173.34	Qualification, maintenance and use of cylinders (hydrogen-specific requirements listed)
173.115	Class 2, Divisions 2.1, 2.2, & 2.3-Definitions (hydrogen is designated as 2.1)
173.301	General requirements for shipment of compressed gases in cylinders (hydrogen-specific requirements listed)
173.302	Charging of cylinders with nonliquefied compressed gases (hydrogen-specific requirements listed)
173.314	Requirements for compressed gases in tank cars; (hydrogen-specific requirements listed)
173.315	Compressed gases in cargo tanks and portable tanks
173.316	Cryogenic liquids in cylinders (hydrogen-specific requirements listed)
173.318	Cryogenic liquids in cargo tanks (hydrogen-specific requirements listed)
173.319	Cryogenic liquids in tank cars (hydrogen-specific requirements listed)
173.320	Cryogenic liquids; exceptions
177.822	Acceptable articles
177.823	Marking and placarding motor vehicles
177.824	Retesting and inspection of cargo tanks
177.826	Carrier's registration statement; flammable cryogenic liquids (includes Division 2.1 materials)
Rail Transportation	
172.101	Purpose and use of hazardous materials table (GH ₂ and LH ₂ are forbidden on passenger rail service)
173.11	Shipper's registration statement; flammable cryogenic liquids
173.31	Qualification, maintenance, and use of tank cars
173.302	Charging of cylinders with nonliquefied compressed gases (hydrogen-specific requirements listed)
173.314	Requirements for compressed gases in tank cars; (hydrogen-specific requirements listed)
173.319	Cryogenic liquids in tank cars (hydrogen-specific requirements listed)

Table D1 (continued)
 Selection of Federal Regulations for Hydrogen Transportation

49 CFR Part No.	Description
Rail Transportation (continued)	
174	Carriage by Rail
174.200	Special handling requirements (Division 2.1 materials)
174.201	Class 2 (gases) material cylinders
174.204	Tank car delivery of gases, including cryogenic liquids
179	Specifications for Tank Cars
179.10	Tank mounting
179.13	Tank car capacity and gross weight limitation
179.400	General specifications applicable to cryogenic liquid tank cars (includes DOT-113A60W tank cars for transport of LH ₂)
179.401	Individual specification requirements applicable to inner tanks for cryogenic liquid tank car tanks (hydrogen-specific requirements)
179.500	Specification DOT-107A * * * * seamless steel tank car tanks
Aircraft Transportation	
172.101	GH ₂ forbidden on passenger aircraft; 150 kg max. permitted on cargo aircraft LH ₂ forbidden on passenger or cargo aircraft
173.27	General requirements for transportation by aircraft
173.302	Charging of cylinders with nonliquefied compressed gases (hydrogen-specific requirements listed)
173.320	Cryogenic liquids; exceptions
175	Carriage by Aircraft
Vessel (Watercraft) Transportation	
172.101	Purpose and use of hazardous materials table (GH ₂ forbidden on passenger vessels; must be stowed “on deck” or “under deck on a cargo vessel LH ₂ forbidden on passenger vessels; must be stowed “on deck” on a cargo vessel)
172.101 & 176.84	GH ₂ and LH ₂ must be stowed “clear of living quarters” and GH ₂ must be stowed “separate from” chlorine
173.11	Shipper’s registration statement; flammable cryogenic liquids
173.318	Cryogenic liquids in cargo tanks (hydrogen specific requirements listed)
176	Carriage by Vessel

Table D1 (continued)
 Selection of Federal Regulations for Hydrogen Transportation

49 CFR Part No.	Description
Vessel (Watercraft) Transportation (continued)	
176.76	Transport vehicles, freight containers, and portable tanks containing hazardous materials
176.83	Segregation (Division 2.1 materials included)
176.84	Other requirements for storage and segregation for cargo vessels and passenger vessels (hydrogen specific requirements listed)
176.200	General storage requirements (for compressed gases)
176.205	Under deck stowage requirements (for compressed gases, including Division 2.1 materials)
176.210	On deck stowage requirements (for compressed gases)
176.220	Smoking or open flame and posting of warning signs
176.230	Stowage of Division 2.1 (flammable gases) materials
Public Highway Transport	
173.11	Shipper's registration statement; flammable cryogenic liquids
173.33	Hazardous materials in cargo tank motor vehicles
173.34	Qualification, maintenance and use of cylinders (hydrogen-specific requirements listed)
173.302	Charging of cylinders with nonliquefied compressed gases (hydrogen-specific requirements listed)
173.314	Requirements for compressed gases in tank cars (hydrogen specific requirements listed)
173.315	Compressed gases in cargo tanks and portable tanks
173.316	Cryogenic liquids in cylinders (hydrogen-specific requirements listed)
173.318	Cryogenic liquids in cargo tanks (hydrogen-specific requirements listed)
177	Carriage by Public Highway
177.816	Driver training
177.818	Special instructions; Division 2.1 (flammable gas) materials that are cryogenic liquids
177.822	Acceptable articles
177.823	Marking and placarding motor vehicles
177.824	Retesting and inspection of cargo tanks
177.826	Carrier's registration statement; flammable cryogenic liquids (includes Division 2.1 materials)

177.834 General requirements (Loading and Unloading) (includes Class 2
(gases) and Division 2.1 (flammable gas` materials)

Table D1 (continued)
 Selection of Federal Regulations for Hydrogen Transportation

49 CFR Part No.	Description
Public Highway Transport (continued)	
177.840	Class 2 (gases) materials (includes Division 2.1 materials; hydrogen-specific requirements listed)
177.848	Segregation of hazardous materials
177.853	Transportation and delivery of shipments (includes Class 2 (gases) and Division 2.1 materials)
177.859	Accidents; Class 2 (gases) materials (includes Division 2.1 materials)
178.57	Specification 4L; welded cylinders insulated (LH ₂ may be shipped in a DOT-4L cylinder)
Packagings	
178.3	Marking of packagings
178.37	Specification 3AA; seamless steel cylinders made of definitely prescribed steels or 3AAAX; seamless steel cylinders made of definitely prescribed steels of capacity of over 1,000 pounds water volume
178.57	Specification 4L; welded cylinders insulated (LH ₂ may be shipped in a DOT-4L cylinder)
178.320	General requirements applicable to all DOT specification cargo tank motor vehicles
178.337	Specification MC 331; cargo tank motor vehicle primarily for transportation of compressed gases as defined in Subpart G of Part 173 of this subchapter
178.338	Specification MC-338; insulated cargo tank
178	Appendix A - Specifications for Steel
178	Appendix B - Alternative Leakproofness Test Methods
180	Continuing Qualification and Maintenance of Packagings

D.7 REFERENCES

- ANSI/ASME B31.3. *Process Piping*. American Society of Mechanical Engineers, New York, NY (1996).
- ASME. *ASME Boiler and Pressure Vessel Code, Section V, Nondestructive Examination*. American Society of Mechanical Engineers, New York, NY (1995).
- ASME. *ASME Boiler and Pressure Vessel Code, Section VIII, Rules for Construction of Pressure Vessels, Division 1*. American Society of Mechanical Engineers, New York, NY (1995).
- ASME. *ASME Boiler and Pressure Vessel Code, Section IX, Welding and Brazing Qualifications Procedures*. American Society of Mechanical Engineers, New York, NY (1995).
- Bender, F. X., Private Communication.
- CFR Title 29. *Occupational Health and Safety Standards*. Code of Federal Regulations. Parts 1900 to 1910, U.S. Government Printing Office, Washington, 1993.
- CFR Title 49. *Transportation*. Code of Federal Regulations. Parts 106-180, Spring 1994 Edition, GSI Computer Services, Branson, MO
- CGA G-5.4. *Standard for Hydrogen Piping Systems at Consumer Locations*. Compressed Gas Association. Arlington, VA (1992).
- Connolly, W. W., "A Practical Safety Standard for Commercial Handling of Liquefied Hydrogen," in Advances in Cryogenic Engineering, Vol. 12, Plenum Press, New York, 1967.
- DoD 6055.9. *Ammunition and Explosives Safety Standards*. Department of Defense, 1992.
- NASA TM 104438, Lewis Safety Manual, Chapter 6, Hydrogen Propellant, 1992.
- NFPA 50A. *Standard for Gaseous Hydrogen Systems at Consumer Sites*. National Fire Protection Association, Inc., Quincy, MA (1994).
- NFPA 50B. *Standard for Liquefied Hydrogen Systems at Consumer Sites*. National Fire Protection Association, Inc., Quincy, MA (1994).
- NSS 1740.12. *NASA Safety Standard for Explosives, Propellants, and Pyrotechnics*. National Aeronautics and Space Administration, Washington, DC (1993).

APPENDIX E

RELIEF DEVICES

E.1 GENERAL

- a. The nomenclature used in discussing relief devices is defined as follows:
- (1) Operating pressure. The pressure at which a piping system is to be used on a steady-state basis. It may range from a vacuum to the design pressure. Special consideration should be given to the relief device choice to prevent simmer (preopening leakage) if a pressure higher than 90 percent of design is used.
 - (2) Set pressure. The pressure at which a protective device is set to discharge.
 - (3) Maximum Allowable Working Pressure (MAWP). The maximum pressure permissible at the top of a vessel in its normal operating position at the coincident operating temperature. It is the least of the values found based on calculations for every element of the vessel using nominal thickness exclusive of any allowances for corrosion or loadings other than pressure, and adjusted for any difference for static head that may exist between the part considered and the top of the vessel.
 - (4) Design Pressure. The pressure used in the design of a vessel for the purpose of determining the minimum required thickness of the components of the vessel. When applicable, static head shall be added to the design pressure.
 - (5) Protective device. A generic term for any device designed to limit the pressure in a piping system.
 - (6) Safety device. An automatic protective device actuated by the static pressure upstream of the device and characterized by full opening pop action.
 - (7) Relief device. An automatic, reseatable protective device actuated by the static pressure upstream of the device and for which the opening is proportional to the increase in pressure over the opening pressure.

- (8) Safety relief device. A protective device combining the functions of a safety device and relief device, usually being proportional during the first part of its stroke and having pop action during the last part.
 - (9) System relief device. A protective device designed to the system pressure. This device should be set at or below the design pressure and should prevent the pressure from rising more than 10 percent above the design pressure.
 - (10) Isolation protective device. A protective device required on each isolatable piping section not directly connected to any external pressure source and for which the only pressure source when isolated is the nominal heat leak into the line. It should be set to open on a pressure no greater than 125 percent of the design pressure or 85 percent of the test pressure, whichever is lower. It should be sized to prevent the pressure from rising no more than 10 percent above these limits.
 - (11) Supplemental protective device. A protective device installed to protect against excessive pressure from abnormal sources or conditions. This device should be capable of preventing the pressure from rising above the test pressure. Its set pressure should not exceed 85 percent of the test pressure. It may be a safety or relief device.
- b. Pressure-relief devices should be applied to all systems having a pressure source that can exceed the maximum allowable pressure of the system or for which the malfunction or failure of any component can cause the maximum allowable pressure to be exceeded. Relief devices are required downstream of all regulating valves and orifices unless the downstream system is designed to accept full source pressure. The protection provided by the ground pressurization system should be considered satisfactory when spacecraft operational or weight limitations preclude the use of relief valves and the systems operate in an environment not hazardous to personnel (unmanned spacecraft) only if that protection cannot be isolated from the spacecraft.
 - c. All pressure-relief devices should be sized and tested in accordance with the capacities of the pressure source and provide initial relief at the maximum allowable working pressure, or lower, in accordance with ASME, BPVC Section VIII.
 - d. Shutoff valves for maintenance purposes on the inlet side of a pressure-relief valve may be used if a means for monitoring and

bleeding trapped pressure is provided. It is mandatory that the valve be locked open when the system is repressurized.

- e. Hydrostatic testing systems for vessels not designed to sustain negative internal pressure should be equipped with fail-safe devices for relieving hazardous negative pressure during fluid removal. Thin-walled vessels that could be collapsed by a combination of events causing negative pressure should have negative pressure relief or prevention devices for safety during empty storage and transportation.
- f. LH₂ vessels and each section of LH₂ piping capable of being isolated must be considered to be a pressure vessel with a source of external energy. This energy, for which the source is the heat leak into the line, can cause the pressure to increase many orders of magnitude as the fluid in the line heats to atmospheric temperature. Each such section must be equipped with a protective device for overpressure control. Vacuum spaces shall have overpressure protection.
- g. Insulated lines should be considered to be intact for sizing primary devices and catastrophically failed for sizing supplemental devices in designing relief systems. Insulation failures in LH₂ systems can cause air condensation and an increased heat flux into the system.
- h. The following guidelines should be followed when evaluating devices against excessive pressures:
 - (1) The necessary amount to be blown off should be distributed if several safety devices are used so the remaining devices can blow off at least 75 percent of the total amount required if the largest safety device should fail.
 - (2) Two independent sources of energy should be available: energy pipelines and driving mechanisms. If the pressure of the medium to be safeguarded serves for the drive, this is sufficient as one source of energy.
 - (3) The interval between start of excess pressure and full opening of the safety device should not be more than 5 s.
- i. Safety valves should be unloadable and liftable. The force exerted by springs or weights should be reducible by hand operation from outside.
- j. The pipelines and safety valves should be secured, taking into account local working conditions, so the static dynamic stresses (reaction forces) occurring with the quickest opening and closing can be taken up safely. All cross sections and pipelines should be designed to

ensure the necessary discharge and undisturbed functioning of the safety valve. The material of all parts stressed by hydrogen during operations and testing should be suitable for the temperature and pressure conditions arising.

- k. Pressure-relief systems should protect against a pressure regulator sticking or failing in the fully open position.
- l. The maximum internal pressure and temperature allowed shall include considerations for occasional loads and transients of pressure and temperature. Variations in pressure and temperature may occur; therefore the piping system, except as limited by component standards or by manufacturers of components, shall be considered safe for occasional, short operating periods at higher than design pressure or temperature. Occasional variations above design conditions shall remain within the limits for pressure design as specified in ASME B31.3 (1996) paragraph 302.2.4 or ASME B31.1 (1995) paragraph 102.2.4, as appropriate.

E.2 RUPTURE DISKS

- a. Rupture disks are safety devices against excess pressure. They are specially dimensioned bursting elements, destroyed or permanently deformed on response.
- b. In contrast to safety valves, blowoff orifices remain open after the rupture disk bursts. A similarly tested bursting element needs to be mounted or an exchange device inserted for further operation of the vessel. The rupture disk needs to be directly connected with the pressure space to be protected and may not be shut off. A changeover valve or similarly controlled fitting (interlocking device) is permissible in front of the rupture disk if two rupture disks are present and one serves as a reserve, provided one of the two rupture disks is always positively connected to the pressure space. The reliability of the interlocking device should be confirmed.
- c. A rupture disk can be connected in series with a safety valve if it is operationally appropriate and it is not necessary to reckon with a rapid pressure rise (response inertia of safety valves). It should be ensured by suitable measure that fragments from bursting elements do not make the safety valve ineffective and cannot restrict the outflow cross section. It is also necessary to avoid the possibility of counter pressure (leaky disk) building up in the space between the rupture disk and safety valve because this affects the response pressure level of the disk.

- d. The strength properties of the material used for the bursting elements should exhibit the least possible dependence on the type of stress (static or distention), temperature, and duration of the stress (curve of creep dependent on time).

E.3 CAPACITY RATING OF RELIEF DEVICES

- a. Some suggested heat leaks into LH₂ and LN₂ piping, and estimates of the the gas evolved are given in Table E1.
- b. The method of determining the capacity rating of a cryogenic relief device is recommended in 29 CFR 1910.103. The capacity rating of a cryogenic relief device may be determined by the following formulas:

$$h_0 = h_1 + \frac{V_1^2}{2gJ} \quad (\text{Eq. E1})$$

$$W_c = A_t V_1 V_1 \quad (\text{Eq. E2})$$

$$K = \frac{W_a}{W_c} \quad (\text{Eq. E3})$$

where:

h_0	=	enthalpy of fluid at valve inlet, when velocity is assumed to be zero (Btu/lb)
h_1	=	enthalpy of fluid at throat (Btu/lb)
V_1	=	velocity of fluid at throat (Btu/lb)
W_c	=	calculated flow rate (lb/s)
A_t	=	area of throat (ft ²)
ζ_1	=	density of fluid at throat (lb/ft ³)
W_a	=	measured flow rate (lb/s)
S	=	entropy (Btu/lb °R)
$2gJ$	=	proportionality constant

$$2gJ = 2 * \frac{32.2 \text{ lb} \cdot \text{ft}}{\text{lb} \cdot \text{s}^2} * \frac{778 \text{ ft} \cdot \text{lb}}{\text{Btu}} = 501032 \frac{\text{lb} \cdot \text{ft}^2}{\text{Btu} \cdot \text{s}^2}$$

Table E1Considerations for Relief Devices in LH₂^a Pipelines

Nominal Pipe Size (in.)	External Area of Pipe (ft ² /ft)	Heat Leak per 100 ft of pipe ^b (Btu/min)				Gas Evolved per 100 ft of pipe (ft ³ /min)			
		Natural		Forced		Natural		Forced	
		LN ₂ ^c	LH ₂	LN ₂	LH ₂	LN ₂	LH ₂	LN ₂	LH ₂
0.5	0.220	220	1280	990	2200	36	1270	160	2180
1	0.344	340	2000	1550	3440	55	1980	252	3400
2	0.622	620	3600	2800	6200	100	3560	450	6140
3	0.916	920	5340	4130	9200	149	5300	671	9100
4	1.178	1180	6840	5300	11800	191	6790	860	11700
6	1.725	1725	10000	7760	17250	279	9900	1255	17100
8	2.27	2270	13150	10200	22580	367	13000	1650	22400
10	2.77	2770	16050	12450	27700	449	15900	2020	27400
12	3.33	3330	19300	15000	33300	539	19100	2430	32900

^a LH₂ is liquid hydrogen

^b Based on the following experimental heat flux values (Btu/min•ft²):

10 liquid nitrogen (natural convection)

45 liquid nitrogen (forced convection at 15 mph wind)

100 Liquid hydrogen (forced convection at 15 mph wind)

^c LN₂ is liquid nitrogen

c. The properties and characteristics of hydrogen exiting from a relief device may vary depending on the particular fluid regions of the liquid, vapor, or gas. The following are recommended solutions for the various fluid regions:

(1) Region I: subcooled liquid

Isentropic expansion reaches the liquid line before establishing equality at sonic velocity in Region I. Solve equation E1 in the following form:

$$V_1^2 \text{sat} = (h_0 - h_s) 2gJ \quad (\text{Eq. E4})$$

and solve equation E2 using the saturation velocity V_{sat} and the liquid saturation density.

(2) Region II: superheated fluid

Isentropic expansion establishes equality before the fluid reaches either saturated fluid line in Region II. The ideal throat velocity is sonic velocity at the solution point. Use the related density to solve equation E2.

(3) Region III: supersaturated gas

The fluid is a supersaturated gas if the isentropic expansion reaches the saturated vapor line on the temperature-entropy diagram before equality is established; insufficient time is available and too few nuclei are present for condensation. Its properties are determined in the following fashion:

(a) Evaluate at the saturation pressure P_{sat} , $4/3 \times P_{\text{sat}}$, and $5/3 \times P_{\text{sat}}$ for all physical properties, and generate equations of the following form for each property:

$$X = C_0 + C_1 P + C_2 P^2 \quad (\text{Eq. E5})$$

(b) Continue the expansion, assuming entropy is constant, until equation E1 is solved by using the extrapolated values of enthalpy and sonic velocity generated by the polynomials.

(c) Evaluate equation E2 by using the extrapolated values of density and sonic velocity.

(4) Region IV: saturated vapor

Use the method of Region III except start at P_{sat} and evaluate the properties at constant entropy upward for $4/3 \times P_{sat}$ and $5/3 \times P_{sat}$ for the common cause in cryogenic systems of a relief device relieving a saturated vapor (Region IV). Again, extrapolate and solve equation E1. A series of solutions of this type can be correlated against saturation pressure in the manner of Napier's formula for steam. The following formulas may be used for initial saturation pressures ranging from 207 kPa (30 psia) to two-thirds of the critical pressure:

Oxygen	$W = 0.0410(AP)$
Nitrogen	$W = 0.0422(AP)$
Hydrogen	$W = 0.0231(AP)$

where:

W = flow rate, lb/s

A = area, in.²

P = pressure, psia

Extending these equations to higher pressures is not recommended because the saturation enthalpy is not constant and the true solution deviates too far from the average value shown.

d. Relieving pressures. The recommended principles are listed as follows:

(1) Single Device.

(a) Set pressure # design pressure (DP)

(b) Maximum relieving pressure # 1.2 DP

(2) Supplementary Device.

(a) Set pressure not specified

(b) Maximum relieving pressure # 1.33 DP and £ test pressure

- (3) Thermal Device.
 - (a) Set pressure # 1.25 DP
 - (b) Maximum relieving pressure # test pressure

E.3 REFERENCES

ANSI/ASME B31.1. *Power Piping*. National Standard Code for Pressure Piping
American Society of Mechanical Engineers, New York, NY (1995).

ANSI/ASME B31.3. *Process Piping*. American Society of Mechanical Engineers,
New York, NY (1996).

ASME. *ASME Boiler and Pressure Vessel Code, Section VIII, Rules for
Construction of Pressure Vessels, Division 1*. American Society of
Mechanical Engineers, New York, NY (1995).

CFR Title 29. *Occupational Health and Safety Standards*. Code of Federal
Regulations. Part 1910, Sects. 38(e), 103(h), 106(h), 119(h), 120(h),
132(i), 133(i), 134(8), 146(j), 156(l), 165(l), 1027(z), (latest revision).

APPENDIX F

ABBREVIATIONS AND ACRONYMS

AHJ	Authority Having Jurisdiction
AISI	American Iron and Steel Institute
ANSI	American National Standards Institute
API	American Petroleum Institute
ASME	American Society of Mechanical Engineers
ASTM	American Society for Testing and Materials
BPVC	Boiler and Pressure Vessel Code (ASME)
CBrF ₃	Bromotrifluoromethane
CCD	Charge Coupled Device
CFR	Code of Federal Regulations
CF	Cubic Feet @ 101.3 kPa (14.7 psia), 294.1 K (70 °F)
CGA	Compressed Gas Association
CH ₃ Br	Bromomethane
CM	Cubic Meters @ 101.3 kPa (14.7 psia), 294.1 K (70 °F)
CO ₂	Carbon Dioxide
DI	Deionized
DoD	Department of Defense
DOT	Department of Transportation
fcc	Face-Centered Cubic
GH ₂	Gaseous Hydrogen
GN ₂	Gaseous Nitrogen
GOX	Gaseous Oxygen
H ₂ O	Water
HCFC	Hydrochlorofluorocarbons
He	Helium
ICS	Incident Command System
IEEE	Institute of Electrical and Electronic Engineering
IMS	Incident Management Statement
IPA	Isopropyl Alcohol
IR	Infrared
JSC	Johnson Space Center
KHB	Kennedy Handbook
KSC	Kennedy Space Center

LeRC	Lewis Research Center
LFL	Lower Flammability Limit
LH ₂	Liquefied Hydrogen
LN ₂	Liquefied Nitrogen
LNG	Liquefied Natural Gas
LOX	Liquid Oxygen
MAWP	Maximum Allowable Working Pressure
MSDS	Material Safety Data Sheet
MSFC	Marshall Space Flight Center
NASA	National Aeronautics and Space Administration
N ₂	Nitrogen
NBP	Normal Boiling Point
NBS	National Bureau of Standards
NBT	Normal Boiling Temperature
NFPA	National Fire Protection Agency
NHB	NASA Handbook
NHS	NASA Hazard Standard
NIST	National Institute of Standards and Technology
NMI	NASA Management Instruction
NSS	NASA Safety Standard
NTP	Normal Temperature and Pressure, 101.3 kPa (14.7 psia); 293 K (68 °F)
QD	Quantity Distance
SI	International System of Units
SLH ₂	Slush hydrogen
SOW	Statement of Work
SSC	Stennis Space Center
STD	Standard
STP	Standard Temperature and Pressure, 101.3 kPa (14.7 psia); 273 K (32 °F)
TLV	Threshold Limit Value
TM	Technical Manual
TNT	Trinitrotoluene
UFL	Upper Flammability Limit
UV	Ultraviolet
VIS	Visible
WSTF	White Sands Test Facility

APPENDIX G

GLOSSARY

ACCEPTANCE TEST. A standard test that leads to certification of a component or system.

ATTENDANT. An individual stationed outside one or more permit-required confined spaces who monitors the authorized entrants and who performs all attendant's duties assigned in the employer's permit-required confined space program. Authorized entrant means an employee who is authorized by the employer to enter a permit-required confined space.

AUTOIGNITION. The phenomenon in which a mixture of gases, vapors, mists, dusts, or sprays ignites spontaneously with no external ignition source. It is frequently called *autogenous ignition* or *spontaneous ignition*.

AUTOIGNITION TEMPERATURE. The lowest temperature at which a material will spontaneously ignite. No additional ignition energy (ignition source) is required.

BLAST WAVE. Pressure pulse following a shock wave. It is due to velocity, imparted by the shock wave, to the medium particles.

BLEVE. (Boiling Liquid Expanding Vapor Explosion) Liquefied gases usually (or almost always) are stored in containers at a pressure above that of the local atmosphere and, therefore, they are also at a temperature above that of their NBP. This pressure may be less than 6.9 kPa (1 psi) for some cryogenic gas containers. The sensible heat which is, in effect, "stored" in the liquid, causes very rapid vaporization of a portion of the liquid that rapidly increases with an increase in the temperature difference between that of the liquid at the instant of container failure and the NBP of the liquid if the pressure is reduced to atmospheric, such as through container failure. This can result in vaporization of a significant quantity of the liquid in the container. Liquid vaporization is accompanied by a large liquid-to-vapor expansion. It is this expansion process that provides the energy for propagation of cracks in the container structure, propulsion of pieces of the container, rapid mixing of the vapor and air, resulting in atomization of the remaining cold liquid, and in the case of combustible liquid, in a characteristic fireball upon ignition by the fire that caused the BLEVE. Also, in the case of a combustible liquid, many of the atomized droplets burn as they fly through the air. However, it is not uncommon for the cold liquid to be propelled from the fire zone too fast for ignition to occur and fall to earth still in liquid form.

BUDDY SYSTEM. A system of organizing employees into work groups in such a manner that each employee of the work group is designated to be observed by at least one other employee in the work group. The purpose of the buddy system is to provide rapid assistance to employees in the event of an emergency.

CERTIFICATION. The process that results in the documented status that qualifies a vessel or system to operate in the service for which it is intended or qualifies operating personnel for specific duties. Also refers to the document itself.

COLD TRAP. A surface refrigerated by LN₂ to eliminate water vapor, carbon dioxide, etc. from the gas before it reaches a vacuum pump, and to eliminate diffusion of oil particles back into the vacuum space.

CRYOGENIC. Conditions at low temperatures, usually at or below 123 K (-239 °F).

DEFLAGRATION. A flame moving through a flammable mixture in the form of a subsonic wave (with respect to the unburned mixture).

DETONATION. Exothermic chemical reaction coupled to a shock wave that propagates through a detonable mixture. The velocity of the shock wave is supersonic with respect to the unburned gases. After initiation, the thermal energy of the reaction sustains the shock wave, and the shock wave compresses the unreacted material to sustain the reaction.

DETONATION LIMITS. The upper and lower detonation limits are the maximum and minimum concentrations of a gas, vapor, mists, sprays or dust in air or oxygen for stable detonations to occur. The limits are controlled by the size and geometry of the environment as well as the concentration of the fuel. Detonation Limit is sometimes used as a synonym for Explosive Limit.

DIAPHRAGM. A membrane that can be used as a seal to prevent fluid leakage or an actuator to transform an applied pressure to linear force.

EXCLUSION AREA. An area in which personnel access, equipment, and activities are controlled. Access within an exclusion area is limited to essential personnel whose presence is necessary. Such personnel must meet specific training requirements. Equipment located within an exclusion area must meet specific requirements, such as the elimination or control of ignition sources. Activities and operations within an exclusion area must be carefully planned with the requirements of safety to personnel and reduction of risk to adjacent facilities.

EXPLOSION. The rapid equilibration of pressure between the system and the surroundings, such that a shock wave is produced. Explosions may occur through mechanical failure of vessels containing high pressure fluids or through rapid chemical reactions producing large volumes of hot gases.

EXPLOSIVE YIELD. Energy released in an explosion. It is often expressed as a percent or fraction of the energy that would be released by the same mass of a standard high explosive such as TNT.

FAILURE MODE AND EFFECTS ANALYSIS (FMEA). A systematic, methodical analysis performed to identify and document all identifiable failure modes at a prescribed level and to specify the resultant effect of the modes of failure.

FLAME VELOCITY or FLAME SPEED. Refers to the velocity of propagation of the reaction zone through the flammable mixture, as measured by a stationary observer. Usually measured at the front of the flame.

FLAMMABILITY LIMITS. The lower (LFL) and upper (UFL) vapor concentrations (usually reported as percent by volume) of fuel in a flammable mixture that will ignite and propagate a flame. These limits are functions of temperature, pressure, diluents, and ignition energy.

FLAMMABLE. A flammable material is easily ignited in air, oxygen, or other supporting atmosphere.

FLAMMABLE LIQUID. Liquid with a flash point temperature below 300 K (80 °F) as determined by ASTM standard methods (D56 flash point by TAG closed tester or D92 flash point by Cleveland open cup).

FLASH POINT. The lowest temperature at which a flammable liquid gives off sufficient vapor to form an ignitable mixture with air near its surface or within a vessel. Combustion does not continue.

GAS. A gas is defined in this handbook as a substance that cannot be liquefied by applied pressure at a temperature of 273 K (32 °F).

GASEOUS HYDROGEN (GH₂) SYSTEM. An assembly of components to which hydrogen is delivered, stored, and used in the gaseous form. The system may include storage vessels, piping, valves, relief devices, pumps, vacuum system, expansion joints, and gages. The nature of the working fluid (GH₂) and operating parameters, create hazards to people and the surrounding environment. A GH₂ system as defined in 29 CFR 1910.103 and NFPA 50A is limited to the bulk storage vessel (and ancillary components) from the point of the fill connection to the point where GH₂ enters the distribution piping.

HAZARD. Existing or potential condition that can result in or contribute to a mishap.

HYDROSTATIC TEST. A test performed on a pressure vessel or system in which the vessel or system is filled with a liquid (usually water) and pressurized to a designated level in a manner prescribed in the applicable code.

INTRALINE SEPARATION. The minimum distance to be maintained between operating buildings and sites within an operating line, of which at least one contains, or is designed to contain, propellants or explosives. This distance may be reduced if equivalent protection to personnel and property is provided by building design and construction or a barricade. This distance shall be determined based on the maximum explosives weight.

INTRINSICALLY SAFE INSTALLATION. An installation in which any spark or thermal effect, produced normally or in specified fault conditions, is incapable, under test conditions prescribed in NFPA 493, of causing ignition of a mixture of flammable material in air in its most easily ignited concentration.

LIQUID HYDROGEN (LH₂) SYSTEM. An assembly of components to which hydrogen is delivered, stored, and used in the liquid and/or gaseous form. The system may include storage vessels, piping, valves, relief devices, pumps, vacuum system, expansion joints, and gages. The nature of the working fluid (LH₂ and GH₂) and operating parameters, create hazards to people and the surrounding environment. An LH₂ system as defined in NFPA 50B is limited to the bulk storage vessel (and ancillary components) from the point of the fill connection to the point where LH₂ and/or GH₂ enters the distribution piping.

MAXIMUM ALLOWABLE WORKING PRESSURE (MAWP). The maximum pressure permissible at the top of a vessel in its normal operating position at the coincident operating temperature. It is the least of the values found based on calculations for every element of the vessel.

OVERPRESSURE. The pressure in a blast wave above atmospheric pressure.

PERMIT-REQUIRED CONFINED SPACE. A confined space is not normally occupied by personnel, it has limited or restricted openings for entry and exit, may lack adequate ventilation, may contain or produce dangerous air contamination, and may not be safe for entry.

PNEUMATIC OR PNEUMOSTATIC TEST. A test performed on a pressure vessel or system in which air or gas is introduced and pressurized to a designated level in a manner prescribed in the applicable code. Pneumatic tests are potentially hazardous and all personnel shall be excluded from the hazard zone. Pneumatic tests shall be made following an approved written test procedure.

PORTABLE TANK/CONTAINER. Any tank or container as defined by the U.S. Department of Transportation designed primarily to be temporarily attached to a motor vehicle, other vehicle, railroad car other than tank car, or marine vessel, and equipped with skids, mountings or accessories to facilitate handling of the container by mechanical means, in which any compressed gas is to be transported.

PRESSURE VESSEL. Any vessel used for the storage or handling of gas or liquid under positive pressure. Components of systems are included, such as, heat exchanger shells and drying towers and other shell structures for which the rules of the ASME BPVC, Section VIII would apply.

PROOF TEST. A pressure test performed to establish or verify the maximum allowable working pressure of a vessel, system, or component thereof. May also be used (1) when the strength cannot be computed with a satisfactory assurance of accuracy, (2) when the thickness cannot be determined by means of the design rule of the applicable code or standard, or (3) when the critical flaw size to cause failure at the certified pressure cannot be identified by other nondestructive test methods.

QUENCHING DISTANCE. The gap dimension required to prevent the propagation of an open flame through a flammable fuel-air mixture.

QUENCHING GAP. The quenching gap is defined as the spark gap between two flat parallel-plate electrodes at which ignition of combustible fuel-air mixtures is suppressed; smaller gaps totally suppress spark ignition. The quenching gap is the passage gap dimension requirement to prevent propagation of an open flame through a flammable fuel-air mixture that fills the passage.

RECERTIFICATION. The procedure by which a previously certified vessel or system, by appropriate tests, inspections, examinations, and documentation, is qualified to continue or be returned to operations at the design pressure.

RUPTURE DISK. A nonreclosing pressure-relief device designed to remain open after operation. A manual resetting means may be provided.

SAFETY FACTOR. The ratio, allowed for in design, between the point of failure of a member, material, structure, equipment or system, and the actual working stress or safe permissible load placed on it during ordinary use.

SET PRESSURE. The pressure marked on a safety relief valve at which the pressure relief valve is set to start to discharge.

SHOCK. A violent collision or impact and the subsequent transmission of energy through the system. The energy moves as a wave at velocities greater than the speed of sound relative to the undisturbed material.

STORAGE CONTAINER. Any container designed to be permanently mounted on a stationary foundation and is used to store any compressed gas.

SURFACE FINISH (RMS). The degree of surface roughness as measured by the average deviation from the mean (root-mean-square value) of the maximum peak-to-valley height. The roughness values are commonly given in units of micro-inches (millionths of an inch).

TANK. Any vessel used for the storage or handling of liquids for which the internal pressure is only a function of the liquid head or a combination of liquid head and vapor pressure.

REFERENCES

- ASME B31.3. *Process Piping*. American Society of Mechanical Engineers, New York, NY (1996).
- Barnes, H.L. Private communication, NASA Stennis Space Center (1995).
- Benz, F. J., C. V. Bishop, and M. D. Pedley. "Ignition and Thermal Hazards of Selected Aerospace Fluids: Overview, Data, and Procedures." NASA White Sands Test Facility, Las Cruces, NM (1988).
- Brown, W. F., Jr., H. Mindlin, and C. Y. Ho, Editors. "Aerospace Structural Metals Handbook." CINDAS/USAF CRDA Handbooks Operation, Purdue University, West Lafayette, IN (1996).
- Brzustowski, T. A., S R. Gollahalli, and H. F. Sullivan, "The Turbulent Hydrogen Diffusion Flame in a Cross-Wind," *Comb. Sci. Tech.*, 11(1-2), (1975).
- Chandler, W. T. and R. J. Walter, "Testing to Determine the Effect of High Pressure Hydrogen Environments on the Mechanical Properties of Metals," in *Hydrogen Embrittlement Testing*, ASTM 543, American Society for Testing and Materials, Philadelphia, PA (1974): pp. 170-197.
- Chandler, W. T., and R. J. Walter. "Hydrogen Environment Embrittlement of Metals and Its Control," *Hydrogen Energy*, Proceedings of the *Hydrogen Miami Energy Conference*, T. H. Veziroglu, Ed., Plenum Press (1975): pp. 1057-1058.
- Coley, G. D. and J. E. Field. "Role of Cavities in the Initiation and Growth of Explosions in Liquids." *Proceedings of the Royal Society of London Series A*, 335 (1600), (1973): pp. 67-86.
- Coward, H. F. and G. W. Jones. "Limits of Flammability of Gases and Vapors." Bureau of Mines Bulletin 503, N70-74476; AD-701575 (1952).
- Creitz, E. C. "Inhibition of Diffusion Flames by Methyl Bromide and Trifluoromethyl-Bromide Applied to the Fuel and Oxygen Sides of the Reaction Zone." *Journal of Research for Applied Physics and Chemistry*, 65A (1961): pp. 389-396.
- DoD 6055.9. "Ammunition and Explosives Safety Standards." Department of Defense, (1992).
- Durham, T. F., R. M. McClintock, and R. P. Reed. "Cryogenic Materials Data Handbook." Office of Technical Services, Washington, DC (1962).

- Gray H. R., "Testing for Hydrogen Environment Embrittlement: Experimental Variables," Hydrogen Embrittlement Testing, American Society for Testing and Materials, Special Technical Publication, ASTM STP-543, Philadelphia, PA (1974): pp. 133-151
- Groenvald, T. D. and A. D. Elcea. "Hydrogen Stress Cracking in Natural Gas Transmission Pipelines," *Hydrogen in Metals*, I. M. Bernstein and A. W. Thompson, Eds., ASM (1974).
- Grumer, J., A Strasser, J. M. Singer, P. M. Gussey, and V. R. Rowe. "Hydrogen Flare Stack Diffusion Flames: Low and High Flow Instabilities, Burning Rates, Dilution Limits, Temperatures, and Wind Effects," BM-RI-7457, Bureau of Mines Report of Investigation (1970).
- Hunter, G. W. "A Survey and Analysis of Commercially Available Hydrogen Sensors," NASA TM-105878, 1992.
- Hoover, W. R., et. al. *Hydrogen Compatibility of Structural Materials for Energy Storage and Transmission Applications*. Sandia National Laboratories, SAND80-8202, Livermore, CA February (1980).
- Jones, G. W. and G. St. J. Perrott. "Oxygen Required for the Propagation of Hydrogen, Carbon Monoxide, and Methane Flames". *Ind. Eng. Chem.*, 19 (9), (1927): pp. 985-989.
- Johnson, V. J., Ed. "A Compendium of the Properties of Materials at Low Temperature (Phase I)," WADD Technical Report 60-56, Part II, Properties of Solids, Office of Technical Services, United States Department of Commerce, Washington, DC (1960).
- Kent, G. R. "Find Radiation Effects of Flares," *Hydrocarbon Processing*. 47 (6), (1968): pp. 119-130.
- Lee, J. H., R. Kynstantus, C. M. Guirao, W. A. Benedick, and J. E. Shepherd. "Hydrogen-Air Detonations." Proceedings of the *2nd International Workshop on the Impact of Hydrogen on Water Reactor Safety*. M. Berman, Ed., SAND82-2456, Sandia National Laboratories, Albuquerque, NM, October (1982).
- Liebenberg, D. H., J. K. Novak, and F. J. Edeskuty. "Cooldown of Cryogenic Transfer Systems." *AIAA 3rd Propulsion Joint Specialist Conference*, AIAA Paper No. 67-475, Washington, DC, July 17-21 (1967).
- A. D. Little, Inc., "An Investigation of Hazards Associated with the Storage and Handling of Liquid Hydrogen," AD 324/94, A. D. Little, Inc., Cambridge, MA, March (1960).
- LNG Materials and Fluids: A User's Manual of Property Data in Graphic Format*, D. Mann, Ed., National Bureau of Standards, Boulder, CO (1977).

- McCarty, R. D., J. Hord, and H. M. Roder. *Selected Properties of Hydrogen (Engineering Design Data)*. NBS Monograph 168, National Bureau of Standards, Boulder, CO (1981).
- McClintock, R. M. and H. P. Gibbons. *Mechanical Properties of Structural Materials at Low Temperatures, A Compilation from the Literature*. National Bureau of Standards, Monograph 13, United States Department of Commerce, Washington, DC (1960).
- McHale, E. T., R. W. Geary, G. von Elbe, and C. Huggett. "Flammability Limits of $\text{GH}_2\text{-GO}_2\text{-Fluorocarbon}$ Mixtures." *Combustion and Flame*, 16 (2), (1971): pp. 167-175.
- Mellish, C. E. and J. W. Linnett. "The Influence of Inert Gases on Some Flame Phenomena." *4th Symposium (International) Combustion*, Baltimore, MD (1953): pp. 407-420.
- NFPA 50. "Bulk Oxygen Systems at Consumer Sites." National Fire Protection Association, Inc., Quincy, MA (1990).
- NFPA 51. "Design and Installation of Oxygen-Fuel Gas Systems for Welding, Cutting, and Allied Processes." National Fire Protection Association, Inc., Quincy, MA (1992).
- Novak, J. K. "Cooldown Flow Rate Limits Imposed by Thermal Stresses in Liquid Hydrogen or Nitrogen Pipelines." *Advances in Cryogenic Engineering*, Vol. 15, K. D. Timmerhaus, Ed., Plenum Press, New York, (1970): pp. 346-353.
- NSS 1740.12. "NASA Safety Standard for Explosives, Propellants, and Pyrotechnics." National Aeronautics and Space Administration, Washington, DC (1993).
- Ordin, P. M. "A Review of Hydrogen Accidents and Incidents in NASA Operations," In *9th Intersociety Energy Conversion Engineering Conference*, New York, ASME, 1974.
- Ordin, P. M., and R. C. Carter, "Clinch River Breeder Reactor Hydrogen Disposal and Ignition System," ARSD-00093, General Electric, June (1980).
- Payman, W. and H. Titman. "Limits of Inflammability of Hydrogen and Deuterium in Oxygen and Air." *Nature*, 137 (1936): pp. 160-168.
- Peterson, P. "Explosions in Flare Stacks," *Chem. Eng. Prog.*, 63(8), August (1967): pp. 67-70.
- "Properties of Teflon[®] at Cryogenic Temperatures," E. I. du Pont de Nemours and Co., Wilmington, DE (1976).
- Reed, R. P., R. E. Schramm, and A. F. Clark. "Mechanical, Thermal, and Electrical Properties of Selected Polymers," *Cryogenics*. February (1973): pp. 67-82.

- Robinson, S. L. "Hydrogen Compatibility of Structural Materials for Energy Storage and Transmission Applications." Sandia National Laboratories, SAND77-8240, June (1977).
- Rosen, B., V. H. Dayan, and R. L. Proffitt. "Hydrogen Leak and Fire Detection - A Survey." NASA SP-5092, Washington, DC (1970).
- Siegel, R. and J. R. Howell. "Thermal Radiation Heat Transfer. Vol 3: Radiation Transfer with Absorbing, Emitting, and Scattering Media." NASA SP-164: Vol. 3 (1971).
- Schwartzberg, F. R., S. H. Osgood, and R. G. Herzog. "Cryogenic Materials Data Handbook." Air Force Materials Laboratory, AFML-TDR-64-280, Supplement 4, Vol. II. Wright-Patterson AFB, OH, August, 1968.
- Stuhrke, W. F., and J. L. Carpenter. "Fracture Toughness and Testing Data - A Technology Survey." NASA-CR-134752, January, 1975.
- Wigley, D. A. and P. Halford. "Materials of Construction and Techniques of Fabrication." *Cryogenic Fundamentals*, G. G. Haselden, Ed., Chapter 6, Academic Press, London (1971).
- Williams, G. P. "Causes of Ammonia Plant Shutdowns." *Chemical Engineering Prog.*, 74 (9), (1978).
- Zalosh, R. G. and T. P. Short. "Comparative Analysis of Hydrogen Fires and Explosion Incidents." C00-4442-2, Factory Mutual Research Corp., Norwood, MA (1978).
- Zalosh, R. G. and T. P. Short. "Compilation and Analysis of Hydrogen Accident Reports." C00-4442-4, Factory Mutual Research Corp., Norwood, MA (1978).
- Zebetakis, M. G. and D. S. Burgess. "Research on the Hazards Associated With the Production and Handling of Liquid Hydrogen." BM-RI-5707, Bureau of Mines Report of Investigation, Washington, DC (1961).

APPENDIX H

INDEX

A

Acceptance test, 5-10
Access control, 4-23
Accident investigation, 7-1
Accidents, 1-4, 2-3, 2-6, 2-10, 4-21, 9-7
 Aerospace, 1-2, 1-3, 2-10, 3-3, 5-9,
 5-10, 10-2, 10-4, 10-6
Aerospace pressure vessels, 5-9
Aging, SLH₂, 2-26, 5-9
Annual review, 1-5, 10-4
Asbestos, 3-5, 9-2
Asphalt, 4-8
Attendant, 7-2, 8-6, 9-12
Autoignition
 temperature, 2-14
Autoignition, 2-14

B

Barges, 7-10
Barricades, 2-5, 4-25, 4-26, 4-27, 4-28
Barriers, 1-5, 4-29, 5-3, 5-11
Blast wave, 2-8, 2-18, 4-27
BLEVE, 2-4
Boiling point, 2-2, 2-24, 5-38
Bonding, 4-7, 4-10, 5-12, 5-16
Breathing Air, 2-21
Buddy system, 5-5, 7-1
Buildings, 4-11, 4-12

C

Cell
 test, 4-12, 4-16, 4-24, 4-25
Certification, 1-4, 1-5, 1-7, 4-3, 4-4, 4-5,
 4-32, 8-6
CHEMTREC, 8-3, 8-7
Class C, 4-20, 4-21
Cleaning, 5-36, 5-37, 7-2, 7-3, 7-4, 7-5,
 7-7, 8-6
Clothing, 7-6
Codes, 5-11
Cold trap, 5-39, 7-5
Collision, 1-6, 2-9
Combustion, 2-2, 2-6, 2-9, 2-12, 2-15,

2-20, 2-23, 4-10, 4-17, 4-29, 5-34,
5-35, 6-4, 6-6, 10-2, 10-4, 10-7
Compatibility, 1-1, 3-2, 3-6, 3-8, 4-20,
 6-2, 7-4, 10-7
Components, 1-1, 2-3, 2-4, 2-25, 3-4,
 4-2, 4-8, 4-9, 4-11, 4-14, 4-26, 4-32,
 4-33, 4-34, 4-37, 4-39, 5-1, 5-10,
 5-11, 5-12, 5-13, 5-15, 5-16, 5-23,
 5-28, 5-32, 5-36, 5-37, 5-39, 6-7, 7-3,
 7-6
 connections, 5-16, 5-23, 5-24, 10-3
 fittings, 5-16, 5-19
 flanges, 5-16, 5-19, 5-20, 5-26
 joints, 5-12, 5-16, 5-17, 5-18, 5-19,
 5-20
Concept design review, 4-3
Condensation
 air, 2-7, 5-4
Confined Spaces, 5-36, 6-3, 7-2, 8-6,
 9-11, 9-12
Confinement, 4-27
Connections
 transfer, 5-23, 5-24, 10-3
Contamination, 2-24, 4-22, 5-3, 5-7,
 5-24, 5-33, 5-36, 5-37, 5-38, 5-39,
 7-3, 7-6, 7-13
 control, 7-3
Continuous Evaporation, 2-24
Contraction
 thermal, 3-11, 3-12, 3-13, 5-14, 5-30
Control
 interconnected systems, 5-37, 5-38
Control room
 inert gases, 4-17
 piping systems, 4-16, 10-1, 10-3
 structure, 4-16
 ventilation, 4-14, 4-15, 4-16, 9-3
Control rooms, 4-16
Critical design review, 4-3
Cool down, 5-13, 7-11, 7-12
Cryogenics, 1-6, 3-1, 3-2, 3-4, 3-11,
 3-12, 3-13, 4-31, 4-35, 4-38, 5-1, 5-6,
 5-13, 5-14, 5-19, 5-22, 5-23, 5-27,
 6-4, 6-5, 7-2, 7-4, 7-6, 7-7, 7-11, 7-
 12, 8-1, 8-4, 9-3, 9-10, 9-11, 10-7

D

Decontamination, 7-6, 7-7
Deflagration, 2-4, 2-15, 2-16, 2-17, 2-20, 4-29, 5-36
 venting, 5-36
Deluge systems, 4-29, 4-31, 8-5
Density, 2-21, 2-25, 7-13
Design
 specification, 5-20
Design certification review, 4-3
Detection, 2-21, 4-35, 4-36, 6-1, 6-2, 6-4, 6-6, 6-7
 fire, 1-7, 4-29, 4-36, 6-1, 6-6, 6-7, 6-8, 10-7
 hydrogen, 4-17, 4-35, 6-1, 6-2, 6-4
 specifications, GH_2 , 6-2
 technologies, 6-4, 6-7
Detonation, 2-3, 2-4, 2-15, 2-16, 2-17, 2-18, 2-19, 2-20, 4-17, 4-28, 4-29, 5-35, 5-36
 cell size, 2-19
 limits, 2-18
 pressure, 2-17
Diaphragm, 2-5, 4-16
Diffusion coefficient, 2-23
Diffusion coefficient in NTP air, 2-23
Diluents, 2-13, 2-19
Dispersion, 4-27
Disposal
 burning, 5-34
 flare stacks, 5-34, 6-6
Documentation, 1-4, 4-3, 4-32, 7-1
DOT, 5-2, 5-3, 8-1, 9-7
 definitions, 8-1

E

Effect
 mechanical properties, 3-7
 temperature, pressure, and diluents, 2-19
Electric
 charge buildup, 2-26
Electric charge, 2-25, 2-26
Electrical
 equipment, 4-13, 10-5
Electrical considerations, 4-6
Embrittlement, 2-7, 3-6, 3-8, 3-9, 3-11
 reaction, 3-7, 3-10
Emergency

 fire and police departments, 9-7
 plans, 9-1
 procedures review, 4-4
 response, 8-2, 9-8, 9-11
 security, 9-7
 site personnel, 9-7
Emergency procedures, 1-1, 1-5, 4-4, 4-6, 9-1
 alarm system, 9-2
 fire suppression, ix, 9-7
 gas leaks from cylinders, 9-4
 general, 9-1
 GH_2 fires, 9-9
 incident command system, 9-2
 incident management system, 9-2, 10-5
 leaks
 controllable, 9-4
 uncontrollable, 9-4
 LH_2 fires, 9-9
 review, 4-4
 NASA specific elements, 9-1
 training, 1-4, 1-5, 7-1, 8-2, 9-11
Energy
 explosion, 2-20
 radiated, 2-22
Environmental, 3-6
Evaporation, 2-4, 2-5, 2-6, 2-24, 4-29, 5-3, 5-38
Examinations, 4-37
Exclusion area, 4-10, 4-15, 4-23, 9-7
 access control, 4-23
 placarding, posting, and labeling, 4-24
Exhaust, 2-6, 2-10, 2-17, 4-10, 4-24, 4-31, 5-36, 5-41, 6-3
Expansion, 2-2, 2-23, 3-12, 3-13, 5-7, 5-10, 5-12, 5-13, 5-14, 5-19, 5-20, 5-21, 5-22, 5-24
Explosion
 prevention, 5-36, 10-5
Explosive yields, 2-20
Exposure, 1-6, 2-9, 2-22, 2-23, 3-1, 3-2, 3-5, 3-6, 3-7, 3-8, 3-10, 4-18, 4-19, 4-30, 4-31, 5-13, 5-31, 6-4, 7-3, 8-7, 9-10, 9-11
 protection, 4-30
Eyewash fountain, 9-11

F

Facility
 design, 1-1, 4-3, 4-6, 7-7
 modification or rehabilitation, 4-4

Fail modes, 5-31

Fail-safe design, 1-7

Failure modes and effects analysis, 4-4

Filter, 5-6, 5-7, 5-37, 7-5

Fire, 2-4, 4-2, 4-31, 4-36, 6-6, 6-8, 8-6,
 9-7, 9-8, 10-1, 10-2, 10-5, 10-6, 10-7
 detection, 4-36, 6-6, 10-7
 explosions, 2-4
 extinguishing systems, 4-29, 4-31, 5-
 36
 protection, 4-2, 4-29, 10-1, 10-5, 10-6
 suppression, 4-29, 6-1, 9-8

First aid
 medical assistance, 9-10
 training, 1-4, 1-5, 7-1, 8-2, 9-11

Fittings, 5-16, 5-19

Flame
 temperatures, 1-6
 velocity, 2-21

Flame color, 2-22

Flammability, 2-4, 2-10, 2-11, 2-12,
 2-13, 4-9, 10-2, 10-3, 10-4, 10-7
 lower flammability limit, 2-11
 diluents, 2-13
 halocarbon inhibitors, 2-13
 pressure, 2-10, 2-14, 5-13
 temperature, 2-10
 upper flammability limit, 2-11
 air, 2-11
 diluents, 2-13
 halocarbon inhibitors, 2-13
 pressure, 2-10, 2-14, 5-13
 temperature, 2-10

Flammable liquid, 4-20, 4-28

Flanges, 2-5, 3-3, 4-34, 5-8, 5-10, 5-12,
 5-18, 5-20, 5-22, 5-23, 5-25, 5-26,
 5-27, 5-28, 6-2, 7-12, 7-13

Flare systems, 5-35

Flow
 controls, 1-6
 tests, 5-11
 velocities, 2-26, 5-20, 5-21

Fluid quantity measurements, 5-8

Forbidden materials, 3-5

Frostbite, 2-3, 2-24

G

Gaseous hydrogen system
 detection, 4-35
 piping, 4-22

QD
 nonpropellant, 4-19
 propellant, 4-20
 storage, 4-18
 venting, 4-15, 4-19

Gaskets, 5-25, 5-26

Gloves, 7-7, 9-10

Grounding, 4-7, 4-8, 5-4, 5-12

Grounding/Bonding, 4-7

Guard volumes, 5-8

Guidelines, 1-1, 1-2, 1-3, 1-4, 1-5, 1-8,
 3-2, 4-1, 4-6, 4-7, 4-12, 4-13, 4-18, 4-
 20, 4-21, 4-22, 4-23, 4-24, 4-29, 4-40,
 5-1, 5-2, 7-1, 8-4, 8-5

H

Halocarbon inhibitors, 2-13

Hazard
 analysis, 1-2, 4-4
 chemical, 1-4, 2-2, 7-1
 class, 8-1
 communication program, 1-5
 condensation, 2-7
 group, 4-20
 Group III, 4-20, 4-21
 health, 2-2
 physical, 1-4, 7-1
 physiological, 2-8

Helium, solubility, 2-6, 2-13, 2-26, 2-27,
 3-7, 4-13, 5-6, 5-8, 5-22, 5-34, 5-35,
 5-38, 5-40, 6-4, 7-6, 7-8, 7-9

High density, 2-25

Hoses, flexible, 5-20, 5-24, 7-5

Hydrogen
 air mixture, 2-11
 density, 2-21
 detection, 4-35
 detector installations, 6-5
 dispersion, 2-5
 environmental, 3-6
 fire detector installations, 6-8
 handling, training, 1-4
 internal, 3-6, 4-10

LH₂
 spills, 2-9, 2-21, 9-5, 9-6
 transfer, 7-3, 7-8

normal, 2-1, 2-2, 2-27
properties, 2-2
solid, 1-3

I

Ice, 2-24
Ignition, 2-4, 2-5, 2-7, 2-14, 2-15, 2-19,
4-9, 4-29, 5-3, 10-2, 10-6
hot objects, flames, 2-17
sources, 2-15, 4-9
Illumination, 4-11
Impounding areas, 4-28
Incident command system, 9-2
Incident management system, 9-2, 10-5
Industrial and aerospace accidents, 2-3
Inspection, 4-37
Installation pressure systems manager, 4-
1
Instrumentation, 4-34, 4-35, 5-8, 5-9
Insulation
failure, 5-14, 5-15, 5-32
Interface
safe, 1-6
Intraline separation, 4-22
Isolation valve, 4-5, 4-16, 8-4

J

Joints
bimetallic, 5-19
expansion, 5-13, 5-14, 5-20, 5-21, 5-
22
mitered, 5-18
silver braze, 5-18
soft solder, 5-19
threaded, 5-18
welded, 5-17

L

Labeling, 4-24, 4-32, 4-33
Leaks, 2-4, 2-5, 2-6, 2-7, 2-10, 2-25,
2-26, 2-27, 4-8, 4-16, 4-17, 4-26,
4-35, 4-39, 5-4, 5-6, 5-7, 5-13, 5-22,
5-26, 5-32, 5-35, 5-41, 6-1, 6-2, 6-3,
6-4, 6-5, 7-2, 7-8, 7-10, 8-5, 9-3, 9-4,
10-7
controllable, 9-4
uncontrollable, 9-4
Liquid hydrogen system
confinement, 4-27
QD

nonpropellant, 4-19
propellant, 4-20
Loading operations, 7-10
Loads
earthquake, 5-10, 5-12
operating pressure, 4-38, 5-22, 5-23,
5-25, 5-29
shock, 2-11, 2-18, 2-19, 4-13, 5-10,
5-12, 7-5
vibration, 5-10, 5-12, 5-26
weight, 2-9, 2-23, 4-21, 4-38, 5-7,
5-10, 5-12, 5-13, 5-40, 5-41, 7-5,
7-13
wind, 2-5, 4-30, 5-10, 5-12, 5-33, 6-3,
8-6
Location
piping and other hydrogen systems,
4-22
QD
GH₂, 4-18
LH₂, 4-19, 4-20
SLH₂, 4-22

M

Materials
clad, 3-4
class, 4-20, 4-21
control, 3-5
forbidden, 3-5
gasket, 3-4
general, 3-2
metallic, 3-2
nonmetallic, 3-3
properties, 3-4
selection, 3-1, 3-10
welds, 3-4, 5-17
Mechanical properties
low temperatures, 2-7, 3-5, 3-6, 3-7,
3-9, 3-10, 5-4
Minimum quantities, 1-3
Minimum spark energy, 2-14
Mishap reporting, 1-8, 10-6
Mobile storage, 5-2, 5-3, 5-5
Monitoring, 4-36

N

Nonpropellant, 1-1, 1-2, 1-4, 4-18, 4-19,
5-3, 5-4
Nonpropellant use, 1-2, 4-19

O

Operating procedures, 1-7, 4-5, 7-1, 7-2, 8-5, 10-3
 general, 8-5
 modifications, repairs, or decommissioning, 7-2
 personnel, 1-4, 1-5, 2-8, 4-9, 4-23, 4-24, 4-25, 4-39, 7-1, 7-2, 7-7, 8-2, 9-4, 9-5, 9-7, 9-11, 9-12
 repairs, alterations, and cleaning, 7-2
 special, 7-2
 standard, 7-1
Operational readiness review, 4-4
Operations
 loading, 7-10
Operator certification, 1-5
Organic cleaning solvent, 7-4
Other facilities, 1-3
Overpressure, 5-28, 5-33
 depletion, 9-11
 index, 2-23

P

Packaging, 8-1, 8-3
Personnel, 1-4, 1-5, 2-8, 4-9, 4-23, 4-24, 4-25, 4-39, 7-1, 7-2, 7-7, 8-2, 9-4, 9-5, 9-7, 9-11, 9-12
 training, 1-4
Physiological, 2-8
Piping, 4-32, 5-1, 5-10
 bending and forming, 5-15
 GH₂, 5-13
 LH₂ and SLH₂, 5-13
 supports, 5-14
 systems, 5-10
 transfer, 4-8
Pneumatic test, 4-38
Police department, 8-7, 9-7
Portable
 containers, 1-2, 4-24
 tanks, 8-2
Posting, 4-24
Preliminary design review, 4-3
Pressure
 rise, 2-24, 5-4, 5-14, 7-9, 8-7
 supplemental relief, 5-31
 vessel, 1-2, 1-3, 3-5, 4-1, 4-26, 4-32, 4-38, 4-39, 4-40, 5-1, 5-9, 5-10, 5-12, 8-2

Procedures

 cleaning, 7-4
 cool down, 5-13, 7-11, 7-12
 operating, 2-3, 7-1, 7-2
 purging, 2-6, 5-3, 7-3, 7-8
 storage, 7-7
 transfer, 7-7
Propellant use, 1-2, 4-20
Propellants, 1-1, 1-2, 1-3, 1-4, 4-17, 4-18, 4-20, 4-21, 4-22, 4-24, 4-25, 5-3, 5-4

Properties

 GH₂, 2-21
 density, 2-21
 diffusion, 2-23
 Joule-Thomson expansion, 2-23
 oxygen index, 2-23
 ice, 2-24
 LH₂, 2-24
 density, 2-25
 electric charge, 2-25
 evaporation, 2-24
 SLH₂, 2-25
 aging, 2-26
 electric charge, 2-26
 thermal acoustic oscillations, 2-26, 5-9
 thermal stratification, 2-26
 vapor pressure, 2-25
 volume change, 2-26
Protection, 4-2, 4-26, 4-27, 4-30, 5-37, 10-1, 10-5, 10-6
 fire, 4-2, 10-1, 10-5, 10-6
Protective clothing, 7-6
Pumps, 5-40
 vacuum, 5-8, 5-39, 5-40
Purging, 2-6, 5-3, 7-3, 7-8

Q

Quality control, 3-5
Quantities, minimum, 4-18
Quantity-distance (QD)
 guidelines, 4-17
 Compatibility groups, 4-21
 criteria, 4-18
 explosive equivalent, 4-21
 GH₂, 4-18
 LH₂
 nonpropellant, 4-19
 propellant, 4-20
 other, 4-22

- piping, 4-22
- SLH₂, 4-22
- Quenching distance, 2-14, 2-15, 4-11
- Quenching gap, 2-14

R

- Radiation, energy, 2-9, 2-22, 2-23, 2-25, 4-17, 4-30, 4-31, 5-4, 5-9, 5-34, 5-35, 6-7, 6-8
- Recertification, 4-37
- Records, 4-39
- Redundancy, 1-6
- Redundant Safety, 1-7
- Relief valves, 4-25, 4-32, 5-6, 5-8, 5-23, 5-28, 5-29, 5-30, 5-31, 5-32, 5-33, 5-37, 5-38, 7-10, 9-4
- Reporting, mishap, 1-8, 10-6
- Retroactivity, 1-4
- Roadways, 4-8
- Rupture discs, 5-30

S

- Safe interface, 1-6
- Safety
 - assessment review, 4-5
 - communication, 7-1
 - factor, 3-5, 4-3, 5-16
 - features, 1-6
 - redundant, 1-7
 - reviews, 1-7, 4-2
 - systems, 1-6
- Schedule, 4-40
- Security, 9-2, 9-8
- Set pressure, 5-28, 5-29, 5-31
- Shields and impoundment areas, 4-28
- Shipping, 8-1, 8-2
- Shock, 2-11, 2-18, 2-19, 4-13, 5-10, 5-12, 7-5
- Shoes, 7-7, 9-10
- Shutoff valves, 3-3, 5-2, 5-3, 5-23, 5-27, 5-37
- Site personnel, 9-7
- Slush, 2-1
- Solubility, helium, 2-27
- Spark generation, 4-9
- Spills, LH₂, 2-9, 2-21, 9-5, 9-6
- Standard, 2-21, 3-3, 4-22, 5-17, 5-19, 5-20, 5-22, 7-1, 8-4
- Storage
 - components, 4-32, 5-1

- fixed and mobile
 - GH₂, 5-2
 - LH₂, 5-3
 - SLH₂, 5-5
- LH₂ liquid propellant, 4-18
- nonpropellant use, 4-18
- tanks, 5-22
- transfer procedures, 7-7
- vessels, 2-6
- Stratified flow, 5-14, 7-12, 7-13
- Supports, 5-10, 5-12
- Surface
 - film, 3-8
- System safety analysis/safety review, 4-2
- System/subsystem hazards analyses, 4-4
- Systems
 - interconnected, 5-37
 - vacuum, 5-39
 - vent, 5-32

T

- Tagging, 4-32, 4-33
- Temperature, 2-14, 2-19, 2-22, 3-10, 3-11, 5-1, 10-4
 - air, 2-22
- Test chamber, test cell, or test stand, 4-12
- Test readiness review, 4-4
- Test/Testing, 1-3, 1-8, 3-1, 3-5, 3-6, 3-11, 4-3, 4-8, 4-9, 4-11, 4-12, 4-13, 4-16, 4-17, 4-23, 4-24, 4-25, 4-27, 4-33, 4-37, 4-38, 4-39, 5-5, 5-7, 5-9, 5-10, 5-19, 5-20, 5-22, 5-23, 5-24, 5-31, 7-10, 7-11, 8-6, 9-4, 10-2
 - system, 5-22
- Testing and Recertification, 4-38
- Thermal
 - acoustic oscillations, 2-26, 5-9
 - contraction, 3-12
 - cycling, 3-10, 5-7, 7-10
 - expansion, 2-2, 3-12, 3-13, 5-7, 5-10, 5-12, 5-13, 5-14, 5-19
 - radiation, 2-9, 2-22, 2-23, 4-17, 5-35
 - stratification, 2-26
- Toxicity, 3-1
- Transfer
 - piping, 4-8
- Transport, 2-10, 5-11, 7-10, 8-1, 8-2, 8-3, 8-4, 8-5
- Transportation, 1-1, 1-6, 2-9, 2-10, 8-1, 8-2, 8-4

- DOT definitions, 8-1
- emergencies
 - actions, 8-7
 - initial actions, 8-7
- NASA properties, 8-1
 - design, 8-4
 - site controlled, 8-4
 - special, 8-4
 - standard, 8-4
- public thoroughfare, 8-1
 - emergency response, 8-2, 8-3
 - requirements for GH₂, 8-3
 - requirements for LH₂, 8-3
 - training, 1-4, 1-5, 7-1, 8-2, 9-11
- Trapping sites, 3-8

U

- Unit conversion, 1-4
- Upward flame propagation, 2-11

V

- Vacuum systems, 4-32, 5-13, 5-39
- Valves, 2-4, 2-5, 2-6, 2-24, 3-4, 4-15, 4-24, 4-34, 5-2, 5-4, 5-5, 5-10, 5-12, 5-23, 5-28, 5-29, 5-30, 5-37, 5-38, 5-39, 6-2
 - safety, 5-28
- Vapor
 - cloud, 9-6

- pressure, 2-25
- travel, 4-28
- Vaporization, 1-6, 2-5, 2-7, 2-18, 2-26, 4-28, 5-5, 7-12, 9-5, 9-6
- Velocity
 - flame, 2-21
 - flow, 2-26, 5-21
- Velocity in NTP air, 2-22
 - Vent stack, 2-4, 2-6, 4-9, 4-20, 4-25, 4-31, 4-32, 5-33, 5-34, 8-6
- Vent and exhaust, 2-6
- Vent/Venting, 2-6 5-32, 5-33, 5-36, 8-6, 10-5
 - deflagration, 2-20, 5-36
- Ventilation, 4-14, 4-15, 4-16, 9-3
- Vessel, 4-32, 5-1, 5-2
 - aerospace pressure, 5-9
 - design, 8-4
 - mobile, 5-5, 8-6
 - support, 5-10, 5-12
- Volume change, 2-26

W

- Waivers, 1-8
- Warning systems, 1-6, 5-34
- Water spray systems, 4-29, 4-30
- Welding, 2-4, 2-10, 3-4, 3-9, 4-10, 4-11, 4-20, 4-37, 5-12, 5-16, 5-17, 5-18, 5-24, 6-6, 10-4